

TOOLS OF A LOCAL ECONOMY:
STANDARDIZATION AND FUNCTION AMONG SMALL CHERT TOOLS
FROM CARACOL, BELIZE

by

LUCAS R. MARTINDALE JOHNSON
B.A. University of Central Florida, 2001

A thesis submitted in partial fulfillment of the requirements
for the degree of Master of Arts
in the Department of Anthropology
in the College of Sciences
at the University of Central Florida
Orlando, Florida

Fall Term
2008

© 2008 Lucas R. Martindale Johnson

ABSTRACT

This thesis undertakes detailed analysis of a sample of 229 small chert tools from a single locus at the Maya site of Caracol, Belize. Emphasis is placed on determining the function of these tools and on the nature of their use in the broader Caracol economic system. Analysis sought to determine whether they were used for day-to-day household tasks or for specialized craft activity within the specified household locus and/or if they were prepared for broader distribution at Caracol. By focusing detailed analysis on artifacts from a single locus, greater insight is provided into the impact of household production on the overall Caracol economy. The thesis draws on traditional techniques of lithic analysis, while assessing tool morphology and chert reduction techniques; however, it is different from previous analyses in the Maya area in that it develops and applies specific quantifiable statistical methods (e.g., Chi-square and Coefficient of Variable) for particular tool type(s) used in the production and modification of crafts. Application of quantifiable methods and a detailed level of analysis helps to differentiate and determine chert tool variation or standardization, thus establishing ideal tool types within a craft production locus. The determination of the presence of standardization and ideal tool types elucidates that craft production was indeed taking place just outside the epicenter at Caracol and therefore suggests that not only were elites controlling the distribution of crafts via markets located at and along causeway and termini, but may have controlled the production of crafts as well. Future research aims to reanalyze tools from previously excavated craft production areas and also plans to test for the presence of additional crafting areas at or near the site's epicenter. A detailed analysis of a craft production locus and small chert flake tools reveals insight into the nature of the ancient Maya economy and into models of control over resources.

ACKNOWLEDGMENTS

This thesis would not be possible without the help of many important individuals. First, I would like to thank Dr. Jaime Awe and the Belize government for allowing the exportation of the lithic cultural material and second, Drs. Diane and Arlen Chase for their willingness and support with this thesis and allowing me to export and analyze lithic materials from Caracol, Belize. Without their determination and positivity this research would not be possible. I would like to thank all the members of the Caracol Archaeological Project (CAP) during the 2006 and 2008 field seasons. Specifically, Andrea Slusser whom excavated the lithic materials presented in this thesis. Next, I would like to thank Amy Morris whom provided the dusty box of lithic materials so that I would have something to do in the evenings. Her knowledge of what is actually on those rickety shelves is unparalleled. Other members of CAP that were critical in making this thesis possible include, James Crandall, Chris Cummargo, Jorge Garcia, Amanda Groff, Lisa Lomitola and Andy Tetlow. The tireless volunteers in the archaeology lab were also wonderful; thank you Kelin Flanagan and Vincent Scarcella.

I would like to acknowledge and thank Dr. Stacy Barber, Dr. Steven Brandt, and Dr. Bill Hildebrandt and the Far Western family for their expert knowledge and recommendations on statistics and research methods. Their guidance was vital in the development and execution of this research. I would also like to thank all the faculty, staff, and fellow graduate students at the Department of Anthropology for their positive support and guidance through this process.

Personally, it is important to recognize and honor Anabell Coronado Ruiz, Richard, Kathleen, and Marcus Johnson, the Sparks family, and other family and friends for their support and caring before, during, and after the research and writing of this thesis.

Dedicated to Ysa

TABLE OF CONTENTS

LIST OF FIGURES	vii
LIST OF TABLES	viii
CHAPTER ONE: INTRODUCTION AND HYPOTHESIS.....	1
Hypothesis.....	6
CHAPTER TWO: MAYA LITHIC STUDIES, CRAFT SPECIALIZATION, AND ECONOMICS	10
A Review of Maya Lithic Studies Past and Present	11
Craft Production and Economy: Important Concepts and Definitions	18
CHAPTER THREE: THE CONTEXT, MATERIALS, AND METHODS	25
Lithics and Crafts at Caracol: An Overview.....	25
The Gateway Group.....	30
Problems in Analyzing the Gateway Group	40
Lithic Materials	46
Methods of Analysis: Qualitative and Quantitative.....	50
CHAPTER FOUR: DATA, DISCUSSION, AND INTERPRETATION	60
Other Craft and Lithic Data from Caracol	72
CHAPTER FIVE: SUMMARY AND CONCLUSIONS	75
Suggestions for Future Research	79
APPENDIX A: TYPE 1-3 FLAKE TOOLS.....	81
APPENDIX B: TYPE 4 FLAKE TOOLS	87
APPENDIX C: TYPE 5 FLAKE TOOLS	89
APPENDIX D: IDEAL TYPE 5 (n=51).....	103
APPENDIX E: TYPE 6 FLAKE TOOLS	109
APPENDIX F: CHERT ARTIFACTS OF INDETERMINATE TYPE.....	111
APPENDIX G: FLAKE TOOL ANALYSIS KEY	117
APPENDIX H: ANALYSIS KEY DEFINITIONS.....	121
APPENDIX I: RAW DATA OF CHERT ARTIFACTS FROM SUBOPERATIONS C174C AND C174E FROM CARACOL, BELIZE 2008.....	130
REFERENCES	145

LIST OF FIGURES

Figure 1: Overview Map of the Maya Area.....	2
Figure 2: Map of Caracol, Belize with Epicenter Highlighted.	3
Figure 3: Map of Caracol Epicenter. The Gateway Groups is Circled and Causeways Labeled. ..	5
Figure 4: Sample of Lithic Artifacts from Caracol, Belize.....	26
Figure 5: Map of Gateway Group, Caracol, Belize Showing Locations of Excavations	32
Figure 6: Plan of Op C174C	33
Figure 7: Section of Op C174C	34
Figure 8: Lot Diagram of Op C174C Showing Excavation Subdivisions and Sampled Chert Lithic Material out of Total Amount Recovered	35
Figure 9: Plan of Op C174E.....	36
Figure 10: Section of Op C174E.....	37
Figure 11: Lot Diagram of Op C174E Showing Excavation Subdivisions and Sampled Chert Lithic Material out of Total Amount Recovered	38
Figure 12: Wooden Olmec Figure	41
Figure 13: Idealized Reduction Sequence.....	49
Figure 14: Showing Tool Types based on Plan Form.....	54
Figure 15: Type 5 Flake Tool with Side B Distal Rejuvenation Visual on Ventral Surface.....	63
Figure 16: Shows Actual Lengths of Side B Relative to Side D	66
Figure 17: Scatter Plot Type 3 Flake Tools (n= 17).	71
Figure 18: Scatter Plot Type 4 Flake Tools (n= 8).	71
Figure 19: Scatter Plot Type 5 Flake Tools (n= 146).	71
Figure 20: Scatter Plot Type 6 Flake Tools (n= 4).	71
Figure 21: Sample of Chert Tools from C174E/3 and Sample of “Drills” from C41A/2	73

LIST OF TABLES

Table 1: Hypothesized Household Function and Artifact Correlations.....	8
Table 2: Shows Context, Kind of Recovered Chert Lithic Materials, and Amount Sampled	47
Table 3: Hypothetical 2x2 Chi-Square Chart with Observed Frequencies.....	55
Table 4: Chi-Square 2x2 Chart on all Tool Types with and without Rejuvenation and Distal End Completeness.....	61
Table 5: Occurrence of Rejuvenation Flakes on Type 5 Flake Tools.....	63
Table 6: Summary CV Statistic Comparing Type 5 Flake Tools Separated by Distal Rejuvenation Flaking.	64
Table 7: Tool Type, Retouch Type, and Edge Angle between 0°- 90°	67
Table 8: Tool Type, Retouch Type, and Edge Angle between 60°- 90°	67
Table 9: Summary CV Statistics of Type 3 Flake Tools.....	69
Table 10: Summary CV Statistics of Type 4 Flake Tools.....	70
Table 11: Summary CV Statistics of Type 5 Flake Tools.....	70
Table 12: Summary CV Statistics of Type 5 Flake Tools with Distal Rejuvenation that are 1 SD of the Mean.	70
Table 13: Summary CV Statistics of Type 6 Flake Tools.....	70
Table 14: Summary CV Statistics of Drill Lengths.	74
Table 15: Summary CV Statistics of Drill Widths.....	74
Table 16: Summary CV Statistics of Drill Thicknesses.....	74

CHAPTER ONE: INTRODUCTION AND HYPOTHESIS

The study of flake stone tools in the Maya area ([Figure 1](#)) is situated within a craft production framework and, therefore, is economically important. Stone tools can be assessed both morphologically and statistically, depending on the questions being asked. In the Maya area stone tools often occur within household contexts and thus reflect different levels of craft activity. Craft activity or craft production can be measured at the household level by asking specific questions of the lithic material. Are there standards or ideal types of tools for different kinds of craft production areas? Quantifiable tests can be conducted on observable artifact features (Spaulding 1953, Blackman et al. 1993, Costin and Hagstrum 1995, Eerkins and Bettinger 2001, VanPool and Leonard 2002, Roux 2003). These tests can elucidate levels of craft production organization, while testing economic models for the ancient Maya.

Excavations at Caracol, Belize ([Figure 2](#)) are actively contributing to the study of ancient economic models for the Maya in terms of archaeological evidence regarding craft production and market loci (A. Chase and D. Chase 2004). Both of these economic elements are critical for an assessment of ancient economic activities (Costin 1991, 2001). In order to operationalize economic models for the ancient Maya, specific artifact assemblages must be analyzed in detail and must come from well- defined contexts. Detailed analysis demonstrates the extent that craft production took place and how those areas were integrated within an economic system via some form of exchange network (e.g. a causeway system).

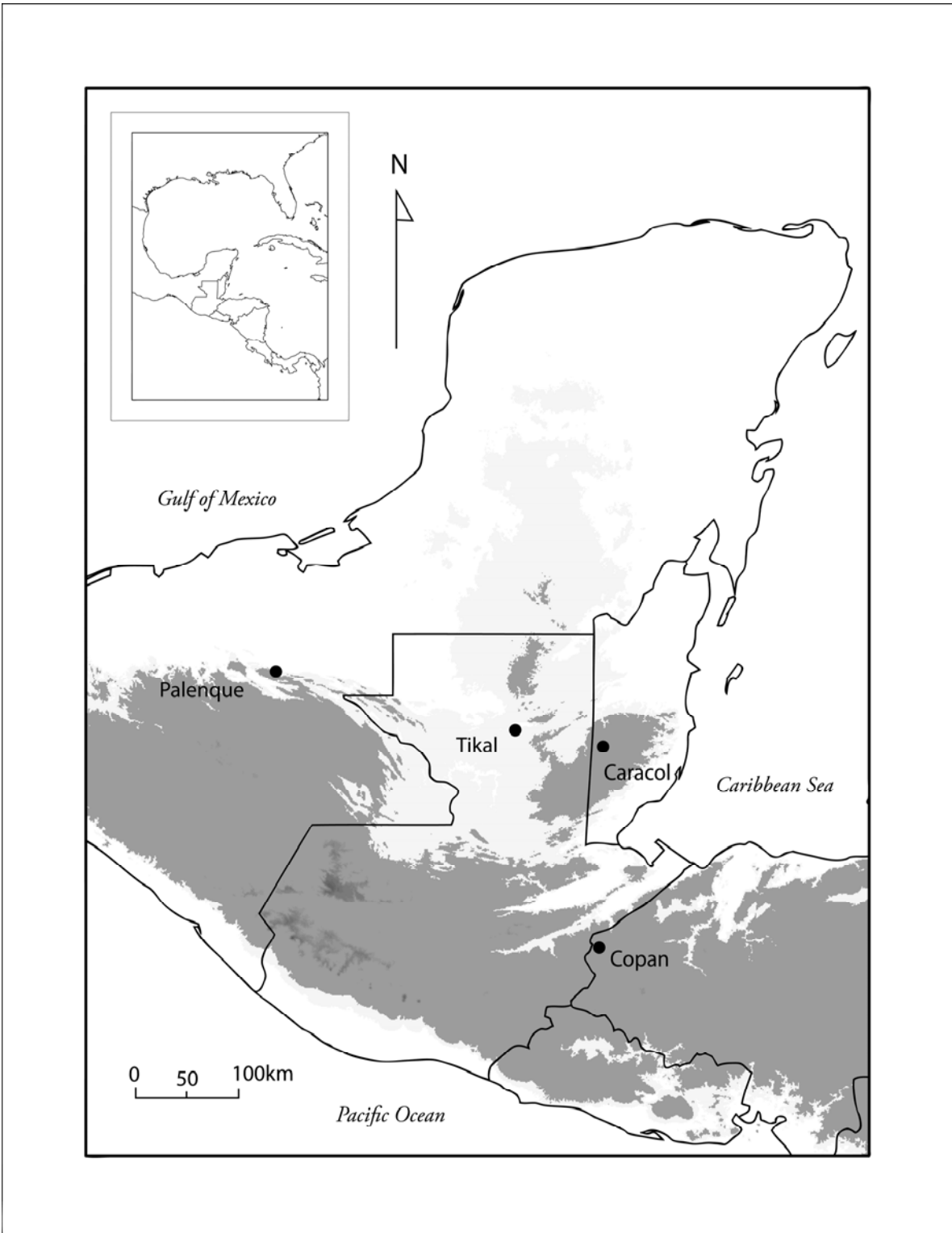
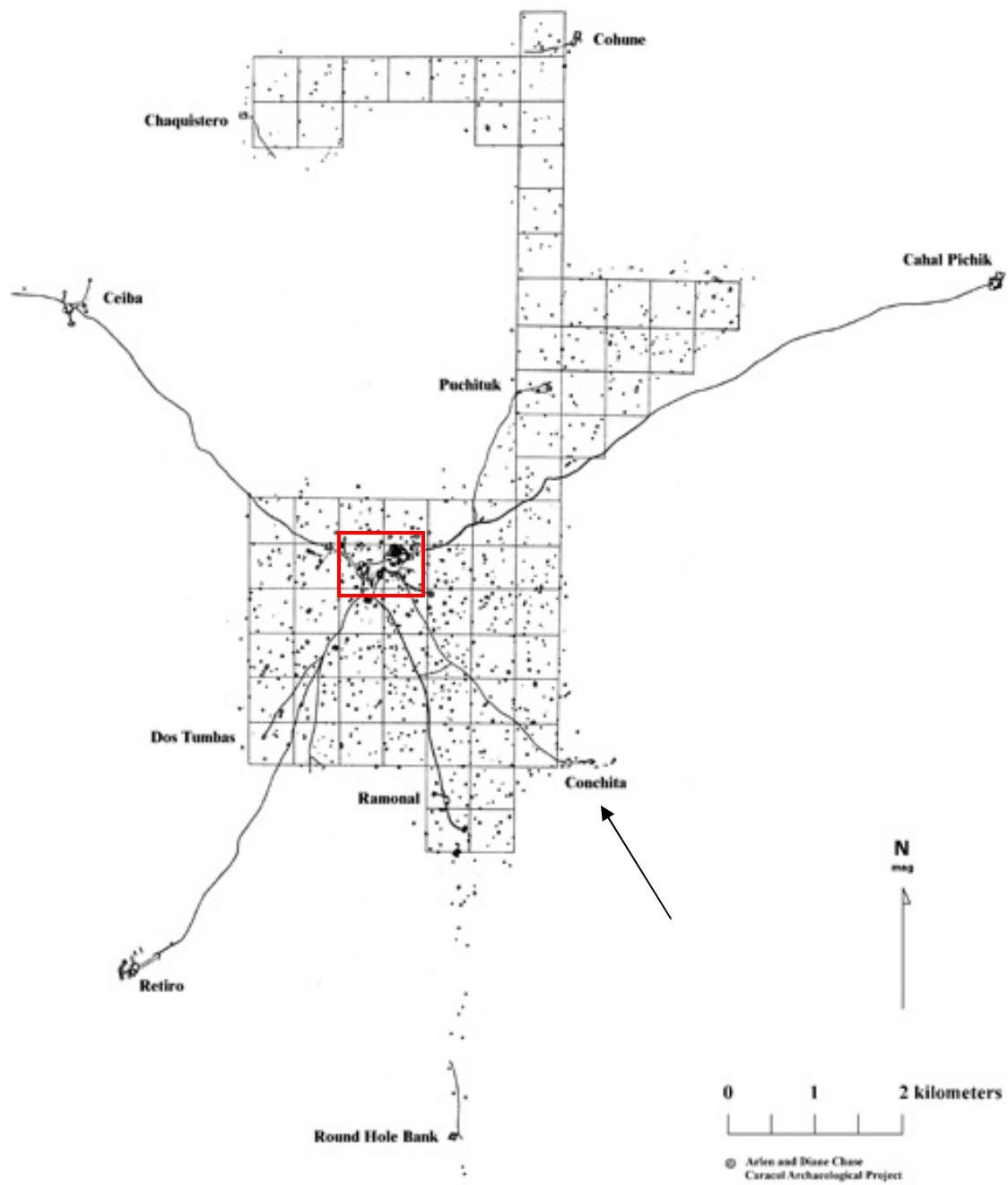

Figure 1: Overview Map of the Maya Area



*Figure 2: Map of Caracol, Belize with Epicenter Highlighted.
(from A. Chase and D. Chase 2001)*

Craft production areas at Caracol, Belize are found within household contexts dispersed throughout the site (A. Chase and D. Chase 1994, 2004). This thesis is concerned with one such residential group adjacent to the site's epicenter (see [Figures 3](#) and [5](#)). This group was excavated during the 2006 field season and revealed high amounts of chert flake stone material (see A. Chase and D. Chase 2006). The morphological characteristics of the assemblages recovered from the "Gateway Group" suggest levels of standardization within a particular tool type. The study of standardization is useful in assessing organizational qualities within a craft production system (Costin 1991, 2001, 2005, Roux 2003, Sinopoli 1988, Vanpool and Leonard 2002). Standardization studies along with other morphological features specific to flake stone also elucidate overall tool function within the production process. With this in mind, this thesis tests four basic hypotheses to determine household function based on the recovered lithic material (see [Table 1](#)).

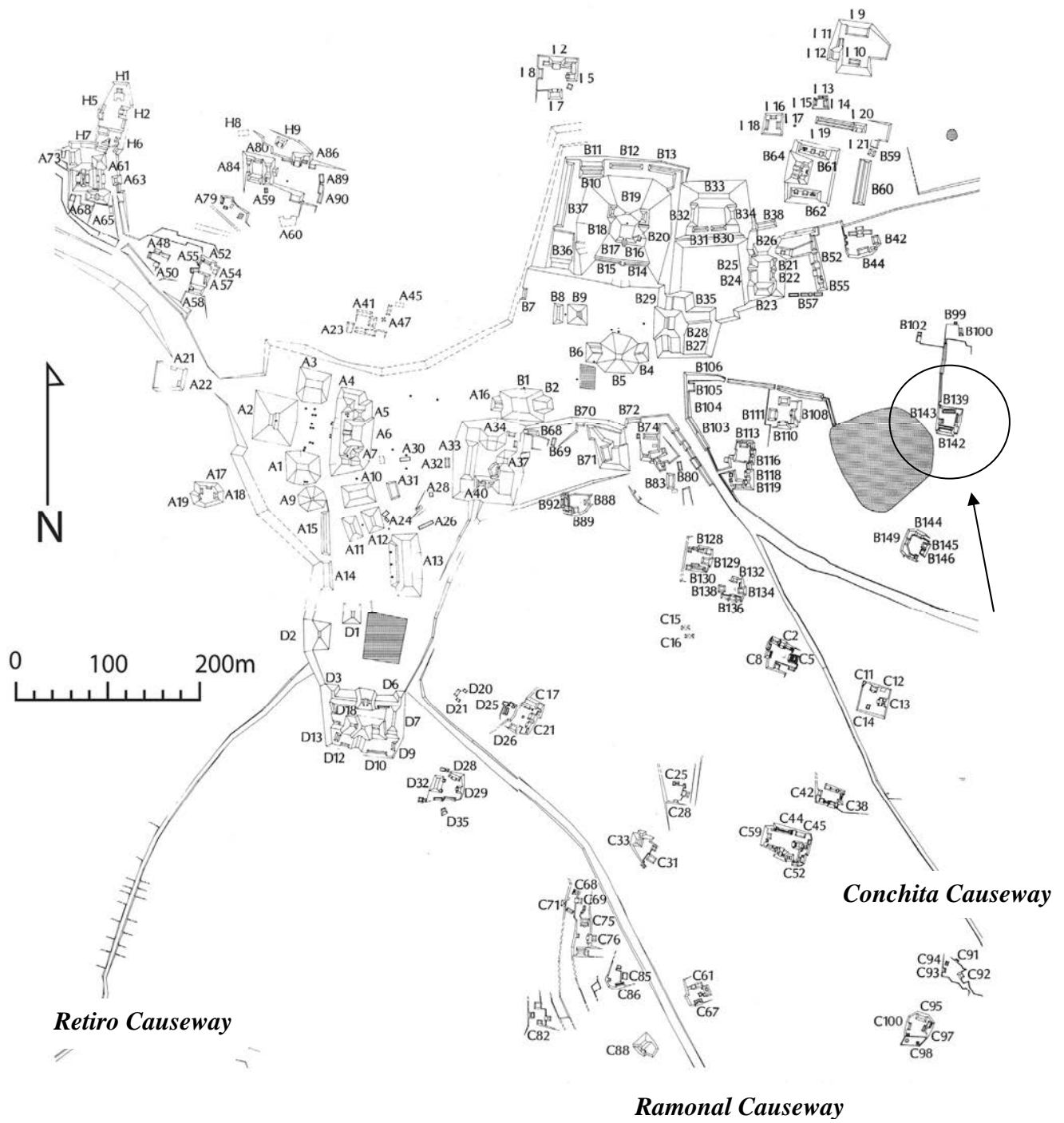

Figure 3: Map of Caracol Epicenter. The Gateway Groups is Circled and Causeways Labeled. (after A. Chase and D. Chase 1987)

Hypothesis

Santley and Kneebone (1993: 39-40) adapted earlier research (see Van der Leeuw 1976 and Peacock 1982) in order to create a holistic and heuristic list of properties by which to measure “craft production modes” in preindustrial contexts. Their research is due to the difficulty in accurately identifying modes of production archaeologically (see Table 1 in Santley and Kneebone 1993:40 and Costin 1990). They include four modes of production: 1) household production; 2) household industry; 3) workshop industry; and 4) manufactory or factory. In brief, they include a number of variables that signify the presence of one mode over another. A majority of the variables they list are seen archaeologically (e.g. product quality, distribution of production loci, and mode of waste disposal). For example, what would each mode of production reflect in terms of either tool or product standardization? In this case, general household production would be variable (no standardization), a household industry might be both variable and standardized, while workshop and factory contexts would have obvious standardization (Santley and Kneebone 1993: 40). This is only noticeable after a complete understanding of the artifact assemblage itself. It is important to recognize that applications to different ancient archaeological contexts would take into account relative scale and technical complexity. Similarly, Santley and Kneebone (1993: 39) state that “as with all multiattribute typologies, there may be a certain amount of overlap between adjacent categories.”

A multiattribute analysis is applicable here in that when tools or crafting implements and crafted items are found archaeologically in relatively high numbers as compared to other site assemblages, archaeologists need to be able to implement a set of variables by which the cultural context might be better defined (see Costin 1990, 2001, and 2005). The definition of this cultural and craft production context is based on morphological characteristics of the

assemblages, or chert tools in this case, as well as the location of the context itself relative to other cultural features on the landscape.

Therefore, four basic hypotheses were developed and are tested using small chert tools from a single house group to determine the nature of this household unit during the Late to Terminal Classic Period (AD 550- 900). For reasons explained later, it is assumed that all the artifacts included in this analysis were manufactured, used, and deposited within the same household unit. The variables in this thesis are: 1) the presence or absence of chert flake tool standardization; 2) the appearance of used tools in trash deposits; 3) the appearance of similar tools in other households at the site; and, 4) the appearance of either lithic or crafting debris in trash deposits. These variables are used to test if a particular household was producing: 1) craft items for day-to-day use; 2) specialized crafts for intra-household consumption; 3) lithic tools for extra-household distribution; or 4) crafts for extra-household distribution ([Table 1](#)). This can be simplified further by asking, “were activities at this locus done for use within the household or for use or exchange outside the household?” These questions are relevant in understanding how this household unit created wealth while not located near the terraced agricultural land at Caracol.

Table 1: Hypothesized Household Function and Artifact Correlations

<i>Production Context</i> ↓	<i>Variable</i>			
	Standardization	Used tools in trash deposit	Tools appearing at other households	Production debris (lithic and craft debitage) in trash
Day-to-day household use	Low	Low	High probability	Low
Specialized production within household	High	High	High probability	High
Lithic tool production for extra-household distribution	High	Low	Low probability	High
Crafts production for extra-household distribution	High	High	Low probability	High

The reasoning behind the variables presented in [Table 1](#) is based on the application of standardization studies, generally, (Arnold 1991, Blackman et al 1993, Eerkins and Bettinger 2001) and, specifically, on previous research and excavated craft production areas at Caracol (Pope 1994, Pope Jones 1996, A. Chase and D. Chase 2000, 2004, 2006, D. Chase and A. Chase 2004). The study of standardization is vital in determining the specialized nature of a craft assemblage (Costin 1991, 2001, 2005), meaning that if there is less variation or a high level of standardization within a tool or craft assemblage then it is deemed a useable variable in determining a level of craft production (Eerkins and Bettinger 2001).

Previously excavated materials (e.g., small chert tools and debitage and crafting debris) from Caracol, Belize justify the logic behind the three other variables in terms of determining the nature of production at the household level. For example, test pits (generally, 1.5m x 1.5m) placed within plaza areas at Caracol’s residential groups do not typically yield high amounts

(>100) of chert materials (Pope 1994, Chase and Chase personal communication 2007). However, when substantial amounts (>100) of chert materials are encountered in test pits, further excavation often uncovers associated crafting debris (e.g., shell, bone, slate) as well as high amounts of chert debitage and chert flake tools (Pope Jones 1996). These uncommon areas are indicative of the kind of household craft specialization that was present during the Late to Terminal Classic period at Caracol, Belize. Most of the prior research on these crafting areas previously excavated has focused attention on the chert tools themselves and not on the shell, bone, or stone artifacts *per se* (Pope 1994, Pope Jones 1996).

Current approaches to the study of craft specialization/production are not necessarily concerned with the tools of the craft production process, but rather focus more attention on the distribution, meaning, value (of crafts), and agents or people within the system (see Clark 2007). I propose an alternative approach to understanding the crafting process by assessing the tools of the craft production process specifically and, then, by determining their usefulness within an economic system. Although individual cases exist, lithic studies in the Maya area have not fully developed methodologies for analyzing these kinds of datasets, probably due both to the lack of research interest on lithic tools as an informative artifact assemblage, the lack of analytical standards, and to their occurrence in secondary deposits.

CHAPTER TWO: MAYA LITHIC STUDIES, CRAFT SPECIALIZATION, AND ECONOMICS

In general terms, lithic research in the Maya area incorporates any type of stone material (chert, obsidian, slate, limestone, granite, basalt, or jade) that can be quarried, transported, reduced (i.e. flaking, cutting, grinding, or polishing), traded or sold, used, reduced further, used again, and later thrown away; this is the life of a stone object. This thesis is concerned primarily with chert materials. From a quarry to a trash deposit, stone tools functioned in just about every corner of ancient Maya society. Attempting to sort hierarchically within a Maya political center, stone tools made of chert (and sometimes obsidian) were used to cut trees and quarry stones to build large and small architectural groups, carve stone monuments for public and private display, clear jungle to make temporary or permanent settlements in the periphery, form agricultural terraces to plant and harvest crops for consumption and exchange, and to hunt the local wildlife. Quite literally, stone tools were the essential part of the construction and maintenance of any evolving ancient Maya settlement for over two millennia.

Although vital on a macro-scale as stated above, stone tools also functioned within much of the space they were used to create. Maya priests and other elites used obsidian blades for ritual purposes and skilled knappers created beautiful chert eccentrics that depicted rulers and effigies for use in ceremonial contexts (Hruby 2007, Meadows 2001). The larger or more general population (an effort is made here to not use the term “non-elite” because this research is not concerned with the social status of craft specialists) knapped alternative forms of these same materials for use in the day-to-day operations within a domestic or household unit. The uses of stone tools in these contexts are critical for understanding how the general population functioned together both socially and economically – and maybe even spiritually. In other terms, lithic

studies are forever tied to discussions of how and why the Maya created and transformed their world through the use of stone tools, the modification of other materials, and/or the production of crafts for economic exchange. This section is intended to situate the current research within past and present research paradigms, like those of craft production and household economics at ancient Maya sites.

A Review of Maya Lithic Studies Past and Present

Initial research on lithic assemblages from the Maya area was mainly analytical and descriptive, providing the basis for typologies still in use today (Ricketson 1937, Kidder 1947, Coe 1959, Proskouriakoff 1962, Willey et al. 1965, Willey 1972, Lee 1969, Stoltman 1978). This research, like much of Maya archaeology, was concerned with culture history (see Sheets 1977 for a review) and, therefore, temporal and descriptive aspects of lithic assemblages were the main focus; there was little mention of cultural value, agency, or esoteric knowledge of production. In this past vein, Mayanists still publish complete artifact inventories (e.g. Hansen 1990, Taschek 1994, Moholy-Nagy 2003, Kaneko 2003) or make data available on the project web sites (A. Chase and D. Chase 2006, 2007 www.caracol.org).

Because lithic artifacts were not often of central concern to many research questions in the Maya area, the above resources set ethical standards for archaeologists and created accessible data that should have facilitated site-to-site comparisons and uniform description. Sheets (1977) and Clark (see Hirth 2003 Appendices A-E) both created holistic databases, presenting a bibliography of lithic research in Mesoamerica. These bibliographies and the aforementioned published artifact inventories are enormously helpful in providing a complete summary of research on lithic analysis, experimental studies, and ethnoarchaeological research in Mesoamerica as

whole. Field reports and published bibliographies represent the most comprehensive attempt in the Maya academic community to gather data together and make it available, benefiting everyone. These earlier lithic studies laid the ground work for our current understanding of lithics in Maya archaeology, becoming a catalyst for expanding our understanding of craft specialization and ancient economies both socially and politically.

The first major effort by lithic specialists to compare data – with an eye toward broader understanding – was during a 1976 Field Symposium in Belize. This symposium produced a collection of papers published by the University of Texas at San Antonio (Hester and Hammond 1976). In this publication, Sheets (1976: 1-9) explored what research areas were known and unknown in terms of lithics and the then current understanding of the ancient Maya. He surveyed regional studies and expressed a desire to understand trace element analysis, regional trade networks in prehistoric times, general technological analysis, and Paleo-Indian research. Sheets (1976: 4) concluded by stating: “The needs for future research are numerous; in fact the needs are so vast and varied as to be discouraging, were it not for the fact that lithic analysis is rapidly becoming an integral component of Mesoamerican research programs.”

During this field symposium, the Maya archaeological community was introduced to Thomas R. Hester and Harry J. Shafer. These two scholars would forever impact how anthropologists would think of lithic production and exchange in Northern Belize. Hester (admittedly not a Mayanist [Hester 1976: 11]) disagreed with single specimen research (e.g. eccentrics) and recognized four aspects of chert lithic research for the Maya area, based on his previous experience in the North America. Hester (1976: 12) noted: “1) the problem of artifact description; 2) the need for functional analysis of lithic implements; 3) the need for studies of the lithic manufacturing process; and 4) the necessity for intensive studies at sites specifically related

to the lithic production process.” Interestingly, there is no mention of culture in these research questions.

Other papers from this conference summarized lithic manufacture and meaning (Shafer 1976), site area and density at Colha, Belize (Wilk 1976), the development of utilitarian lithic artifacts in the Yucatan (Rovner 1976), movements of stone tools across the geographic landscapes over time (Sheets 1976, Hammond 1976, Johnson 1976), the spatial distribution of lithic artifacts at Tikal (Moholy-Nagy 1976), obsidian production (Michels 1976), and the pre-ceramic occupation in northern Belize (Miller 1976). The following year, Sheets assessed the state of lithics in Mesoamerica once again and presented a current bibliography on lithic studies by positing (1977: 150),

“...we can expect to see lithic analyses of improving descriptive and illustrative quality in site reports and in individual articles. Lithic analysts are broadening their techniques and emphases to include debitage, trace-element, microwear, and behavioral analyses...loci of performing and later stages of manufacture, occupational specialization, territoriality and access or ‘ownership’ of resource areas, politico-economic expansion and the formation of cartels, and the internal redistribution network of manufactured implements.”

Furthermore, he (1977:151) also calls for a standard terminology in all aspects of lithic research, noted the urgent need for ethnoarchaeological studies of the Lacandon Maya in Chiapas, Mexico, and succinctly summarized that lithic research is beginning to illuminate “what aboriginal peoples were doing, why they were doing it, and why they changed.” This intuitive and optimistic perspective was due in part by his work at Chalchuapa, El Salvador (Sheets 1978).

Although the 1976 conference directly contributed to the development of lithic studies in the Maya area, more than a decade would pass before another conference of this type would take place (Hester and Shafer 1991). In the time between the first and second Maya lithic

conferences scholars were beginning to understand Mesoamerican lithics from both a culture-historical and processual framework (Fowler 1991: 1-2). This meant that archaeologists were not directly concerned with change over time, technology, or distribution, but rather how lithic artifacts functioned within ancient Maya settlements. As a result, in the second lithics conference, simply titled *Maya Stone Tools*, researchers described flake stone taxonomy (Potter 1991, Sheets 1991, Hester and Shafer 1991, Aldenderfer 1991) and technology and production (Shafer 1991, Mitchum 1991, Clark and Bryant 1991, Fedick 1991, Thompson 1991), but also included a separate section dealing with tool function and cultural relationships (Eaton 1991, Gibson 1991), experimental studies (Lewenstein 1987, 1991a, and 1991b), and ethnoarchaeological studies of the Lacandon (Clark 1991, Hayden 1987).

Shafer and Hester's (1983, 1986, 1991, Hester and Shafer 1992, 1988) primary work pertaining to Maya lithics was at the site of Colha in northern Belize. Their publications discussed technological trends in large chert workshops in Northern Belize and also initiated debate over the nature of Maya chert workshops and the archaeological record (see Shafer and Hester 1986, Malloy 1986, Moholy-Nagy 1990, Healan 1992). These debates centered on formational processes in the archaeological record, mainly "C-transforms" (Sharer and Ashmore 2003: 128). Moholy-Nagy (1990) argues that Mayanists, and archaeologists, must never assume that cultural deposits are in primary contexts. The premise is that lithic debris or debitage made from the reduction process is often transported to secondary deposits due to site maintenance in antiquity and that micro-debitage might be the best indicator of a production area as it is usually too small to remove completely (Moholy-Nagy 1990). Following Moholy-Nagy (1997), archaeologists need to understand how a site is formed and what reliable indicators of production areas are; the Maya often moved production debris of all kinds in order to build new architectural

works. Yet this secondarily deposited material is often the only evidence for craft production and organization in the archaeological record (Moholy-Nagy 1997, Pope 1991). This is indeed the case for the assemblage under analysis in this thesis. Secondary deposits are problematic, but often retain strong evidence of primary production activities.

The research at Colha was of obvious importance on a regional scale as well. Colha had huge trash piles of reduction debris, indicating that the site was a major production locale for lithic tools (Shafer and Hester 1983). Other work in Northern Belize (e.g., D. Chase and A. Chase 1988, Santone 1997) demonstrated that Colha was the source for much of the chert being traded and transported to other sites in Northern Belize – and potentially to the entirety of the eastern Maya lowlands (McAnany 1989). McAnany (1989) was concerned with defining the “consumer” of much of the chert in Northern Belize. In what form did it enter into different sites (e.g., raw material, large biface, or finished tool)? These were and are important questions regarding access to resources over time and for considerations of regional complexity in economic and social organization. Sourcing cherts deposits is critical for assessing any regional scale of exchange; however, sourcing can be problematic due to heterogeneity of chert deposits; as a result, sources outside of northern Belize are more difficult to regionally analyze.

Recently, Maya scholars have advocated another, more regional, focus to lithic studies, while simultaneously moving away from strict studies of trace-element data or “minute technological analysis” (see Braswell 2004:190). These regional studies deal primarily with the exchange of obsidian and do not generally include chert materials. Regardless of material type, a regional study of access, trade, and exchange of lithic resources and other resources (e.g., jade; see Kovacevich 2007) creates theoretical models of ancient society and may illuminate social hierarchies. If social hierarchies can be juxtaposed with environmental diversity – and, thus,

access and control over resources – this may suggest developmental models in terms of craft production and cultural complexity not only for the Maya area but also for other parts of both the New and Old World (Lewis 1996, Clark and Parry 1990, see Wailes 1996).

The aforementioned evolutionary focus creates a robust theoretical discussion that can have applicability throughout the global archaeological and anthropological community and may be relatable to present-day society. Much of this research is not concerned with the materials that make a craft *per se*, but rather deals with questions directed at control over resources, power, agency, identity, social class distinction (elite and non-elite models) or inequality and control over access to resources (attached and independent specialization), ideology, gender, household function, and economy in ancient civilizations (A. Chase et al. 2008, Arnold and Munns 1994, DeMarrais et al. 1996, Earle 2001, Hayashida 1999, Hendon 1996, Janusek 1999, Mills 1995, Schortman and Urban 2004, Sinopoli 1988, Vaughn 2006). A complete discussion of each of the above topics is beyond the scope of this research (see Costin 2001 for a comprehensive discussion); however, the point being made here is that research on lithic technology – or any technology used to produce crafts – must be concerned with exactly how those crafts functioned within an ancient population relative to their political, economic, and social hierarchies/heterarchies (i.e., theoretical models of ancient society; Costin 2001). Characteristics of crafting and cultural complexity are not surprisingly dynamic and multi-faceted in scope and application to archaeology.

There are, however, important studies that should be mentioned as they may elucidate future trends in lithic and craft specialization studies for the Maya area. Aoyama (2007) demonstrates probably the most recent attempt at incorporating technological assessment of stone tools within a theoretical model at the Maya site of Aguateca, Guatemala. Following the

assumption that the site was rapidly abandoned (Inomata 2003), Aoyama (2007) implements rigorous experimental microwear analysis on stone tools in order to test for types of crafts produced or materials being worked based on striation patterns. Because the striations are indicative of certain materials, he infers that a certain social class or “royal family” was producing crafts in different social contexts and therefore may have “processed multiple social identities” (Aoyama 2007: 25). This combination of technological assessment within a theoretical model of the Maya creates a clear synchronic view and should be a goal of all lithic analysts. Although more theoretical, Hruby’s (2006, 2007) discussion of the “ritualized production” of obsidian eccentrics and their deposits at Piedras Negras, Guatemala, is also important. Hruby (2007:68) is concerned with how “religion structured social practice” in terms of craft production and how those craft items may have played a part economically.

It is important to make a distinction between the above studies in terms of their usefulness in assessing ancient Maya economy as a whole. While both studies have economic value, each differs depending on the function of the crafts within ancient social contexts. Aoyama’s study describes non-lithic craft production by elite for the elite and does not consider the scale or exchange of these items for other goods or services within a general economic framework (e.g., markets). Hruby’s study demonstrates that the lithic item itself is the craft that is used in an ideological context and that the individual making these ideological symbols is the agent of exchange apart from other exchange systems.

Although these studies are stimulating in terms of technological and theoretical assessment, they do not consider how a single craft production area is defined devoid of the craft material itself (e.g., bone or shell); the characteristics of that area based on the application of particular statistical methods to small chert tools; and, how this evidence may be used to test for

tool standardization, while simultaneously elucidating household function within a larger social and economic context. To be sure, the craft specialists are important agents in this process, but if we neglect to fully understand the assemblage itself, we may fail at describing the craft specialists and their place within society.

Craft Production and Economy: Important Concepts and Definitions

The study of craft specialization/production is theoretically and methodologically diverse. Costin (1991, 2001, and 2005) devotes much effort to defining the nature of craft specialization and operationalizing characteristics in the archaeological record in terms of cultural complexity, sociopolitical process or evolution, and social relationships and the meaning of craft objects. Even though she creates and advocates holistic categories for assessing craft specialization, it is understood that alternative cultural or archaeological contexts put some definitions and concepts before others. More recently, Clark (2007) critiques this holistic systems approach by stating: “Our categories of craft specialization still represent generic summaries of typifying behavior of constituent human entities involved in subsystems [craft production]. Current questions require we break into these venerable subsystems and acknowledge the faces and hands really involved.” Clark’s major critique with previous work, including his own, is the lack of theoretical frameworks in the understanding of labor, agents, technology, production, goods, exchange, organization, and consumption (2007: 21); he concedes that theoretical movements in these areas are still being “worked out.” Costin (2007: 146) disagrees with these movements and provides criticisms.

Realistically, the operationalization of definitions into on-the-ground reality is critical for testing, locating, and interpreting craft production areas prior to any theoretical application (see

Costin 2007). This has initiated some debate over recognizing and interpreting the craft production system as opposed to determining the actual “players” or agents of that system. This thesis recognizes the reflexive nature of the latter, but is concerned with the former perspective; I would argue that understanding the agents of a system is *only* possible after a full assessment of the contextual archaeological material. In support of such a position, Costin (2007:145) strongly asserts,

It is the challenge and bane of archaeology that we infer the intangible qualities of social existence largely from tangible things and the concrete physical relationships among them. Thus, it is incumbent upon archaeologists to not just define what something ‘is’ or ‘means’ but to address explicitly how can it be recognized in the archaeological record. While we need to be mindful of the intangible qualities of things and relationships, if we cannot operationalize the defining criteria of our objects of interest, just how successful can we be *as archaeologists?*

I will not attempt to resolve the above issues, for recent perspectives have formed from decades of research and thought. The intention here is rather to summarize a number of fundamental aspects in the study of crafting in ancient society that are relevant to this thesis. Because this thesis is data heavy and deals primarily with the tools and by-products of craft production, not the products per se, it is obvious that larger theoretical perspectives (i.e., agency and value) will need to be tabled. Both of the above perspectives are more than separate heuristic devices; taken together, they aid in understanding the archaeological record (i.e., artifacts), the organizational aspects of ancient society (i.e., crafting), and the individual agents within an ancient system (i.e., a craft person or the agency of the craft itself; see Clark 2007: 30-31). This latter aspect is the most difficult to see archaeologically.

As stated above, Costin (2001) presents a myriad of definitions and facets regarding craft specialization, examining the producers, means of production, organizing principles of

production, the objects themselves, mechanisms of distribution, and the consumers. Realistically, the application of all these subjects to the data here would prove overwhelming. Therefore, it is important to stay on track and only discuss applicable particulars, such as; 1) the unit of production (e.g., the household); 2) the organization of production vis-à-vis standardization; 3) and the modes of exchange, or what Costin (2001) refers to as “mechanisms of distribution.” By using these terms, the following brief discussion can be operationalized archaeologically and has little to do with the actual agents or people in the production and the exchange process. Understanding that alternative modes of exchange may exist for different types of crafts (elite goods vs. non-elite goods) implies that different social relationships also existed in the form of control over production and distribution by individuals or groups. This is essential when assessing the scale, flexibility, and method(s) by which ancient people have interjected tangible goods into their local (e.g., A. Chase and D. Chase 2004, Aoyama 2007) or regional (e.g., Kovacevich 2007, Barrientos and Demarest 2006) economies.

In terms of processing lithic materials, a unit of production must be defined relative to the cultural context under examination; however, ethnographically and archaeologically, a unit of production often refers to functional dynamics of the household. Hirth (1993: 22) provides a functional definition of a household as “a task-related residential unit.” Definitions such as these are inherently economic in their application to the archaeological evidence of production; for the ancient Maya most activities took place in or around the household.

Households have synchronic and diachronic dimensions as they respond to social, political, or economic changes in order to adapt. Spatial placement or proximity to important cultural (e.g., markets) or physical landscape features (e.g., quarries) is vital to understand how households adapt and exist economically (Hirth 1993 and 1998, Hendon 1996, Wells 1996). I

will not summarize all the research undertaken on defining households both archaeologically and ethnographically, but rather would make the point that, in the case of the ancient Maya at Caracol, the household or house group was where the majority of non-agrarian craft production took place (A. Chase and D. Chase 1994, D. Chase and A. Chase 2004). To be sure, family or extended family relationships were important in the development and execution of a successful household and certain households were involved in extra-household production. Hirth (1993: 33) states: “The co-resident household was the primary economic unit, and it supplied the majority of the needs for food, fiber, and craft goods in the society.” It is understood that a primarily economic focus on the creation and maintenance of a household for the Maya area ignores important dynamics, such as gender and division of labor (Aoyama 2007), the role of the individuals or important agents (Kovacevich 2007), and age-graded hierarchies (Hendon 1996). But, given the large distribution and scale of house groups at sites like Caracol and Tikal, Guatemala, I argue that it is likely that some households were formed without regard for and separate from kinship ties. They may have developed for specific economic reasons (these households may have been short lived and represent full-time, temporary units of production); the Gateway Group at Caracol may be one such example. This is contrary to long generational diachronic shifts in some household models (see Hirth 1993).

Once archaeologists locate a unit of production, they must next consider how a household is organized in terms of production. The household organization of production has been given economic significance (as noted above), but how is the organization of production operationalized or measured archaeologically? Costin (2001) situates the organization of production into two basic areas of research: the geographic or regional extent of organization (e.g., trade networks) or, alternatively, a specific physical context (e.g., household organization).

The latter can be subdivided further into spatial and social constituent parts and can be assessed by measuring particular features of the archaeological record (Costin 2001: 293).

Craft tool standardization is one measurable feature present in the artifactual materials of at least one house group from Caracol, Belize. Costin (2001: 301) states: “The degree of standardization in an assemblage is often invoked to infer principles of organization in the production system, both spatial and social.” Standardization in artifact assemblages may also be a “proxy for the relative number of artisans” in that high standardization reflects few craft persons (Costin 2001: 301-302). Obviously standardization is one of many ways to assess the organization of production (see Costin 2001), but if nothing remains in terms of the craft itself and only the tools are present, archaeologists must be able to make the most of that particular data set. Standardization can be both qualified and quantified to determine degree of organization in a household or within a craft industry. Standardization studies have proven effective in assessing the production of utilitarian ceramic wares in domestic households and in the determination of alternative labor forces in the production of imperial or politically important ceramics (see Costin and Hagstrum 1995). Ceramics are particularly important for standardization studies as vessels cannot only be measured for morphological features but also for stylistic features. Measuring standardization in crafts has also elucidated particularly functionally effective utilitarian crafts within a community (VanPool and Leonard 2002). Most standardization studies look at finished products themselves and not a specific tool industry. It is obvious that the tools that produce crafts are also crafts themselves.

After the organization of production is assessed using a particular criteria (in this case standardization), a determination must next be made as to the relevance of that household’s economic significance within a larger community; therefore, the mechanisms of distribution

must be considered to create a holistic picture of the full reach of the craft production process (i.e., from the craftsperson to the consumer). The economic significance of the household may be determined on two fundamental levels. The first is a household's ability to produce items for extra-household distribution, while the second is the ways in which the items or crafts are exchanged or distributed outside of the household or production unit to the consumer (Costin 2001). Costin (2001: 304) states that "...the term 'distribution' refers to both the mechanisms/processes for transferring material goods between individuals and to the spatial patterns that result after goods are transferred." These spatial patterns can include the actual locations of the exchange (e.g., markets). Costin (1991:1) asserts that "...exchange seems to receive more systematic attention in the archaeological literature." This is surprising, especially considering that units of production or households are vital in understanding and determining the exchange system itself. The mechanisms of distribution and exchange of artifacts are inexorably tied to the unit of production or household.

Exchange systems are arguably relative to a given level of cultural complexity. Rather than summarizing literature related to defining alternative economic models such as reciprocity, redistribution, market exchange, and exchange between different social classes (see Polanyi 1957, Earle 1977, Costin 2001), it is more relevant to explain the economic model pertinent to the research in hand. A. Chase and D. Chase (2004: 117-121) argue for the presence of markets at Caracol based on two fundamental criteria: 1) the archaeological presence of physical structures which were constructed at or near causeway termini and within the epicenter to form the markets themselves and 2) the physical presence of "workshops" or craft production loci outside these market locales. Caracol's causeways are vital to this economic model as they integrate the urban sprawl that comprises most of Caracol's large population (A Chase and D.

Chase 2007a, Diane Chase and A. Chase 2004); therefore, Caracol's ancient economy may be studied in terms of production and distribution systems (A. Chase and D. Chase 2004). Obviously, production units are the focus here; thus, the data recovered from them aid in the testability of a proposed economic system. This has applicability to facets of production or to the degree or intensity of production, to the tools used and crafts produced, and to the spatial distribution of production areas relative to exchange locations or markets. Current archaeological data show patterns in how Caracol may have been organized economically and socially; markets are vital to this organization.

In summary, the above review explored the transitions in lithic research in the Maya area and explained how lithic studies can operate within a craft specialization framework, thus contributing to our understanding of household production and its importance to ancient Maya economic systems. The next sections will summarize the lithic research at Caracol, Belize and describe new data from one house group at the site. The subsequent analysis is aimed at defining variation and standardization within this single craft production locus and at testing economic models for the ancient Maya. This study makes a substantial contribution to our understanding of the Terminal Classic economy at Caracol, Belize.

CHAPTER THREE: THE CONTEXT, MATERIALS, AND METHODS

Lithics and Crafts at Caracol: An Overview

Lithic materials from Caracol, Belize represent a diverse sample of forms. They include obsidian and chert blades and eccentrics found in cache deposits and other primary or secondary deposits (e.g., Chase and Chase 2007b); obsidian and chert cores, chunks (angular waste), flakes, and formal tools ([Figure 4](#)). The local chert at Caracol is typically grainy and contains many inclusions. Nodules are generally fist sized (Chase and Chase personal communication 2007) and therefore large tools are rarely encountered. Both obsidian and chert are commonly found in excavations. When chert is found in high (>100) amounts at the site, it usually occurs in association with other debris (e.g., shell or bone) (A. Chase and D. Chase 1994, 2000, and 2006). These contextual materials (both lithic and craft debris) have been used to indicate a high or intensive level of craft production at the site (Pope 1994: 148-156, Pope Jones 1996, A. Chase and D. Chase 1995, 2000, 2006).

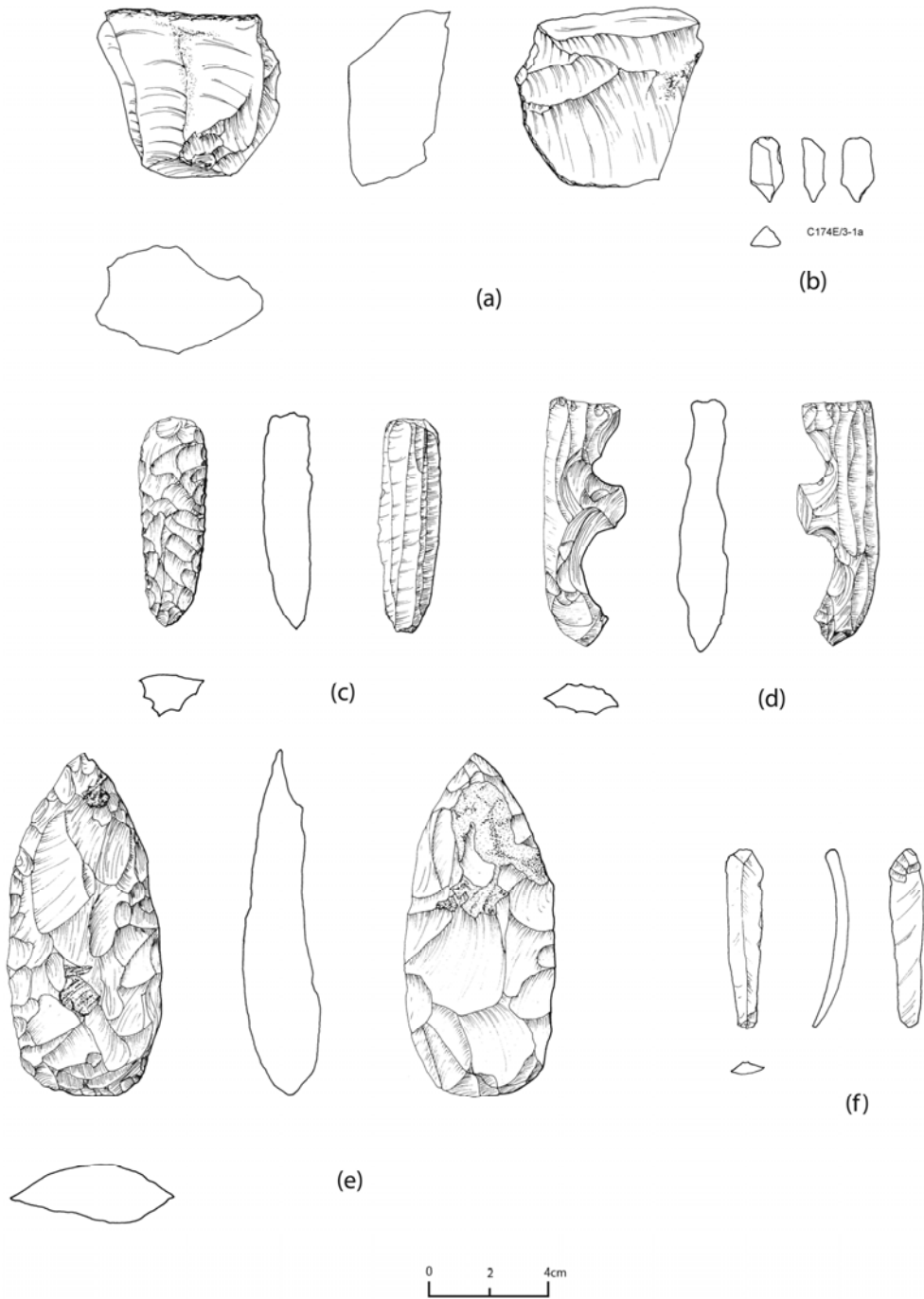

Figure 4: Sample of Lithic Artifacts from Caracol, Belize. a) chert core, b) chert flake tool, c) obsidian core, d) obsidian eccentric, e) chert biface, f) obsidian blade (from A. Chase and D. Chase 2007)

Like other Maya sites, lithic material at Caracol functioned within at least two basic realms; ritual and economic. These realms are probably the most intriguing in terms of the patterning of archaeological materials in the Late to Terminal Classic period. Particular types of obsidian eccentrics, known as “the Caracol E”, have been found in relatively large numbers (>20) placed inside cache vessels along with other precious materials. Along with “the Caracol E” are other obsidian eccentrics made from spent obsidian blade cores (Chase and Chase 2007b). The symbolic or iconographic importance of these items is unclear at the moment, but it is important to note that initial observations point out that there may be an association between the reduction sequence of the eccentric and the cache deposit itself. Were these eccentrics created in such a way as to function within a particular cache vessel? The meaning of this is currently unclear, but intriguing. Research on this topic is forth coming.

Flaked stone has been recovered similarly from a number of burial contexts. Differing from pottery inclusions in burials, lithic material is sometimes associated with the construction or sealing of the tomb burial. During the excavation of a tomb in Structure A3, researchers recorded 8,913 pieces of obsidian and 7,840 of chert above the tomb vault (A. Chase and D. Chase 1987: 15). For another tomb 4, 946 pieces of obsidian blocked an entryway (D. Chase and A. Chase 1996: 68). This indicates that flaking stone either functioned spiritually for the interred individual, the interment ceremony as a whole, or may have functioned to discourage the reentry of the burial itself. Either way, these deposits of flaked stone functioned in conjunction with other ritual elements during the interments of important individuals. Pope Jones (1996: 70) describes a special deposit in Caracol Structure B19 on the summit of Caana:

“Special Deposit SDC4C-1 included pottery vessels, censers, and a carbon sample located above a cut made through a plaster floor. A large quantity of small chert tools and related debitage were deposited in the cut through the plaster floor. The chert consisted of 216 drills, seven trimmed flakes, 28 cores, 30 primary cortex removal flakes, 177 secondary cortex removal flakes, 393 tertiary flakes, and one piece of shatter.”

This primary deposit is one example of how non-obsidian, “utilitarian” chert material was symbolically important.

Lithic materials were fashioned into formal tools in order to manufacture crafts at the site. A number of craft production loci have been observed at the site and most of these contexts include large amounts of lithic debitage, formal tools, and debitage from the craft production process (see A. Chase and D. Chase 2004, Cobos 1994, Pope 1994, Teeter 2001,). Even more specifics regarding these data is summarized in Pope (1994), Pope Jones (1996), and A. Chase and D. Chase (2006: 14-18), which demonstrates the intensity of craft production that took place in different areas of the site during the Late and/or Terminal Classic Period. As a whole, this production is characteristic of complex societies and is an indicator of economic complexity (Costin 2001, Clark and Parry 1990).

In terms of economic complexity, A. Chase and D. Chase (2004: 117) assert that “Intimately tied to any consideration of economics are the presence or absence of markets.” Excavations at Caracol along causeways and at causeway termini have uncovered potential market locales (A. Chase and D. Chase 2004). A. Chase and D. Chase (2004:117-118) state,

“Each of the known termini also contains a broad open plaza that was once lined by low, long linear buildings on their edges... [and these] plazas and buildings that comprise the causeway termini reveal that both plazas and structures are largely lacking in artifactual remains and that neither locale yields the burials and caches so common in Caracol’s residential groups”

If markets or exchange locales are present at these nodes, they could have controlled the distribution of crafts produced at the household level (D. Chase and A. Chase 1998, A. Chase and D. Chase 2004).

Equally important, I would argue, are units that provide markets or exchange locales with surplus, specifically the craft production loci. If one feature is present, then the other must exist to some degree. The nature of this existence, spatial arrangement, and scale is of relevance here. Archaeologically, production loci have been identified both in the palaces and within nondescript residential groups up to 1.5 kilometers south of the epicenter (A. Chase and D. Chase 2004). Inferring craft production at these locales is based on the presence of high amounts of both lithic debris and sometimes the craft debris (Pope 1994, Pope Jones 1996, A. Chase and D. Chase 2004). Lithic materials include chert flakes tools (e.g., drills) of a specific morphology and are similar to the tools presented in this thesis, while crafting debris includes both shell (e.g., *stombus* and *spondylus*) and bone (Cobos 1994, Pope 1994). Shell was an important commodity to many Maya elite, but given the placement of craft production areas outside of the site's epicenter it is likely that craft production was taking place outside of elite control. A. Chase and D. Chase (2004: 122-123) assert that "the ancient Maya elite at Caracol maintained administrative control of distribution at market locales...but not the means of production."

Let us now turn to the description of one context specifically and then return to the larger economic question once the data is presented in Chapter Four.

The Gateway Group

A. Chase and D. Chase (2006: 14) describe the subject of this thesis, the “Gateway Group,” as being “literally on the border of the site epicenter.” The Gateway Group, excavated in 2006, includes Structures B139-B143 and the arrangement and construction techniques of this group are similar to others at the site (Chase and Chase 2005). This group is “characterized by long low structures on its northern, eastern, and southern sides,” while the western building is also low but substantially smaller in overall area ([Figure 5](#)). Low platforms, like those in these groups, probably supported perishable superstructures. The Gateway Group is located adjacent to Reservoir C and approximately 300 meters east of the Conchita Causeway. This group defines the southern limit of the west epicentral wall (A. Chase and D. Chase 2006:14) (see [Figure 3](#)). Although this group is architecturally similar to other groups, the high amount of chert lithic materials recovered from within particular excavations (see below) is uncommon at Caracol.

The majority of data in this thesis comes from within the western platform forming Structure B143 (Suboperation C174E). Associated with this western building was a discrete depression that was indicative of an underground chamber or *chultun*. Such features can contain both trash and burials (Hunter-Tate 1994: 64-75), although alternative functions have been posited (Puleston 1971, Dahlin and Litizinger 1986). The archaeological material that forms the basis for this research comes from both Structure B143 and its associated chultun. Suboperation C174C, which was a 2.0 m N/S by 1.5 m E/W excavation, was placed over the localized depression or *chultun* just north of Structure B143; this investigation removed the majority of the cultural material from within the chultun ([Figures 6, 7, and 8](#)). Suboperation C174E was a 1.5 m

N/S by 2.5 m E/W axial excavation through Structure B143 ([Figures 9](#), [10](#), and [11](#)). A full description of the flake tools recovered from these excavations is given in Chapter Four.

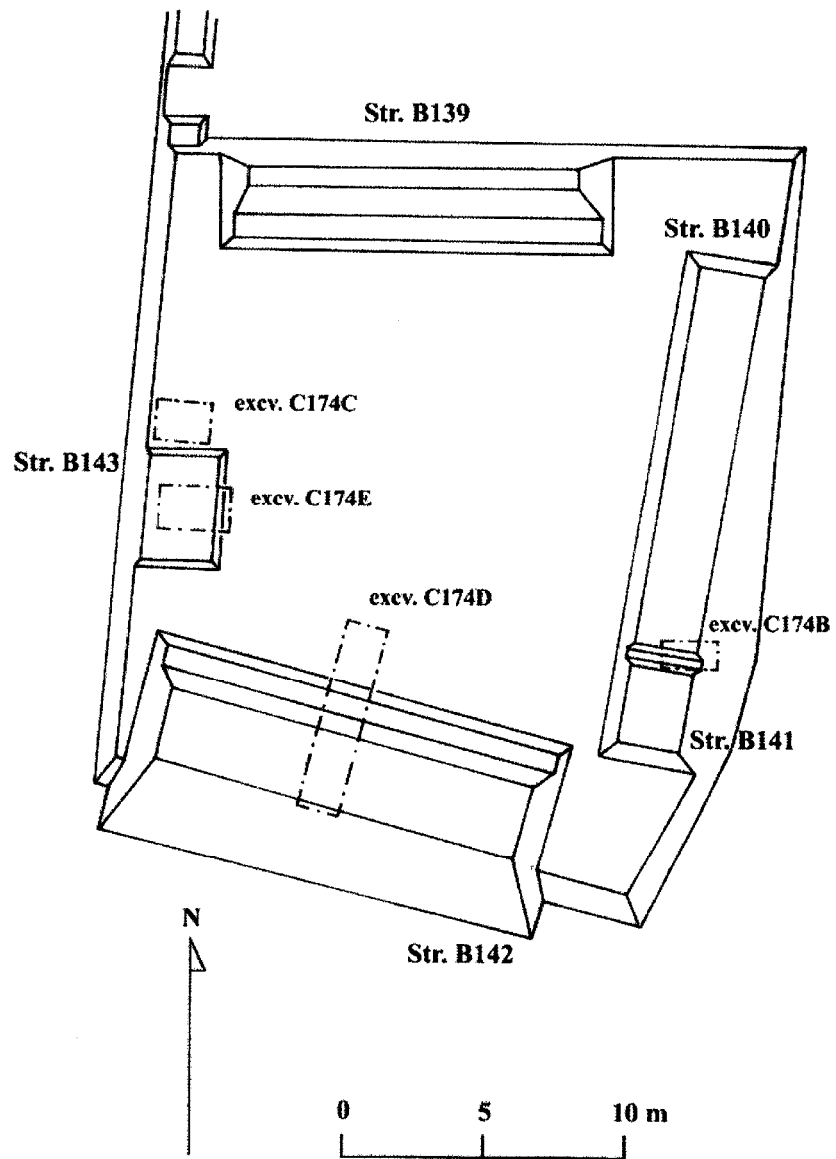

Figure 5: Map of Gateway Group, Caracol, Belize Showing Locations of Excavations (from A. Chase and D. Chase 2006)

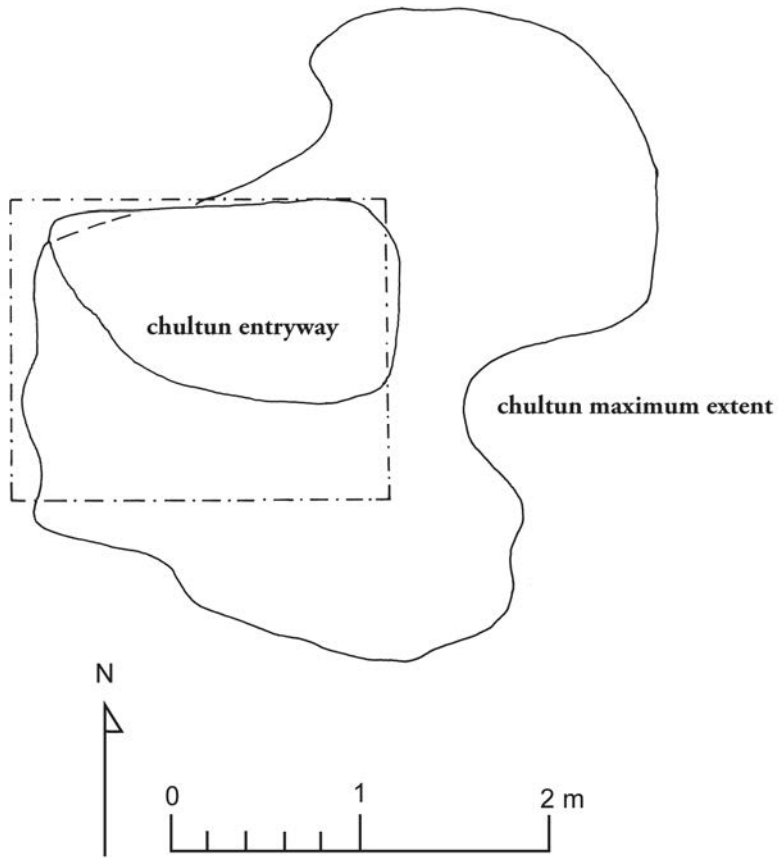

Figure 6: Plan of Op C174C (after A. Chase and D. Chase 2006)

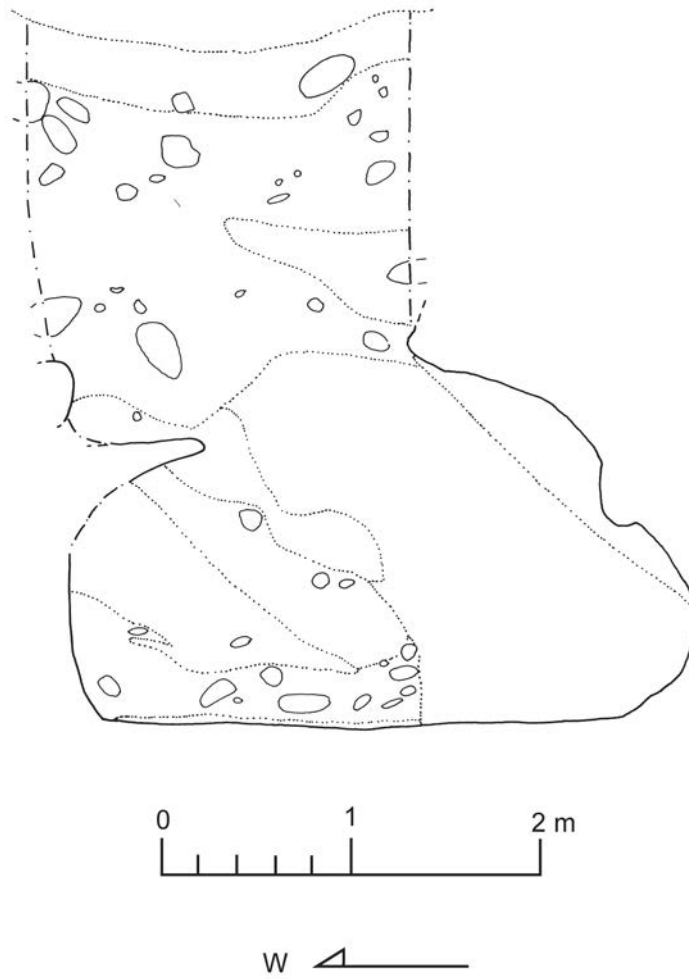

Figure 7: Section of Op C174C (after A. Chase and D. Chase 2006)

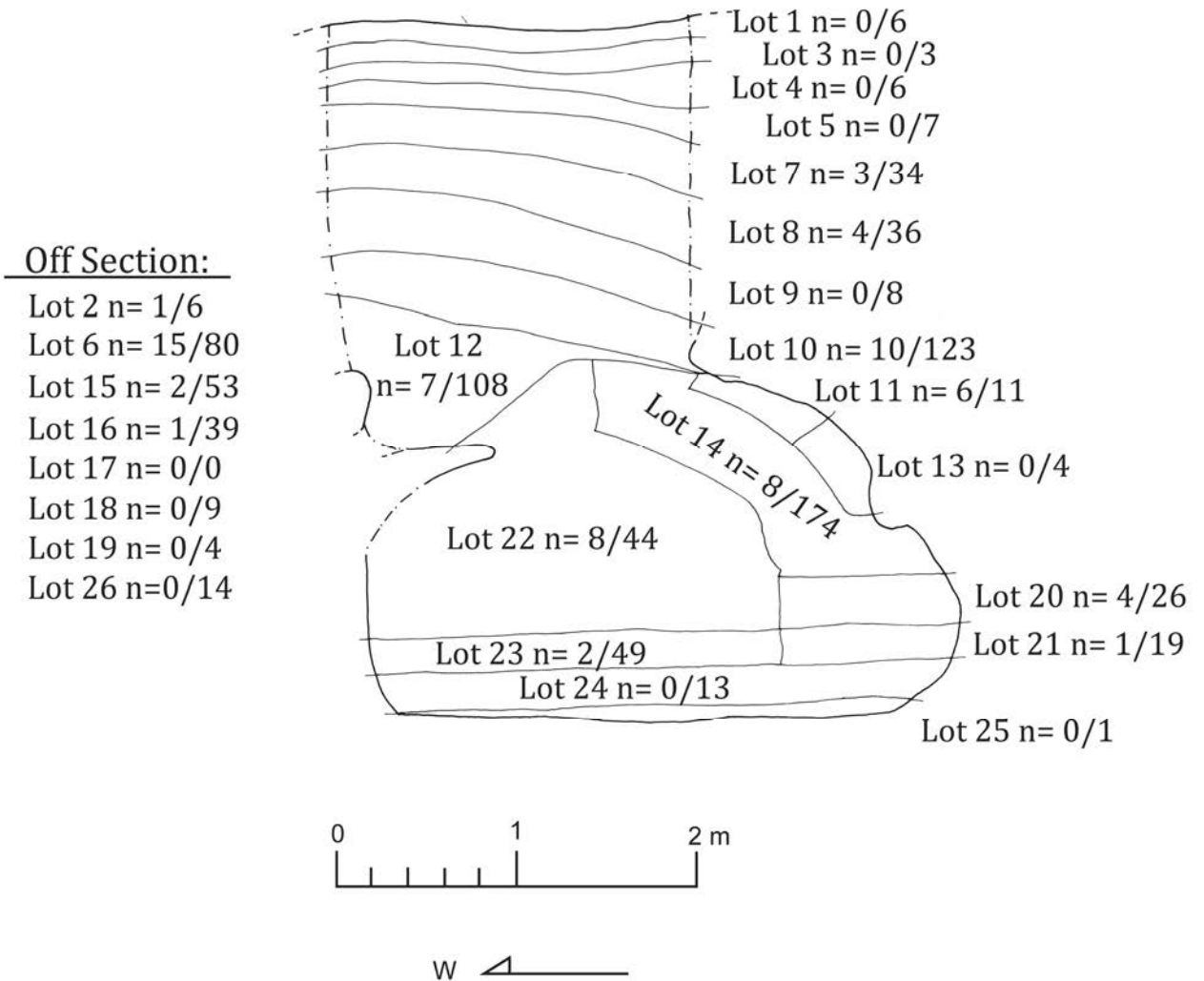

Figure 8: Lot Diagram of Op C174C Showing Excavation Subdivisions and Sampled Chert Lithic Material out of Total Amount Recovered. Off Section Lots are Adjacent to Closest Number. (after A. Chase and D. Chase 2006)

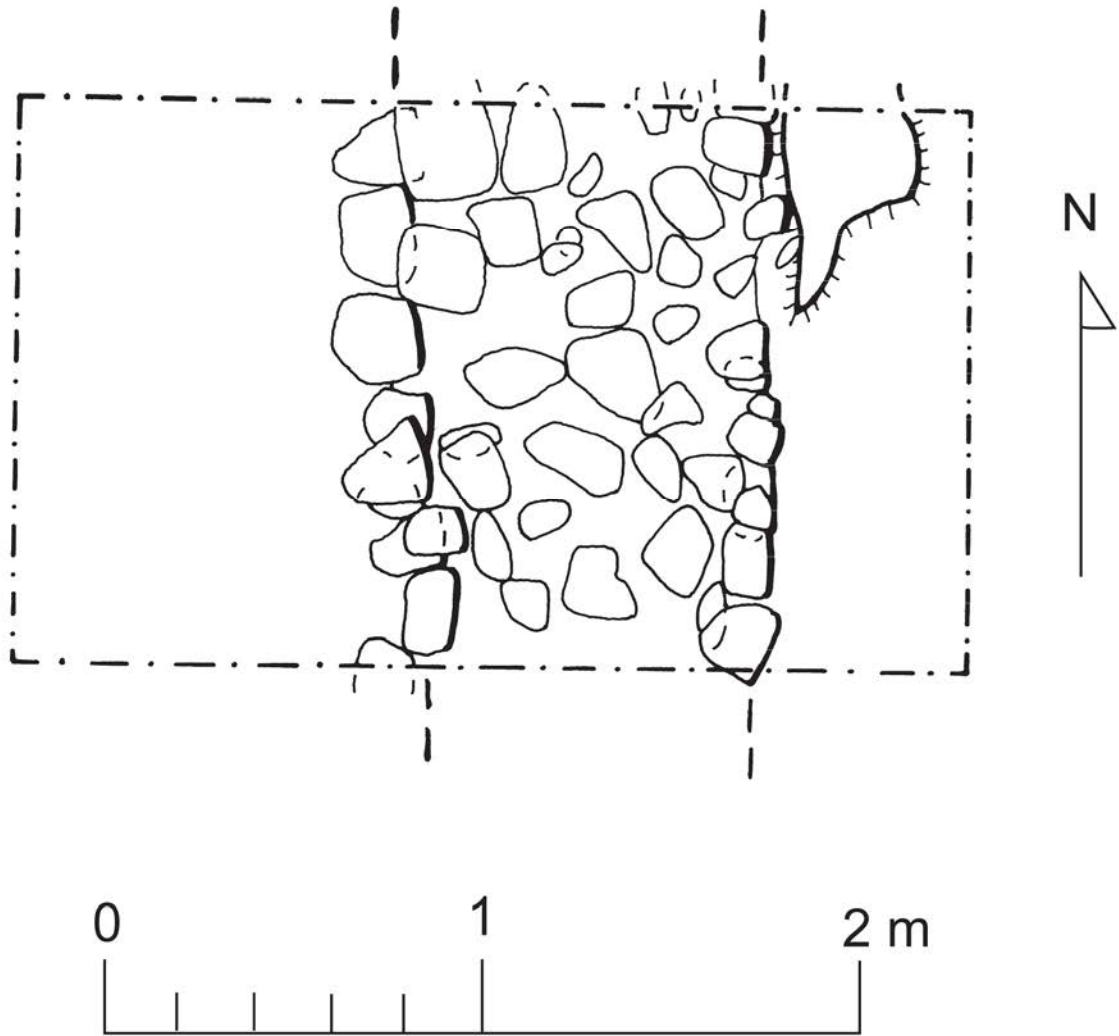

Figure 9: Plan of Op C174E (after A. Chase and D. Chase 2006)

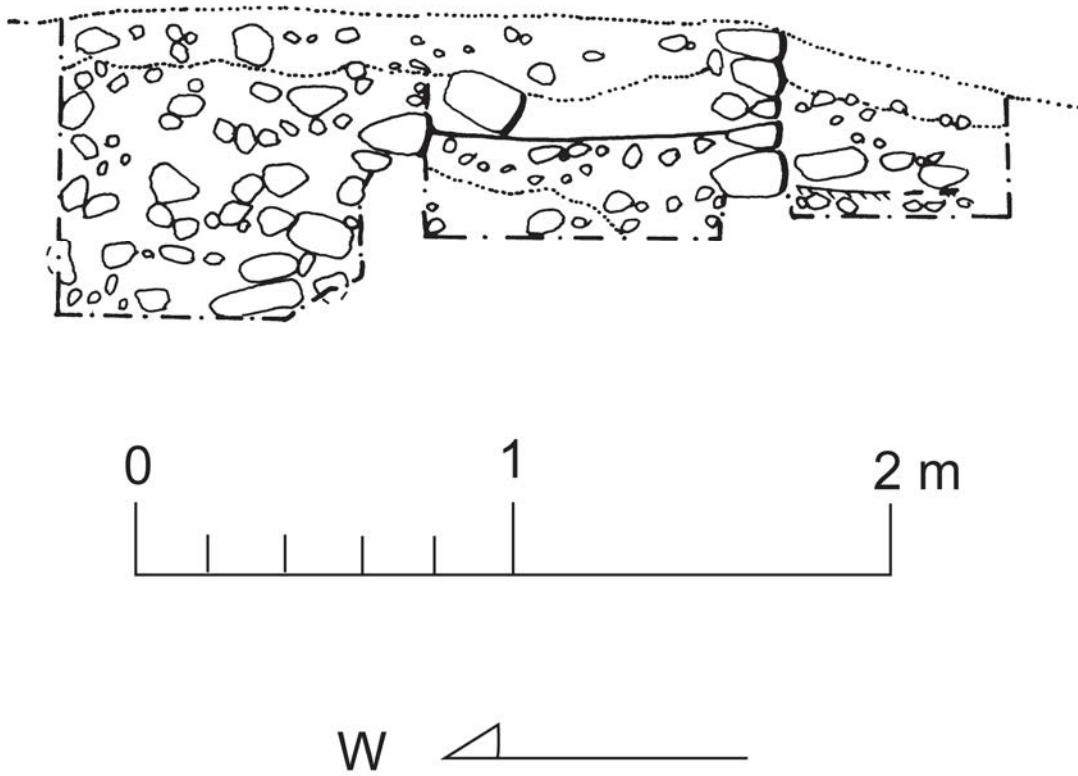

Figure 10: Section of Op C174E (after A. Chase and D. Chase 2006)

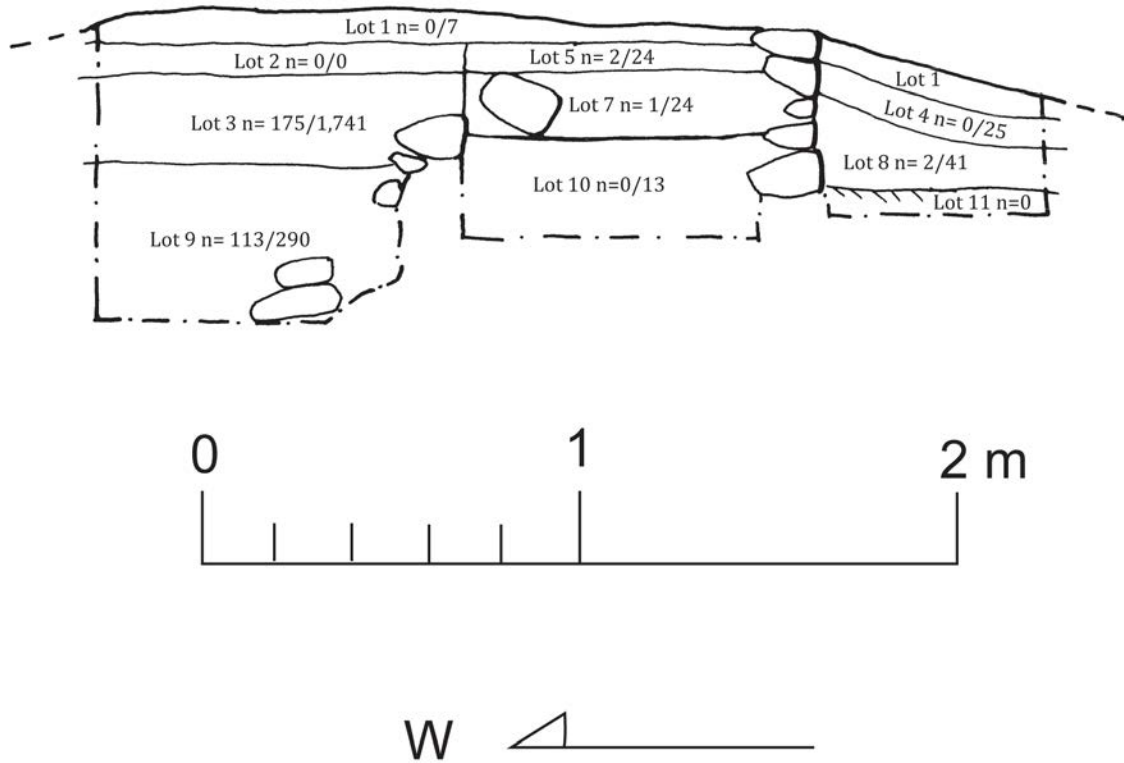

Figure 11: Lot Diagram of Op C174E Showing Excavation Subdivisions and Sampled Chert Lithic Material out of Total Amount Recovered. (after A. Chase and D. Chase 2006)

Although initial testing at this group was carried out to understand the nature of western buildings in the Terminal Classic in terms of burial practices, as reflected at other Maya sites in the Petén (A. Chase 2004), no burial was found on axis to the western building. Unexpectedly found; however, were large quantities of chert lithic material. A. Chase and D. Chase (2006: 18) state,

“What is interesting is the large quantity of chert debitage that was recovered from Structure B143 [Suboperation C174E] and the chultun excavation. The inhabitants of this group were clearly manufacturing items in or near this locus, using chert tools...during the later part of the Late Classic or during the Terminal Classic Period.”

In addition to the two western excavations, an axial trench was placed over the southern building and a small test unit was positioned over the eastern building to understand construction phases. At least two constructions were evident in all excavations. These excavations (C174B and C174D), yielded burial and stratigraphic data consistent with the Terminal Classic Period (see A. Chase and D. Chase 2006 for complete description of excavations).

The Gateway Group produced data indicative of a craft workshop or craft production area. Excavations at this group produced 3,128 pieces of chert material weighing 11,200.1 grams. A percentage of the assemblage will be described in detail below. Arlen Chase and Diane Chase (2006:15) assert that “...fill materials were recovered that indicated that chert production had taken place nearby... [And] these data indicate that the Gateway Group was probably involved in epicentral workshop activities...” Additionally, a worked deer antler tine or billet (see A. Chase and D. Chase 2006 Figure 45a) was also recovered from the chultun context. Again, the Chases (2006: 16) claim that “the quantity of chert (in conjunction with the

antler tine) indicates that this material was being worked nearby and then perhaps purposefully redeposited in or near the chultun.”

The quantity of chert recovered at this locus demonstrates an abnormal and substantial amount relative to other groups at the site. Similar contexts have been found within in the boundaries of Caracol (Pope 1994, Pope Jones 1996, A. Chase and D. Chase 2000) and at other Maya sites (Puleston 1969, Aoyama 2007, Shafer and Hester1983), where they are interpreted to be crafting areas. Costin (2001:291) states, “...when large quantities of some items are used, it is assumed that they must have been produced by specialists, often specifically in large workshops, because it is assumed that *only* workshop-based specialists make large numbers of objects.” This amount of material is too high for use by a single unit (family or other) at this location (Santley and Kneebone 1993). Thus, a production locus can be defined by the lithic assemblage alone if nothing else remains.

Problems in Analyzing the Gateway Group

It is important to note that the absence of crafting debitage and the nature of secondary deposits in the Maya area present potential problems from the onset of this analysis. Even though secondary refuse deposits are problematic when encountered archaeologically, much research has focused on the aggregate analysis of secondary deposits, while attempting to understand formation processes and ancient behavioral activities that create secondary refuse deposits (see Hayden and Canon 1983, Wilson 1994, Tani 1995). In this thesis there is 1) no craft production debris present with which to correlate the lithic materials and 2) the artifacts were recovered from a secondary fill layer between construction phases in one building and from within an adjacent chultun. For other residential groups, Pope (1994) argues for a craft

production area at Caracol on the basis of not only the lithic assemblage, but also shell debris that was discarded during the craft production process (as these materials co-occurred). The Gateway Group has no such craft production debris, signifying that the craft produced here may have been perishable in the archaeological record; the logical crafted material would have been wood. Secondary deposits continue to plague Mesoamerican archaeologists as most of the evidence for craft production occurs in building construction fill (see Moholy-Nagy 1997 for discussion). Let us highlight these issues further.

Although wood is perishable at most Maya sites, we know that it is an important medium for crafting. For example, wood artifacts have been found at Olmec sites in Veracruz ([Figure 12](#)) (Diehl 2004:45, Ekholm 1964), Aztec sites in Central Mexico (Saville 1925), and Maya sites like Dzibilchaltun, in Yucatan, Mexico (Taschek 1994: 175-178) and Tikal in Guatemala (Becker 1973, Grube 2000: 117, 168, 182- 183). Wood was probably a preferred medium for some musical instruments (Saville 1925, Hammond 1972), ritual and warfare paraphernalia (Saville 1925), and domestic items.



Figure 12: Wooden Olmec Figure (after Ekholm 1964: 6)

Moreover, wood could have been carved, scrapped, chiseled, incised, and drilled to create crafts for any aspect of ancient Mesoamerican society, including: arrow shafts, knife handles, shuttles for weaving, ear spools, musical instruments, warfare paraphernalia (atlatl, arrows, knife handles, shields, clubs), stamps, masks, canoe paddles, vessels of multiple forms and functions, figurines, spindle whorls, cradle boards, stools or seats, ornamental objects, decorative architectural objects, and even large decorated back racks used by the elite. Realistically, wooden crafts in ancient Mesoamerica are not given enough attention in the literature, meaning that scholars are unsure of their exact value or function in ancient Maya society. To understand the full range of wooden crafts at any Mesoamerican site would introduce such a range of materials as to perplex scales of craft production. If we consider the above examples in comparison to other craft materials, wood could have been used in nearly all elite/ non-elite and domestic/ ritual arenas.

It is also conceivable that no craft was produced here in its entirety, but was rather only modified. Nearly completed crafts could have been finished by lightly or deeply incising either wood, ceramic, bone, or shell. Although possible, I would argue that some craft debris should have entered the trash along with the tools themselves.

In contrast to primary deposits, secondary deposits are more commonly excavated and therefore form the basis of how most Maya archaeologists interpret ancient stone tool technology regarding specialized production behavior (Pope Jones 1996, Puleston 1969, Moholy-Nagy 1997, Shafer and Hester 1983, Fedick 1991, Mitchum 1991, Clark and Bryant 1991). Archaeologists recognize that interpretation is subject to our understanding of formation processes (Schiffer 1972, Tani 1995), as well as modes of production and modes of waste disposal in the archaeological record (Santley and Kneebone 1993). A common

misunderstanding is that a “workshop dump” is analogous to “workshop” (Moholy-Nagy 1990: 268). Scholars have assumed that the locations of large chert refuse deposits are primary indicators of production loci (Shafer and Hester 1983). This is not often the case however, as the workshop dumps may refer to open areas away from the area of actual reduction sequences and, these dumps may also build up over time.

I argue that a different kind of secondary deposit – one from within construction fill at a residential group – if excavated correctly, can be used to define evidence for a craft production locus. Inferring a craft production locus at Caracol, Belize is usually based on the co-occurrence of both lithic and craft debitage (Pope 1994, Pope Jones 1996). There is a possibility; however, that data recovered from secondary deposits within construction layers may have been transported from elsewhere, possibly multiple times; therefore, archaeologists cannot debate the merit in assessing any true meaning regarding production without first considering a number of factors. Workshop dumps are indicators of discard behavior, not necessarily the production process (Moholy-Nagy 1990:269). If we consider a range factors; however, it should be possible to use particular secondary deposits as primary indicators of production.

Moholy-Nagy (1990: 270-272) describes six general archaeological contexts in which lithic debris can occur: 1) debitage mounds; 2) other unincorporated debitage concentrations; 3) microdebitage incorporated into floors; 4) debitage incorporated into construction fills; 5) debitage included in special deposits; and 6) random scatter. The second, third, and fourth contexts are of particular importance in this thesis as they aid in the recognition of a primary workshop or craft production locus using discard behavior.

All materials in the current study come from two contexts: a chultun and a sealed deposit between Early to Middle Classic and Late to Terminal Classic construction layers. The first

context yielded at least 898 chert artifacts and one used deer antler billet (see A. Chase and D. Chase 2006 figure 45a), while the second yielded at least 2,156 chert artifacts (see above). All artifacts are cross-dated against ceramics to the Late to Terminal Classic Period (A. Chase and D. Chase 2006). It is important to keep in mind that out of all the excavations at this locus, these two contexts produced the most lithic material *and* are adjacent to one another.

We can prove quite easily that the secondary nature of the construction fill layer is indeed an indication of a primary production locus. Moholy-Nagy (1990: 271) states that,

“...at many sites sufficient earthen fill for construction of all kinds could not be obtained in the immediate vicinity, and it was a common practice to incorporate domestic and industrial middens. At large sites with long occupations, most of the durable material-culture inventory is, in fact, recovered from the fill of buildings and other features.”

In this case, the trenched building (Structure B143) was not a large temple that needed tons of earth or “durable material-culture” to constitute it, but simply a platform that during modification reincorporated production wastes from the group’s activities. This was apparent by the careful excavation of the recovered material. Each lot was screened and therefore all lithic artifacts were recovered. The same methodology was used for the chultun excavation. The full complement of lithic reduction was present in the catalogue (e.g., primary cortical flakes, secondary, and tertiary thinning flakes). The excavation methodology is vital in recognizing the magnitude and potential of construction fills (Moholy-Nagy 1990).

Similarly, Moholy-Nagy (1990: 271) stresses that “ethnoarchaeological observations have shown that microdebitage is usually not removed from its locus of production and remains in primary contexts.” Soil samples were taken from contexts at other groups at Caracol that were defined as craft production loci and have yielded microdebitage (Chase and Chase personal

communication 2007). Although no samples were processed from the Gateway Group, it is highly likely that, if sampled, microdebitage would be present for the current study, as some amount of microdebitage was probably moved. Thus, it is understood that this area, both the chultun and construction fill layers, are indeed indicators of where chert tools were made, used to create crafts (of wood or some other perishable material), and were later deposited in architectural fill within the same group, as the ancient Maya maintained their house groups through time and space. Since these materials have traveled together during their respective use life trajectories, it is safe to assume that other observations can be tested to validate a secondary deposit as indicating a primary craft production area. For example, in dealing with secondary obsidian deposits, Torrence (1986) pursues lines of evidence to illuminate levels of craft production. Torrence (1986: 147) asserts,

“In order to distinguish between various types of labor force, alternative properties, such as efficiency and standardization, which are connected with the nature of production must be examined... In particular, standardization in the dimensions of the debitage and finished tools, use of techniques to minimize the amount of time and raw material used, and the incident of errors have been found to be appropriate measures of commercial production.”

He is essentially outlining other methods by which secondary deposits of lithic debitage and tools can be assessed to prove a particular level of craft production. He goes on to state (1986: 147), “...standardization of outputs and not simply quantity of labor will be more powerful factors for reconstructing the economic milieu in which...artifacts are generated.” Costin (1991:32), in support, asserts that “indirect data are recorded from the finished artifacts themselves...These include the recognition of large numbers of more or less identical or standardized items.” Thus, if archaeologists can prove that an assemblage is both distinct in terms of quantity of tools and debitage, while at the same time quantifiably proving that there is

standardization among the assemblage, then it can be interpreted that an area does indeed have evidence of crafting or specialized manufacture.

In conclusion, waste disposal in Mesoamerica is dependent on the scale, intensity, and location at which craft producers produce. Testing for standardization can only validate archaeological observations. Culture affects the way crafters relocate or dispose of trash as they maintain their “workshops.” This creates a dilemma for archaeologists as they test for craft production areas; however, if we consider the range of possible waste management modes and follow strict excavation methods, while assessing aspects like standardization, it is possible to recognize and collect data that elucidates craft production areas, even if these locations are secondary contexts.

Lithic Materials

During the 2007 field season, I made a cursory assessment of the Gateway Group lithic assemblage as a whole and, after discussions with Drs. Arlen and Diane Chase, it was deemed appropriate to gain a better understanding of certain tools that seemed to be in abundance in this residential group relative to other contexts at the site. A pattern in the general morphology of tool types was apparent. Initial observations of the entire assemblage indicated that a complete reduction sequence of lithic material was present, suggesting that people at this locus not only used small chert tools but also produced them. Both cortical flakes and thinning flakes were present. The implications of this type of research were immediately obvious to the project members and directors, as craft production areas are not commonly excavated and assessed for standardization in the Maya area.

I non-randomly sampled 400 chert artifacts, weighing 1,134.4 grams, out of 3,128 total chert artifacts, weighing a total of 11,200.1 grams, excavated at the group and then exported this sample to the Archaeology Laboratory at University of Central Florida for analysis. The exported sample includes chert lithic material from Suboperations C174C, C174D, and C174E ([Table 2](#)). One chert core weighing 133.8 grams from Suboperation C5F was selected as a representative single example from the site, but is not of primary concern in this thesis research (see [Figure 4a](#)).

Context	Excavation Dimensions	Object	Total for Excavation	Sampled from Excavation
			n =	n =
C174B (Structure B140)	2.0 m N/S x 1.5 m E/W	n/a (no lithic material)	-	-
C174C/2/6/7/8 /10/11/12/ 14/15/16/ 20/21/22/23* (Chultun)	2.0 m N/S x 1.5 m E/W	Chert Flakes	557	12
		Chert Chunks	281	0
		Chert Flake Tools**	60	60
		Total	898	72
		Total Weight	5,462.7g	339.8g
C174D/1*** (Structure B142)	6.92 m N/S x 1.5 m E/W	Chert Flakes	71	0
		Partial Chert Biface	1	1
		Chert Flake Tools**	2	2
		Total	74	3
		Total Weight	1,839.7g	72.0g
C174E/3/5/7/8/9* (Structure B143)	1.5 m N/S x 2.5 m E/W	Chert Chunks	295	0
		Chert Flakes	1,639	105
		Chert Flake Tools**	219	219
		Total	2,156	324
		Total Weight	3,897.7g	588.8g
Total			3,128	399
Total Weight			11,200.1g	1,000.6g

Note: * Indicates only sampled lots, not entire excavation. Refer to Lot Diagrams for approximate locations of lots within the excavations.

** Includes all flakes tools. Not all are included in the below analysis.

*** Excluded from analyzed sample as no relevant tool types are present.

Table 2: Shows Sampling Strategy and Context, Kind of Recovered Chert Lithic Materials, and amount sampled. Notice that no lithic materials were excavated from the eastern excavation and only 74 chert artifacts came from the southern excavation. The western (Structure B143 and Chultun) excavations yielded the most amount of lithic material at the group.

Although the lithic debitage needs further analysis, it is apparent that all sampled flake tools under analysis in this thesis were created by the knapper striking either a unidirectional or multidirectional core (see Aldenderfer 1991:125) to create a blade-like flake. Flakes of this type typically have a trapezoidal cross section, two or three dorsal arrises (either converging or parallel), a moderately flat and uniform ventral surface, and a relatively common thickness of the striking platform (avg. = 3.43 mm) (Andrefsky 2006). Similar flake tools found at other locals within Caracol have similar manufacturing procedures ([Figure 13](#)). For example, Pope Jones (1996: 103) states:

“The drills from Caracol are usually made from modified tertiary flakes, which are further reduced by trimming along the lateral edges. During the manufacturing of the drills, a ridge is formed by rotating a core creating more than one platform, thus forming an ‘amorphous’ shaped core. A flake is then removed by a blow to a core platform, causing the ridge to be found on the dorsal side of the tertiary flake (i.e. ridge blade). Tiny flakes are then removed [usually dorsally] from each of the lateral edges parallel. Usually, the flake was trimmed by being struck from the ventral side removing small flakes along the lateral edge. This technique left small flake scars on the dorsal side along the lateral edges.”

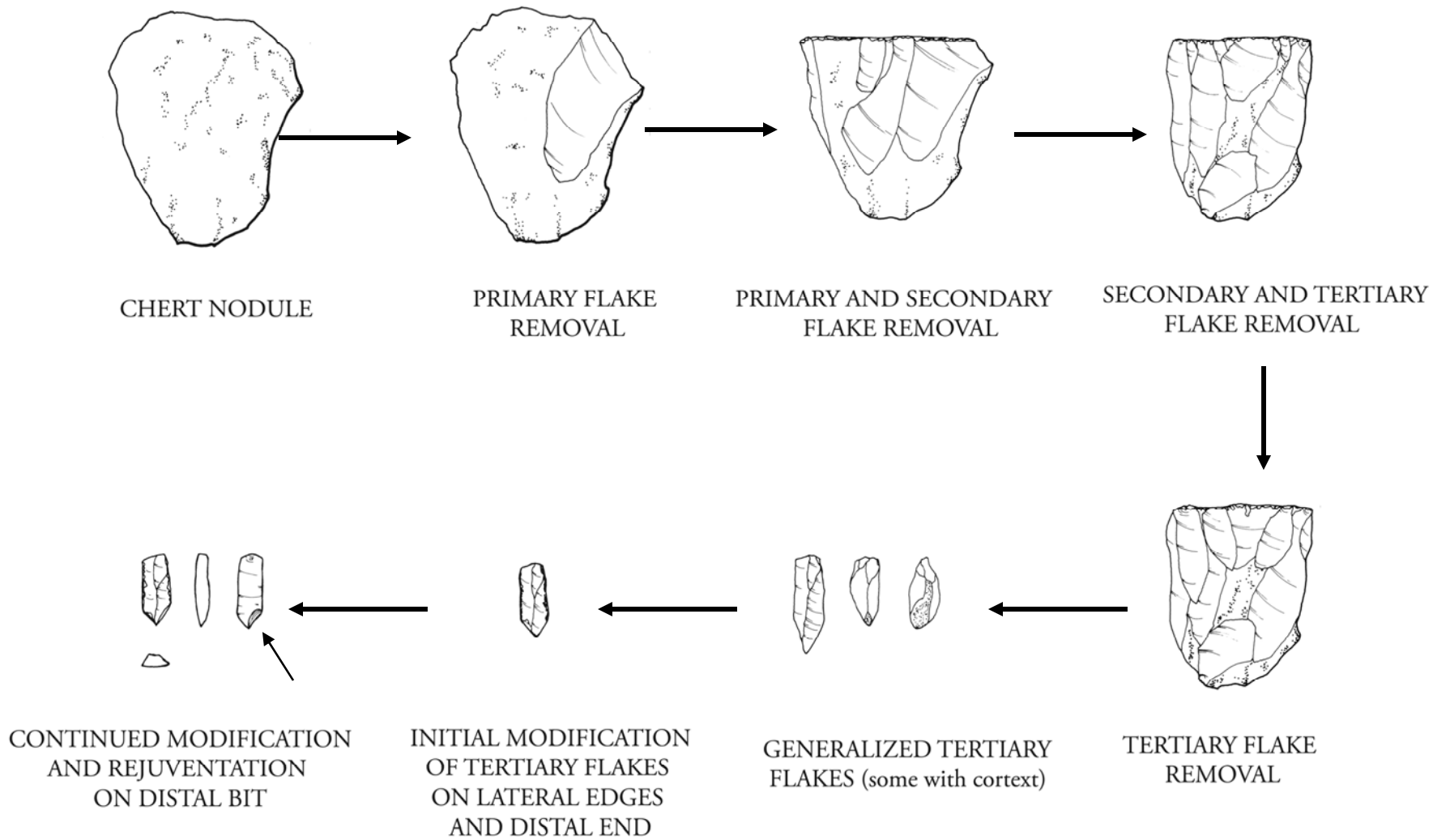

Figure 13: Idealized Reduction Sequence. At the last stage of reduction the bulb of percussion and platform are still present.

The ventral and dorsal retouch features are good indicators of function and, therefore, will receive attention later. Flake tools, as described above, also come from other cultural contexts and probably functioned within similar economic units. Tools of this type have been recovered and described from Maya sites that include Uxacatun (Kidder 1947), Tikal (Moholy-Nagy 2003: Figures 55-56), El Mirador (Hansen 1990: 279), and Becan (Stoltman 1978: 14, Figure 2). Tools of this sort have also been described by Ford (1955: 134) as scrapers and drills worked at the Jaketown site in Mississippi. The need for ancient cultures, regardless of complexity or scale, to drill, scrape, puncture, and incise is presumably typical of all societies.

Other flake tools recovered from the above contexts are simple flake tools that have been utilized marginally along one or two lateral sides (see [Appendix F](#)). These flakes are typical products from cortex removal and general biface thinning and do not relate to the specific research questions regarding tool standardization. These tools would have been made to function within this particular workshop area.

Methods of Analysis: Qualitative and Quantitative

Lithic analysis in the Maya area employs a range of methods (see Chapter Two). Early and current research relies on overall tool morphology to define specific typologies, while not mentioning function specifically (Kidder 1947, Kaneko 2003). Other researchers justify interpretation of tool function using microwear analysis (Aldenderfer et al. 1989, Aldenderfer 1991, Aoyama 2007). This technique also uses tool typologies and is becoming the norm as more and more lithicists are actively and carefully removing and processing the data themselves. Experimental studies have obviously contributed to the development of this research as comparative databases are created (Lewenstein 1991a, 1991b, 1987, Titmus and Clark 2003,

Hirth et al. 2003). One dilemma lithic analysts face is the time and resources it takes to process samples and access comparative materials. Microwear analysis needs laboratory space and a comparative database. Morphological studies are sometime dependent on previous research for analysis or methodology and might be misleading if there are inconsistencies in description.

In the Maya area, no body of research exists which deals with specific tool types in terms of both standardization studies and implementation of strict statistical testing. This is surprising, considering that standardization is a key element in understanding craft production systems and social complexity (Costin 2001, Eerkens and Bettinger 2001, Roux 2003, Schortman and Urban 2004, Vaughn 2006, Sinopoli 1988, Levine 2003). The chert tools recovered from excavations at Caracol, Belize, might represent the largest known sample of particular types of small chert tools recovered from *isolated* craft production areas to date and are therefore ideal in assessing standardization of craft production materials. Costin (1991: 1) asserts isolated or “spatially restricted data sets are more likely to contain data representing a complete distribution system.” It is obvious; therefore, that multiple, contemporaneous, and isolated data sets from the same site that include possibly thousands of similar tools types are the best case scenario for studying a production and distributional system. Thus, this research is merely one component in the overall picture of Late Classic economic patterns at Caracol.

In order to study standardization among certain tool types, the morphological analysis key (see [Appendix G](#) and [H](#)) used in this thesis was adapted from other keys and designed to assess particular tool types from one locus ([Appendix A- F](#)). Having mentioned this, I caution other researchers that the application of this analysis may not be effective beyond the flake tools presented here. However, the goal is to create a standard into which certain tool types can be fit and then assessed. The ability to cross-reference these types throughout the Maya area might

highlight pan-Mesoamerican craft industries and track the exchange of items and ideas. One major goal of the research is to give other scholars the ability to evaluate their datasets using this analysis key (qualitative) and the defined statistical tests (quantitative). Let us now take each one in turn.

This research uses a slightly different approach in order to address questions of standardization and variability in tool morphology. Only macro-level analysis (10x) was performed on the lithic material. Macro-level analysis is effective enough to determine the presence or absence of wear and degree of retouch, but it does not illuminate the directionality of wear patterns. Directionality of wear is, of course, important for understanding tool function. Microwear analysis is the best way to assess wear patterns; however, no microwear analysis was performed on the chert materials, as neither the resources nor the time was available. Microwear analyses are also not necessarily helpful in understanding tool morphological standards. However, it is hoped that future studies of all the Caracol chert subassemblages will include microwear analysis to aid in answering other questions. To be sure, the juxtaposition of tool standardization with definitive evidence of use wear patterns would be intriguing.

Both qualitative and quantitative methods were used in this thesis. Qualitative analysis was performed in order to accurately record specific morphological characteristics on each tool (e.g., length, width, thickness, presence or absence of rejuvenation flaking on each of the distal lateral edges, edge angle, etc.); (see [Appendix G](#)). Each artifact was analyzed using the analysis key and given the appropriate code. These codes were then entered into Microsoft Access in order to organize and sort the data. After this, queries were performed and exported to Microsoft Excel to create graphics which showed associations and comparisons among the data. Morphological characteristics will be discussed in detail in Chapter Four. Definitions and

validity of use in the Analysis Key is given in [Appendix G](#). Statistical analysis was also performed on the coded data.

Qualitative analyses are vital in understanding standardization among an assemblage (Levine 2003, Roux 2003, Eerkens and Bettinger 2001) in that social scientists have “come inevitably to depend more and more on quantitative data and on quantitative tests of qualitatively described relations” (Bernard 2002:24). Testing standardization is of concern here as it is a vital element in describing and understanding ancient forms of economic organization in terms of craft specialization (Costin 2001: 301-303).

Artifact Plan Form or “Tool Type” (used from here on) was tested for occurrences of certain features in order to better understand associations between artifact type and specific morphological characteristics ([Figure 14](#)). Particular characteristics include, for example, the presence or absence of rejuvenation flakes on the distal end of the tool relative to tool type (see [Figure 15](#)). These associations and their probabilities are given in Chapter Four (see [Table 4](#)). The implications of these data are that, if a certain tool type has a particular feature repeatedly, this reflects an idealized form or indication of a certain technologically important feature that makes the tool more effective at working crafts. This repetition is a standardized or simple repetitive mechanical activity recorded on the tool itself. Unlike ceramic vessel manufacture, which etically differentiates between intentional and mechanical or unintentional attribute analyses (Costin and Hagstrum 1995), the mechanical technique used in the production or use of a stone tool is always intentional. Use-wear and rejuvenation flaking are caused by emic behavior and intentional use of the tool. Therefore, recording and comparing mechanical attributes is justifiable. Costin and Hagstrum (1999: 622) state: “The artisan consciously controls intentional attributes. These include technological, morphological, and stylistic

properties that broadly reflect [vessel] function whether economic, social, or political.” Chapter Four discusses distal rejuvenation flaking and its purposefulness as expressed through the *Chi-square* statistic.

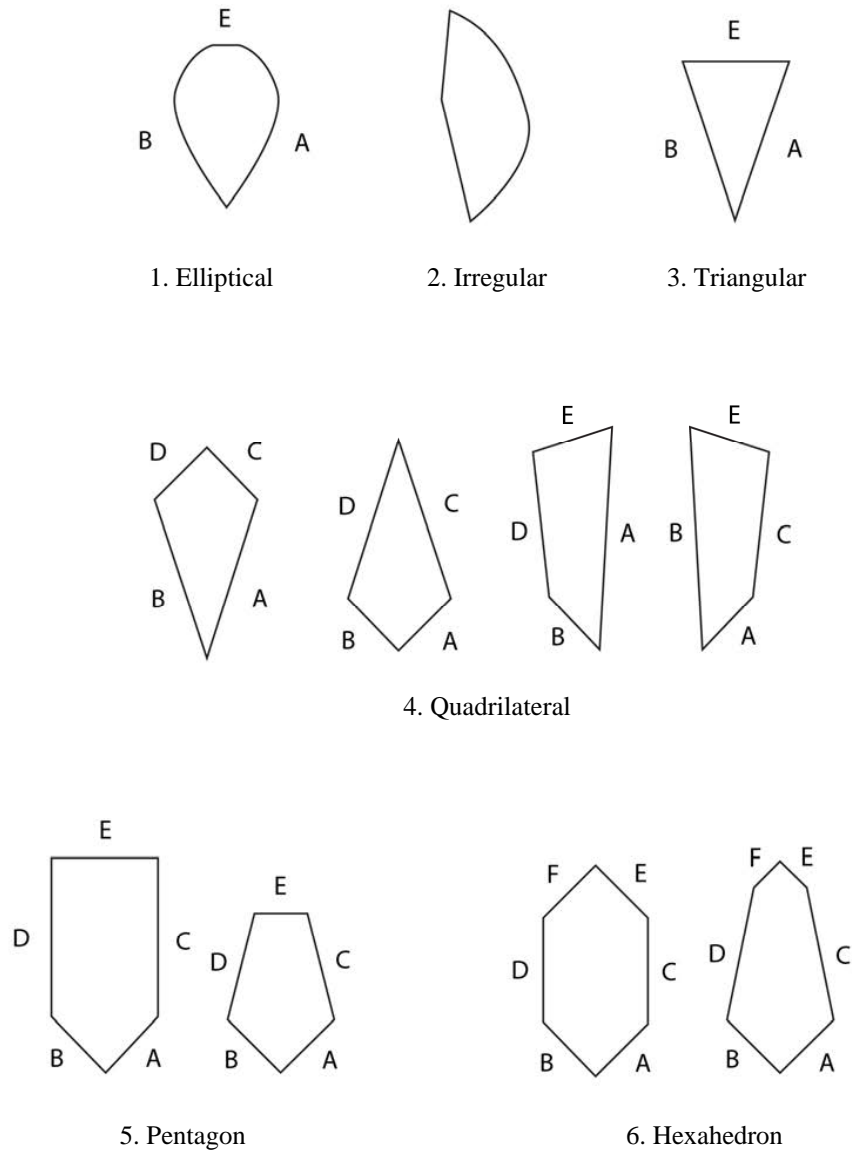

Figure 14: Showing Tool Types based on Plan Form or the number of sides present on each flake tool. Tool Types maybe be indicative of a kinds of flakes removed from a core or steps in the reduction sequence of a flake.

Chi-squared tests “provide significant evidence of an association between two variables” (Fletcher and Lock 2005) and is designed to test the null hypothesis. For this thesis a 2 x 2 Chi-Square chart was created as is illustrated below in [Table 3](#).

Table 3: Hypothetical 2x2 Chi-Square Chart with Observed Frequencies.

Artifact feature	Absence (-)	Presence (+)	Totals
X	Observed (a)	Observed (b)	Observed Totals
X	Observed (c)	Observed (d)	Observed Totals
Totals	Observed Totals	Observed Totals	Observed Totals

Chi-square formula*
$$X^2 = \frac{n(ad - bc)}{(a + b)(c + d)(a + c)(b + d)}$$

*formula taken from Spaulding 1953:47

Tool Type standardization also was tested using Coefficient of Variation or *CV*. The *CV* statistical method has a more complex purpose and is applicable for different types of data while intending to normalize or standardize populations of data, measuring variability around a mean. Eerkins and Bettinger (2001: 494) argue that *CV* is a “stable and reliable...statistical method form comparing variation between assemblages that is applicable to cases where assemblages differ with respect to artifact class of attribute size.” Roux (2003: 768), while also advocating the use of *CV*, states that “degree of standardization may be assessed through raw material composition, manufacturing techniques, form and dimensions, and surface decoration.” In short, this statistical method can be used on any artifact class insofar as there are comparisons being made. Specifically, comparing *CV* will demonstrate standardization. Other statistical data are given along with *CV* results as to verify associations (see below).

Unlike Chi-square, which measures associations of artifact features, *CV* tests or measures some degree of standardization in products produced by human hands and therefore has important implications for understanding ancient organization and production systems (Costin 2001) and might even hint at the exchange of ideas. Costin (2001:301) asserts that “standardization is used as a proxy for the relative number of artisans.” She cautions, however, that, standardization as a unit of measure “is most useful when comparing two or more analytical units...and degree of standardization is often subjective” (2001:302). On the other hand, Costin makes no mention of statistical methods and their reliability or use. Statistical tests can calculate the standardized nature of mechanical attributes in terms of craft production. They can assess the morphological attributes caused by tools or the products found within a crafting locus. “Mechanical attributes...relate to motor habits and skill...” and therefore “more directly reflect the organization of production” (Roux 2003:768). Variation within the motor habits of different individuals produces differences on the product (i.e. both the tool and craft). Eerkins and Bettinger (2001:493) summarize this principle succinctly,

“Variation is useful for understanding such a broad range of phenomena because it reflects the degree of tolerance for deviation from a standardized size, shape, form, or method of construction. Higher tolerances increase variability, while lower tolerances decreases variability leading to standardization. Standardization, then, is a relative measure of the degree to which artifacts are made to be the same. Standardization is in turn related to the life cycle of the artifact type or class in question, reflecting such things as production costs, consumer preferences, replication and learning behaviors, number of producers, concern with quality, producer skill, and access to resources.”

CV is simply defined as the artifact sample standard deviation (*SD*) divided by the artifact sample mean (\bar{x}) (this total is sometimes multiplied by 100 and therefore is expressed as a percent). The *CV* normalizes measurements and places them on a fixed scale from 0 to 1 in that

a number tending towards 0 has greater standardization or less variation and a number tending towards 1 has less standardization or greater variation. Typical ceramic *CV* percents are lower than lithic *CVs* (< 17%) given the flexibility in recovering or fixing errors during the manufacturing process (see Eerkins and Bettinger 2001: 499 Table 1, Longacre et al. 1988, Roux 2003 Tables 1-3). Ceramic manufacture is additive not subtractive. A single ground stone study determines standardization is present when *CV* percents are between 11-34, depending on the recorded attribute (VanPool and Leonard 2002: 722 Tables 2-3). Flake-stone manufacture is obviously less exact, but similar to ground stone given the method of manufacture and the heterogeneity of some chert material. Although no *CV* tests have been computed for craft production tools in the Maya area, most data indicates standardization is present if the *CV* is between 6-36 (see Eerkins and Bettinger 2001 and data in this thesis). To be sure, variability in ranges of standardization is dependent on cultural context as well as diachronic versus synchronic data.

The Coefficient of Variation is computed using the following formula:

$$V = SD / x$$

Where *V* is the *Coefficient of Variation*, *SD* is the *Standard Deviation*, and *x* is the *mean* of the sample, then *V* x 100 to express as a %

Chapter Four will calculate the degree of standardization of flake tool dimensions in terms of specific morphological features using *CV*. The use of *CV* is also valid in estimating which tool types, separated by number of sides or *plan form* (see [Appendix H](#)), have a higher degree of standardization or lower *CV* when expressed as a percent.

Issues in using *CV* to these tool types include the lack of comparable data sets; therefore, other statistical methods have been implemented to support *CV* interpretations, like confidence scoring and determining the ideal tool type based on 1 *SD* from the mean of particular measurable features in separate tool types. In other words, what percent of tools fall within a single *SD*? Additionally, ideal tool types that are within 1 *SD* from the mean are assessed to determine an ideal and intentional ratio created between corresponding sides (e.g., Side B to Side D). An intentional or desirable ratio between corresponding sides is functionally significant, in that it reflects purposefully created multifunctional edges along a single side of a stone tool.

Following the assessment of the data in [Appendix I](#), an effort is made to include other data from craft production areas at Caracol (Pope Jones 1996). Pope Jones (1996:133, 117, 120, and 125) provides statistical data that can be plugged into the *CV* statistic. This might be problematic however, as earlier research may not have taken into account specific features on the artifacts that have been considered here; therefore, *CV* is used only to compare overall length, width, and thickness of flake tools (i.e. drills). It is expected that similar workshop areas will have similar *CVs*, as they may have used tools similarly.

Preliminary interpretations will be given in terms of degree of observable standardization in alternative workshop contexts. For example, do separate workshops that produce the same craft have similar *CV* percents? If so, can we demonstrate the ideal tool type for those production loci? The determination of an ideal tool type may elucidate the types of crafts being created and therefore justify comparisons between craft production loci. More data is need from these artifacts to make definitive conclusions. Although there may be issues in comparisons between data sets, it is hoped that future studies will reanalyze other assemblages using the current analysis methodology and generate more definitive comparisons that will guide future

research directions. The determination of ideal tool types with respect to craft industry is important in assessing scale of production.

Given the above, it is not surprising, then, to apply *CV* to different types of artifacts. As stated above, the majority of *CV* applications in the archaeological community applies to ceramic metric and chemical data (Arnold 1991, Blackman et al. 1993, Costin and Hagstrum 1995, D'Altroy and Bishop 1990, Kvanne et al. 1996, Longacre et al. 1988, Roux 2003) and ground stone studies (VanPool and Leonard 2002). No one has yet to apply it specifically to discussions of lithic standardization in the Maya area. Perhaps this is due in part to the lack of large available comparative data sets. It is believed that the data contained in this thesis and its comparison to similar chert tools from other craft production loci at Caracol is the first attempt at applying the *CV* statistic to a large Maya collection of similar artifacts. To date, at least 1,272 small chert tools catalogued by various names (i.e. drills, scrapers, incisors, awls, or burins) have been recovered from particularly well-defined and isolated production contexts at Caracol, Belize. Thus, a discussion of tool standardization is critically important in understanding craft production intensity and organization at any scale and is certainly a worthwhile effort given the growing attention that lithic studies are receiving. A future goal might be able to both qualify and quantify artifacts into proper types during the cataloguing process by using the methodology presented here.

CHAPTER FOUR: DATA, DISCUSSION, AND INTERPRETATION

This chapter operationalizes the statistical methods presented in Chapter 3 and incorporates other measurable, morphological observations in order to discuss the overall assemblage and its interpretive value. Interpretations that follow the data will be given in terms of particular principles of craft production that will show how small chert tools from a single locus may be used to reveal the nature of both Maya households during the Late and Terminal Classic Period and the ancient Maya economy as a whole. Specifically, data will be interpreted and tested against the hypotheses given in Chapter 1 (see Table 1).

The first test utilizes Chi-square to compare two variables: tool type and the presence or absence of a *rejuvenation flake* at the distal end of the artifact. This test queried data to include *plan form* or Tool Type and *rejuvenation* categories and included all tools with noticeable and intentional rejuvenation distally, regardless of completeness. In order to determine association between Tool Type and distal end morphology, Types 1 through 4 are combined and 5 and 6 are combined, and then compared ([Table 4](#)). The combination of tool types is based on observations of the entire tool which suggested that tool types 1-4 had alternative functions when compared to types 5 and 6. In general types 1-4 have alternative morphologies both laterally and distally. These artifacts also varied in overall size and shape. Macro-level observations of these indicate tools may have been for scrapping or piercing, primarily, and may not have had the same multifunctional use as types 5 and 6. Types 5 and 6 had near analogous morphology with the only difference being in the proximal end of the tool. This difference occurs in the initial removal of the blade flake from a core and would not have affected the distal end of the artifact which is of concern below.

Table 4: Chi-Square 2x2 Chart on all Tool Types with and without Rejuvenation and Distal End Completeness.

Type or Plan Form	(+) Rejuv.	(-) Rejuv.	Totals
1, 2, 3, and 4	12	32	44
5 and 6	149	36	185
Totals	161	68	229

$$x^2 = \frac{229[(12 \times 36) - (32 \times 149)]^2}{(12 + 32)(149 + 36)(12 + 149)(32 + 36)} \quad x^2 = 48.3, \text{ with d.f.} = 1 \text{ then } p = 0.0001$$

When the Chi-square is computed from the 2x2 chart with d.f. =1, $x^2 = 48.3$ and $P = 0.0001$, this association is statistically significant. In other words, when $P = 0.0001$, then it is highly *unlikely* that the association between Type and positive rejuvenation is due to coincidence or random sampling. The above total clearly rejects the null hypothesis that there is no association between the Type and rejuvenation presence or absence. By rejecting the null hypothesis, the test proves that when pentagonal (5) or hexahedron (6) tool types are present there is a strong likelihood that there will be a rejuvenation flake on the distal end. Rejuvenation flaking is therefore strongly dependent on Tool Type. This feature and plan form association, in terms of behavior, signifies that there was a desired tool form used for a specific, possibly standardized, function. A rejuvenation flake creates a shaper edge, which allows the craft producer to effectively cut or incise another object (a simple experimental study was done by the author on a mahogany wood board). Other tool types did not have a strong likelihood of having a rejuvenation flake on the distal end and therefore may have had a different function in antiquity. It is also likely that the presence of a rejuvenation flake reflects a last ditch effort at

using the tool before it is discarded. Be that as it may, the association between Type and rejuvenation flaking is highly significant.

Rejuvenation flaking morphology was also tested for sidedness. Simply put, as shown above, Type 5 tools have a high occurrence of rejuvenation distally, but on which side was the flaking most likely to occur? This question was asked because of observations during the detailed analysis process. During this phase of analysis, each side of every artifact was coded for *location of retouch/ utilization* based on one of the six types of retouch: 1) unimarginal dorsal; 2) unimarginal ventral; 3) bimarginal or bifacial; 4) combination (both dorsal and ventral sides were retouched but in separate locations along the same side); 5) indeterminate; and 6) absent (no retouch what so ever).

In general, most tools had at least unimarginal dorsal retouch on both lateral sides (Sides C and D) and distal end (Sides A and B), indicating that the object was shaped and used both laterally and distally to some degree. Sides A and B on the distal end of the tool however, showed ventral and bimarginal retouch consistently. The extent of the dorsal retouch was done to shape the general tool form. The ventral flaking, in contrast, was performed with the removal of one relatively large flake usually on the left side (Side B) of the tool if viewed from above with the distal end pointing down (See [Appendix H](#)). The rejuvenation flake ([Figure 15](#)) is characteristic of a single ventral flake initiated in approximately the middle of the distal side (i.e. half way between the bit and the proximal extent of Side B or A). Often the length of the side is determined by the flaking itself; however this is not the case in every tool and the length of side should not be considered the true width of the flake scar. The length of the side is not important here, just the side on which the flake occurs. Observations are recorded in [Table 5](#).

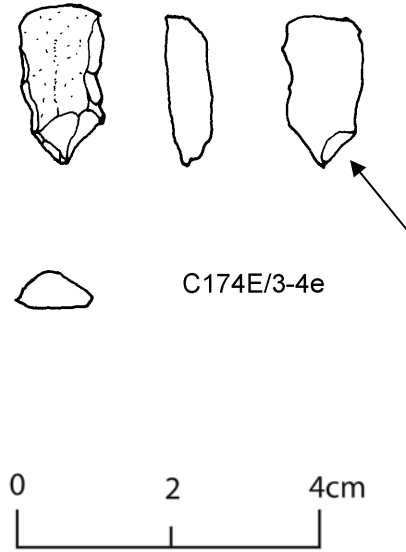

Figure 15: Type 5 Flake Tool with Side B Distal Rejuvenation Visual on Ventral Surface

Table 5: Occurrence of Rejuvenation Flakes on Type 5 Flake Tools

Number	Side A	Side B
n= 115	(-)	(+)
n= 5	(+)	(+)
n= 1	(+)	(-)
n= 0	(-)	(-)

Only Type 5 flake tools were selected for these observations and preliminary conclusions indicate that, when rejuvenation flakes are observed, they occur on Side B in 115 out of 121 artifacts. The data show that there is a standardized or selected side to be rejuvenated, indicating that there may have been a single, right-handed individual at work here or that the majority of knappers or tool users were right-handed at this locus. This has implications for how many crafts persons were at work, how they may have been organized within the house group, and if this is a proxy for part-time or full-time production. Although intriguing, this data is still preliminary and more samples are needed to fully understand this observation.

The presence or absence of rejuvenation distally is also important in separating Type 5 tools into comparable subgroups. These subgroups were tested for standardization using the CV formula presented in Chapter 3. This test asks whether or not tools with rejuvenation flakes were more or less standardized than tools without rejuvenation flakes (Table 6). All recorded data were calculated for standardization; however, Sides A-D are more relevant in terms of function and have been highlighted. Side E, can vary as it is usually the platform of the removed flake and is not important for tool function *per se*. Side E rarely received retouch during the reduction process (no retouch, n= 126 or 86.3%; unimarginal dorsal or bimarginal, n= 18 or 12.3%; indeterminate retouch, n= 2 or 1.3%).

Table 6: Summary CV Statistic Comparing Type 5 Flake Tools Separated by Distal Rejuvenation Flaking.

Variable	(+ Rejuvenation n= 121)			(- Rejuvenation n= 22)		
	Mean	SD	CV (%)	Mean	SD	CV (%)
Length (mm)	20.31	4.28	21	20.60	5.14	24
Width (mm)	9.90	1.73	17	10.14	2.14	21
Thickness (mm)	5.73	1.63	28	5.20	1.70	32
Weight (g)	1.38	0.91	65	1.15	0.67	58
Side A length (mm)	7.05	2.45	34	8.81	3.76	42
Side B length (mm)	6.88	2.56	37	8.71	4.90	56
Side C length (mm)	13.57	3.38	24	12.43	4.30	34
Side D length (mm)	13.65	3.67	26	11.76	4.14	35
Side E length (mm)	7.85	2.30	29	8.07	1.54	19

When maximum length, width, thickness of Type 5 tools with rejuvenation are compared to artifacts without rejuvenation, the data show that artifacts with rejuvenation have lower CV percents, which indicate more standardization in overall form measurements. This is expressed further by looking at the individual sides (with the exception of Side E). For example, Side A with rejuvenation has a CV of 34% compared to a CV of 42% no rejuvenation. Although Side A

supports the conclusion, Side B comparisons show Type 5 tools with rejuvenation have a *CV* of 37% versus a *CV* of 57% for Type 5 tools without rejuvenation. The distinction between sides is important as most rejuvenation occurs on Side B (see [Table 5](#)). Type 5 tools are more standardized in terms of over-all measurements and individual side measurements when subdivided by presence/ absence or rejuvenation flaking distally. We have proven the validity in these subgroups in Tables 3 and 4. In conclusion, Type 5 flake tools with rejuvenation flaking are more standardized than Type 5 flake tools without rejuvenation flaking when comparing Side A-D.

In support of these preliminary conclusions using the *CV* statistic, the data presented in [Table 6](#) did not show skewness when assessing the confidence score and shows that 72% of Type 5 artifacts (n=88) with positive rejuvenation fall within 1 *SD* of the mean when considering maximum length. This indicates that Type 5 tools with positive rejuvenation and length measurements between 16.03 and 24.59 mm represent a standard or ideal type (see [Table 12](#)).

When analyzing individual sides within the above subset of Type 5 tools, determination can be made of the ideal ratio between Sides B and D in terms of functional significance. The inclusion of Sides B and D in this assessment is due to their apparent use-related retouch (e.g., rejuvenation flaking and presence of usable edge angle measurement) and the observation that these sides were most likely used at similar times during the craft production process. If we consider and include 1 *SD* of the mean for both Sides B and D within the subset discussed above (n= 88), we see that ideal individual side measurements are between 4.31 – 9.05 mm for Side B and 10.50 – 16.18 mm for Side D; 57% (n=51) of the total 88 ideal Type 5 tools fall within these measurements. This means that just over half of the subset of Type 5 tools has a ratio of approximately 3:1 for Sides B and D respectfully. [Figure 16](#) displays the actual length

measurements of Side B as compared to Side D. This ratio is not exact due to error and unpredictability in the rejuvenation flaking; however, a 3:1 ratio is desirable due to the usability of both the distal and lateral edges. This data can therefore begin to elucidate ideal tool types and ratios of sides relative to workshop contexts. Multifunctional aspects of tools are significant when assessing how raw materials were reduced and modified. Understandably, comparative samples are vital in understanding exactly what this means for craft industries as a whole.

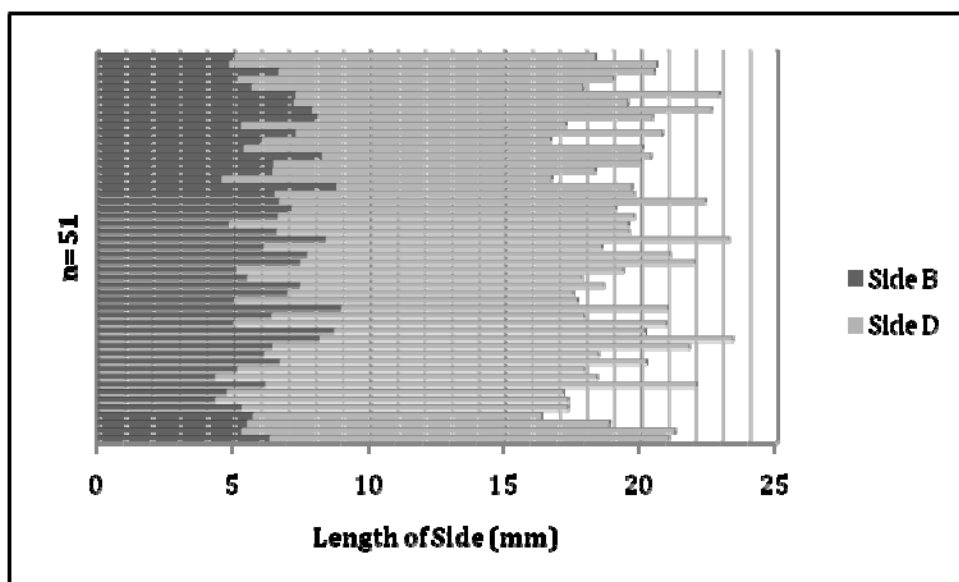

Figure 16: Shows Actual Lengths of Side B Relative to Side D. Notice the Ratio is Approximately 3:1 for Side B in relation to Side D (n= 51).

Inferring tool function can also be determined by assessing edge angle; more obtuse edge angles are more effective at scraping materials (Lewenstein 1991a, Andrefsky 2005: 160-161). It is important to note again that no micro-wear analysis have been performed on the assemblage; therefore, use wear was not observed directly. Edge angle was measured at the midpoint of the tool and, therefore, measured the edge angle of Sides C and D respectively. Edge angle was

measured on all tools, regardless of retouch type. Artifacts were sorted for presence or absence of retouch type prior to their inclusion in the assessment. [Table 7](#) describes Types 4- 6, the number of artifacts present, and the range of edge angles between 0° and 90°. A wide range of angles are present in the sample; therefore, it was necessary to measure only angles that may be indicative of a “usable” angle (see [Table 8](#)).

Table 7: Tool Type, Retouch Type, and Edge Angle between 0°- 90°

Type	Side C retouch type*	n=	° Range	Side D retouch type*	n=	° Range	Sides C and D retouch type*	n=	° Range
4	1	6	55-85	1	3	57-81	1	2	57-74
5	1	159	31-88	1	162	38-89	1	149	31-89
6	1	6	50-87	1	6	64-89	1	5	50-89

*Note:** 1= unifacial dorsal; 2= unifacial ventral; 3= bifacial; 4= combination

Table 8: Tool Type, Retouch Type, and Edge Angle between 60°- 90°

Type	Side C retouch type*	n=	° Range	Side D retouch type*	n=	° Range	Sides C and D retouch type*	n=	° Range	Mean of Angles
4	1	2	85	1	1	75	N/A	0	N/A	N/A
5	1	128	61-88	1	126	61-89	1	121	61-89	73
6	1	4	62-87	1	3	66-89	1	3	66-89	~77

*Note:** 1= unifacial dorsal; 2= unifacial ventral; 3= bifacial; 4= combination

The sample was sorted only to include angles 60°- 90° because experimental and archaeological evidence shows that edge angles between 60°- 90° tend to be used for scraping or planing (Lewenstein 1991a: 214). This observation was seen on wood-working tools and is, therefore, valid in this study for comparison. Lewenstein (1991a: 214) states that “...60 chert scraper/planes from Cerros cluster about a median of 71°.” After applying a 60°- 90° restriction, the data shows that in Type 5 tools at least 121 out of 149, or 81% of tools, have angles between 60°- 90° with a median and mean of 73° for both Sides C and D respectively ([Table 8](#)).

Therefore, the bulk of the sample may have been used for scraping or planing during the crafting process. Equally important, all the tools presented in the edge angle study have unimarginal dorsal flaking present. This type of flaking is important, as it allows for maximum scraping ability and is common on similar tools in the Maya area (see Lewenstein 1991b: 246 Table 3).

This research did not focus specifically on distal bit utilization (see Pope Jones 1996: 108-109, Puleston 1969: 49), but instead analyzed retouch on all sides. This is vital in the determination of whether or not a tool had multiple functions during the craft production process. Other research failed at determining this aspect (Pope Jones 1996) and only focused on bit utilization for tool function. It can be confidently concluded that nearly all tools (Types 4-6) collected from Structure B143 have some level of retouch on at least four sides, indicating that these tools had more than one function. A macro-level analysis reveals that bit wear is extensive. When this observation is combined with edge angle data, it strongly suggests that tools at this locus were used for drilling, incising, *and* scraping. To be sure, however, microwear analysis is needed to confirm this macro-level observation.

In addition to the above, the Coefficient of Variation statistic was used to determine standardization in all tool types present in the assemblage regardless of rejuvenation ([Tables 9-13](#)). This is necessary as tool types must have comparative value in terms of standardization; if not, CV percents are meaningless. All measurements were computed using the CV statistic. This has heuristic value because not only maximum length, width, and thickness were computed, but each side was also computed. This demonstrates that specific sub-measurements can be compared. Meaning that, if tool lengths seem to be standardized (have similar CV %), arguably tool types can be combined. That this, however, is not the case is seen in the comparison

between Sides A/ B measurements in Type 4 and Type 5 tools, which demonstrates that side standardization and function are connected. In other words, tool sides are flaked to create functional edges, thus suggesting that different tools have alternative functions based on the morphology of different sides and not on the maximum dimensions of the tool itself.

As seen in [Figures 18](#) and [19](#), tool length and width tend to be linear and cluster well; however, once the standardization is tested, it is apparent that Type 5 tools are more standardized when compared to other types (see [Figures 17- 20](#)) for scatter plots of all types). All tool types have relatively low CV percents, except for Type 4; Types 5 and 6 have the lowest percents ([Table 11](#) and [13](#)). [Table 12](#) shows CV values for Type 5 tools with rejuvenation that are 1 SD of the mean as described earlier. Types 5 and 6 could have been combined for this study, but were separated for heuristic and illustrative purposes. The only difference between Types 5 and 6 is that the length of Sides C and D are generally shorter on Type 6 due to the shape of the proximal end of the tool (see [Appendix H](#): plan form). Given the variation in stone tool production and level of acceptable errors, it is most likely the case that these tools have similar distal morphology and function. Both tool types typically also have distal rejuvenation flakes (see [Table 4](#)).

Table 9: Summary CV Statistics of Type 3 Flake Tools

Variable	n=	Mean	SD	CV	CV (%)
Length (mm)	17	24.21	8.93	.36	36
Width (mm)	17	13.38	5.48	.40	40
Thickness (mm)	17	5.85	2.15	.36	36
Weight (g)	17	2.11	2.09	.99	99
Side A length (mm)	17	23.24	8.85	.38	38
Side B length (mm)	17	23.76	7.93	.33	33
Side E length (mm)	17	11.24	5.65	.50	50

Note: Table format adapted from VanPool and Leonard (2002). Sides C and D did not appear on this artifact type sample.

Table 10: Summary CV Statistics of Type 4 Flake Tools

Variable	n=	Mean	SD	CV	CV (%)
Length (mm)	8	20.16	4.38	.21	21
Width (mm)	8	9.83	2.23	.22	22
Thickness (mm)	8	5.57	1.49	.26	26
Weight (g)	8	1.17	0.58	.49	49
Side A length (mm)	8	9.88	9.42	.95	95
Side B length (mm)	8	10.96	9.97	.90	90
Side C length (mm)	8	10.46	7.13	.68	68
Side D length (mm)	8	7.01	6.29	.89	89

Table 11: Summary CV Statistics of Type 5 Flake Tools

Variable	n=	Mean	SD	CV	CV (%)
Length (mm)	146	20.39	4.39	.21	21
Width (mm)	146	9.94	1.77	.17	17
Thickness (mm)	146	5.65	1.66	.29	29
Weight (g)	146	1.34	0.88	.65	65
Side A length (mm)	146	7.31	2.77	.37	37
Side B length (mm)	146	7.17	3.10	.43	43
Side C length (mm)	146	13.38	3.59	.26	26
Side D length (mm)	146	13.35	3.80	.28	28
Side E length (mm)	146	7.90	2.20	.27	27

Table 12: Summary CV Statistics of Type 5 Flake Tools with Distal Rejuvenation that are 1 SD of the Mean.

Variable	n=	Mean	SD	CV	CV (%)
Length (mm)	88	19.71	2.31	.11	11
Width (mm)	88	9.76	1.31	.13	13
Thickness (mm)	88	5.63	1.41	.25	25
Weight (g)	88	1.22	0.52	.42	42
Side A length (mm)	88	6.74	1.95	.28	28
Side B length (mm)	88	6.68	2.37	.35	35
Side C length (mm)	88	13.35	2.42	.18	18
Side D length (mm)	88	13.34	2.84	.21	21
Side E length (mm)	88	7.70	1.95	.25	25

Table 13: Summary CV Statistics of Type 6 Flake Tools

Variable	n=	Mean	SD	CV	CV (%)
Length (mm)	4	20.44	2.47	.12	12
Width (mm)	4	9.53	1.17	.12	12
Thickness (mm)	4	5.86	1.83	.31	31
Weight (g)	4	1.12	0.57	.50	50
Side A length (mm)	4	6.69	1.56	.23	23
Side B length (mm)	4	5.87	1.36	.23	23
Side C length (mm)	4	9.69	2.18	.22	22
Side D length (mm)	4	11.99	2.04	.17	17
Side E length (mm)	4	7.74	2.51	.32	32

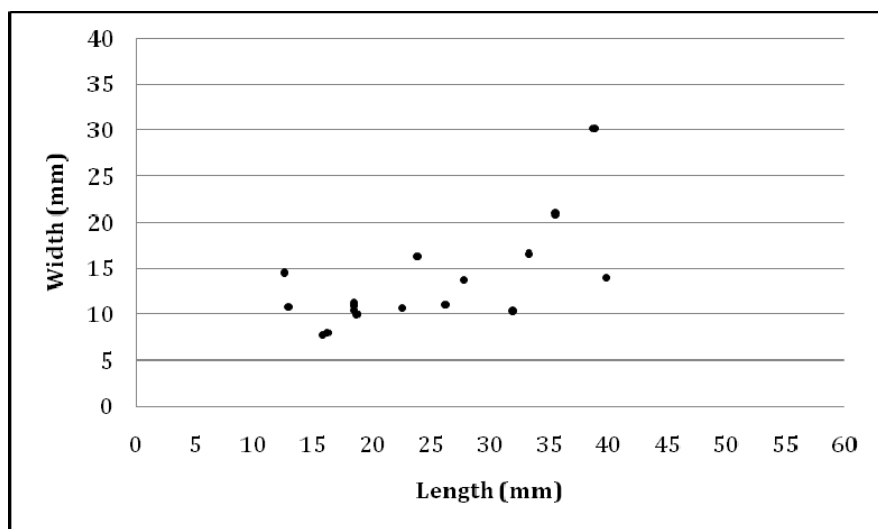

Figure 17: Scatter Plot Type 3 Flake Tools (n= 17).

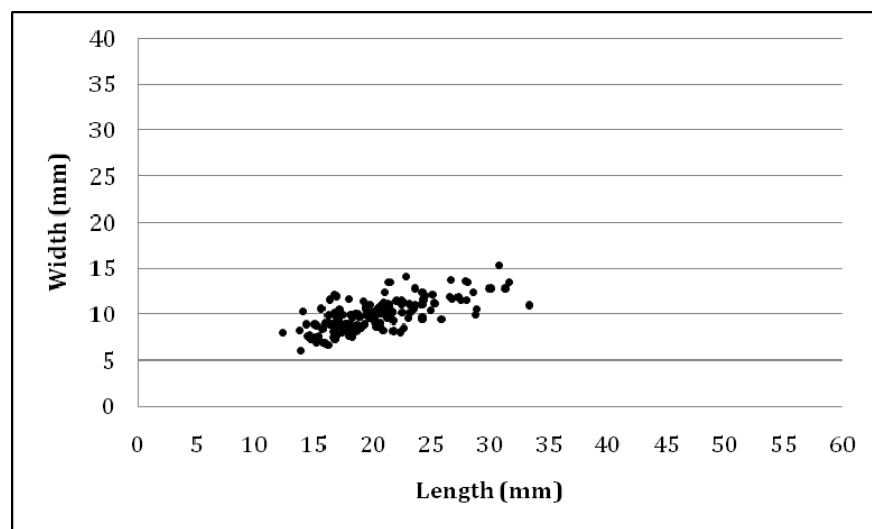

Figure 19: Scatter Plot Type 5 Flake Tools (n= 146).

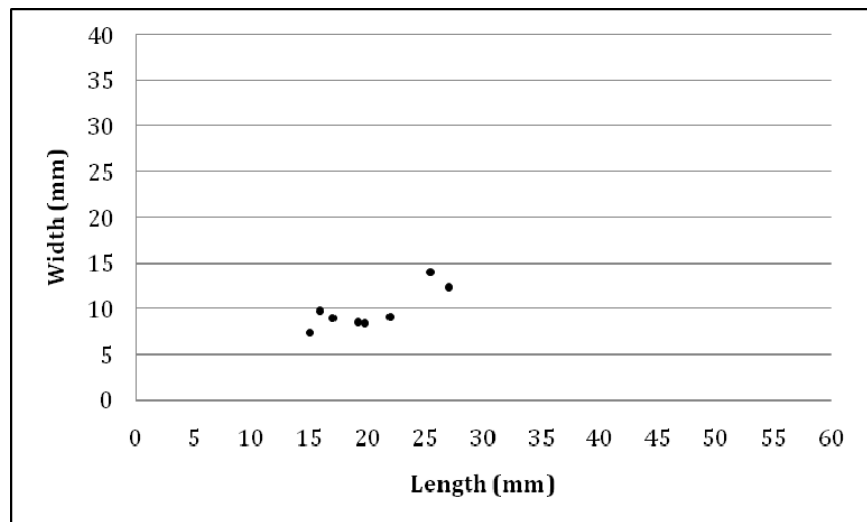

Figure 18: Scatter Plot Type 4 Flake Tools (n= 8).

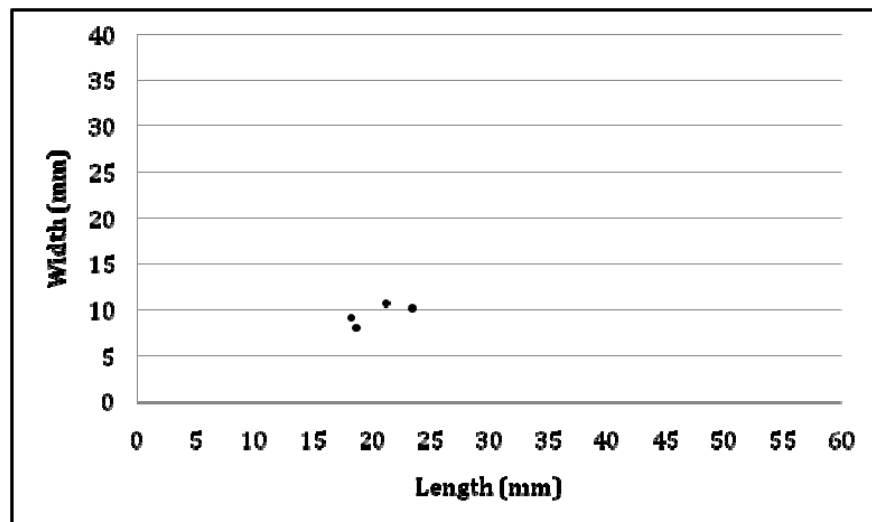
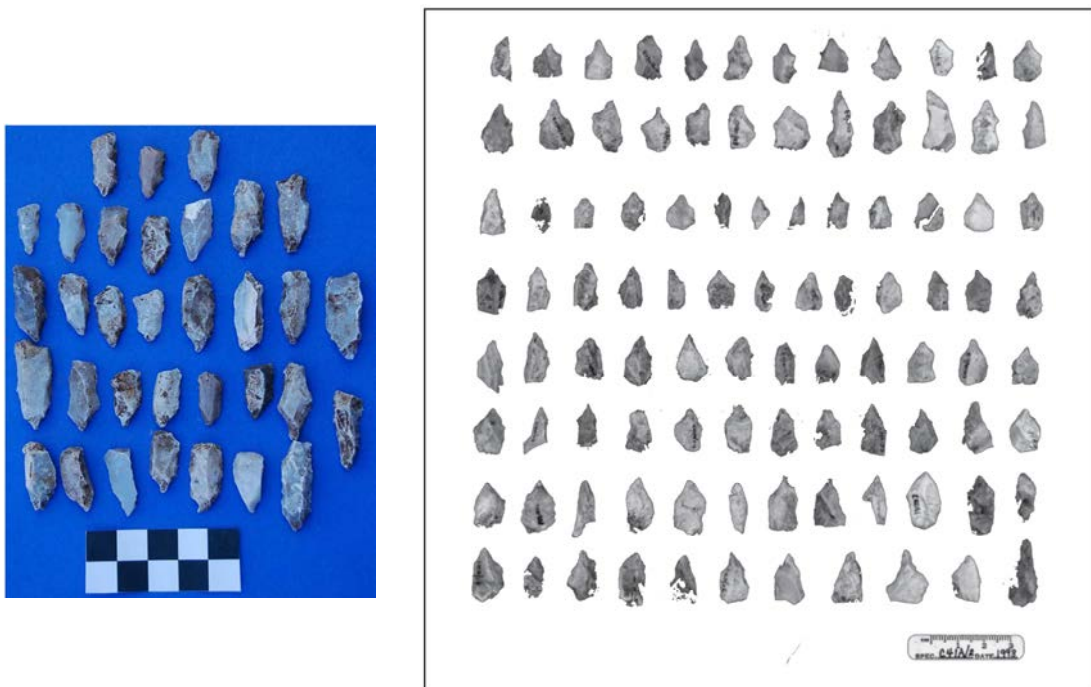

Figure 20: Scatter Plot Type 6 Flake Tools (n= 4).

Other Craft and Lithic Data from Caracol

Statistical data is also available from other craft production area at the site (Pope Jones 1996: 113, 117, 120, and 125). This data includes mean and standard deviation from “drills” collected during the 1991 field season. Pope Jones (1996) discusses tool standardization as an important feature of the tool assemblage, but does not quantify them using *CV* nor does she use any other statistical calculations. In an attempt to incorporate previous data with current data, this has been computed using length, width, and thickness ([Tables 14-16](#)). The comparisons between different craft areas are preliminary, at best, because earlier research did not use the same analysis convention used in this thesis and tools may have been used to work different kinds of materials (i.e., were drills for shell like drills for wood?). It is conceivable that comparisons are not justifiable. However, it is appropriate to compare these crafting areas to one another to determine if assemblages have similar degrees of standardization. In other words, do shell or bone working tools show the same degree of standardization when compared to tools thought to have worked wood? The answer is “yes.” In all the small chert tools collected and analyzed thus far and if grouped together by provenience and completeness, the *CV* % is low as a whole throughout all assemblages (with the exception of C56B/3 drill length, which might be due to the number of tools from this locus). These preliminary comparisons make clear that further research needs to be conducted in order to understand how spatially distinct craft areas differ. What would be the ideal or standard tool type for each workshop? How many would fall within the classification presented above? Overall, width appears the most standardized aspect of the entire sample. This is expected, however, as tool length can vary even in the manufacturing process or the removal blade flakes (see Pope Jones 1996: 123); but, width is often determined by the width of the initial flake and the subsequent shaping and reshaping by human hands.

Comparisons such as these indicate that whatever or wherever materials were worked, standards in the tool form and function are present. It is expected that a reanalysis of previous research would yield even closer associations between crafting areas in terms of tool standardization. It appears that tool type or plan form as described in this thesis appears in a large percent of the tools collected from other loci (see Pope Jones 1996:116) (Figure 21-22). This is further supported by the manufacturing techniques of drills and other small tools.



*Figure 21: (left) Sample of Chert Tools from C174E/3 (from A. Chase and D. Chase 2006)
(right) Sample of “Drills” from C41A/2 (after Pope Jones 1996:116, figure 8)*

Table 14: Summary CV Statistics of Drill Lengths.

Reference	Context	Tool feature*	Worked Material**	Number	Mean	SD	CV (%)
Pope Jones 1996:113	C32C	drill length	shell	n = 43	26.39	6.05	22
Pope Jones 1996:117	C41A/ 2	drill length	unknown	n = 98	17.8	2.7	15
Pope Jones 1996:120	C56B/ 3	drill length	unknown	n = 669	16.41	8.4	51
Pope Jones 1996:125	C4C/ 12	drill length	unknown	n = 164	24.39	6.28	25
This thesis	C174C, C174E	drill length	wood	n = 197	20.75	4.99	24
Totals/ Range of CV (%)				n = 1171			15-51

Note:* Tools may not necessarily be same type. **Suggested on the basis of the presence or absence of co-occurring artifacts and needs to be determined.

Table 15: Summary CV Statistics of Drill Widths.

Reference	Context	Tool feature*	Worked Material**	Number	Mean	SD	CV (%)
Pope Jones 1996:113	C32C	drill width	shell	n = 43	12.89	3.3	25
Pope Jones 1996:117	C41A/ 2	drill width	unknown	n = 98	10.7	2.0	18
Pope Jones 1996:120	C56B/ 3	drill width	unknown	n = 669	9.98	1.92	19
Pope Jones 1996:125	C4C/ 12	drill width	unknown	n = 164	10.7	2.79	26
This thesis	C174C, C174E	drill width	wood	n = 197	10.24	2.45	23
Totals/ Range of CV (%)				n = 1171			18-26

Note:* Tools may not necessarily be same type. **Suggested on the basis of the presence or absence of co-occurring artifacts and needs to be determined.

Table 16: Summary CV Statistics of Drill Thicknesses.

Reference	Context	Tool feature*	Worked Material**	Number	Mean	SD	CV (%)
Pope Jones 1996:113	C32C	drill thickness	shell	n = 43	7.97	2.66	33
Pope Jones 1996:117	C41A/ 2	drill thickness	unknown	n = 98	6.1	1.6	26
Pope Jones 1996:120	C56B/ 3	drill thickness	unknown	n = 669	5.70	1.67	29
Pope Jones 1996:125	C4C/ 12	drill thickness	unknown	n = 164	4.72	1.63	34
This thesis	C174C, C174E	drill thickness	wood	n = 197	5.69	1.72	30
Totals/ Range of CV (%)				n = 1171			26-34

Note:* Tools may not necessarily be same type. **Suggested on the basis of the presence or absence of co-occurring artifacts and needs to be determined.

CHAPTER FIVE: SUMMARY AND CONCLUSIONS

Using the above data and discussion, it is obvious that tools recovered from the Gateway Group were manufactured in large numbers and reflected a standardized or idealized form for functional purposes. If we return to the tabulated hypotheses presented in Chapter 1 (see [Table 1](#)), we can ask four basic questions of the data to determine household function and economic impact.

First, were tools standardized? Yes, standardization is present in at least 146 out of 175 complete tools or 83.4% based on plan form, maximum measurements, and individual side measurements together. More specifically, Type 5 tools with positive rejuvenation ($n=88$ or 72%) that are within 1 *SD* of the mean reflect the ideal (see [Tables 6](#) and [12](#)). Morphological associations, like edge angles, are also telling in terms of function. Other tool assemblages (Types 3, 4, and 6) also reflect similar degree of standardization, but do not occur in high numbers like Type 5 tools.

Second, did tools that had been used occur in trash deposits at this locus? If we assume that the construction fill materials that make up this research were deposited from the inhabitants of the group itself after the crafting process, then, yes, these tools were no longer usable for whatever reason and were gathered up then redeposited within construction fill. Perhaps the group discontinued the making of crafts.

Third, if we review the extensive excavation history at Caracol, only limited evidence for craft production areas are evident. Tools similar to these recovered from Structure B143 only occur at a limited number of residential groups and not at *all* households. Therefore, the majority of other households do not contain the number of tools necessary to qualify as a craft

production area like the Gateway Group or other groups near the Conchita Causeway (see Pope Jones 1996).

Lastly, do craft production areas at Caracol typically have a co-occurrence of crafting debris? Yes, although the current study did not because the associated material had presumably decomposed in the archaeological record. We can use chert debitage as a measure for the presence or absence of crafting debris. Based on the overwhelming amount of debitage removed from the relatively small excavation units, the Gateway Group practiced crafting. The full complement of lithic debitage tells us that the Maya created the chert tools at this locus and redeposited all the associated trash materials, including used tools, within construction fill. It is safe, then, to assume that crafting debris would have accompanied this crafting trash.

With this said, can we determine the function of this residential group? The data show that there is: 1) *high standardization*; 2) a *high* number of used tools present in the trash deposit; 3) a *low probability* of these kinds of tools appearing in other house groups at the site as compared to other excavated house groups; and 4) a *high* amount of lithic debitage present in the trash deposit relative to other excavated contexts. It is suspected that the craft being produced at this locus was made of wood or some other perishable material; therefore, we are not able to ascertain just how much of the craft debitage would have been present in the archaeological record. Regardless of the absence of this material, the data proves that this locus was a craft production area. Given that this residential group is not immediately adjacent to agricultural land, it is likely that the production of crafts may have been part- time or full- time during the Late or Terminal Classic Period, wherein a group of individuals created wealth by interjecting crafts into markets located in or near Caracol's epicenter.

Determining the specific function of a household synchronically is vital to our understanding of Maya economic and social models as a whole. At Caracol, we have spatial distribution evidence of craft production areas or “workshops” from palaces and residential groups (A. Chase and D. Chase 2004: 119). Most of this research has focused on two fundamental aspects of Caracol’s development, causeway organization and market placement. Understandably, units of production were inherently tied to these two features and contributed to their development as well. A. Chase and D. Chase (2004: 119) describe the residential groups as “widely scattered over the landscape,” meaning that craft production areas sometimes occur in nondescript residential groups at the site. If taken together, however, all craft areas excavated thus far tend to show that “production at Caracol was localized in households [non-barrio style complexes] and generally existed without state control, with the possible exception being that craft production locales located immediately adjacent to the epicenter and alongside the Conchita Causeway” (A. Chase and D. Chase 2004: 121). The Gateway Group is one such group located adjacent to the epicenter near the Conchita Causeway and therefore may have been controlled by the state in both the production and distribution of goods.

It has been argued the Maya elite at Caracol may have controlled the means of distribution, but not the means of production (A. Chase and D. Chase 2004). The Gateway Group is a possible exception because of its lack of agricultural associations and its proximity to epicentral constructions and management. Crafters at the locus were not simply supplementing agricultural income as described by other research (Pope Jones 1996), but rather may have set up shop for a *directed* and *managed* period of time due to its location near to the epicenter. It is therefore possible that during the Late Classic to Terminal Classic Period (AD 550-900), this craft workshop was initiated and managed by the epicentral elite. It is also possible that this

residential group may reflect a spontaneous “ad hoc” workshop that existed just out of reach of the epicentral elite. Either way, this group manufactured their standardized tool kit to produce crafts at a reasonable scale and was located near the epicenter and was, thus, able to participate in the market system at Caracol. This is consistent with current interpretations of the local economy at Caracol (A. Chase and D. Chase 2007). The current economic model from Caracol posits that because of the connectedness of the causeway systems and the location of markets in the epicenter and specifically at or near causeway termini that the Gateway Group would have been subject to state control over the distribution of its crafts regardless of its control over production.

Detailed lithic analysis from the Gateway Group at Caracol, Belize reveals insights into standardization of chert tools and, thus, the nature of a craft production locus in use during the Late to Terminal Classic Period. To accomplish this, four basic hypotheses were developed and tested using detailed analysis of particular lithic artifact types. A detailed analysis is vital for assessing all aspects of flake stone materials. The quantification of observed data on chert tools illuminated levels within the organization of production in terms of standardization. The degree of production organization or standardization is vital in determining the economic successfulness of a household and its effect on local networks of exchange.

This type of research is surprisingly scant in the literature and is in need of further attention. However, is not surprising given the lack of intensive excavation outside epicentral architecture at large Maya sites. Research literature on Caracol has typically been concerned with understanding the development and functionality of a large city and its urban traditions (A. Chase and D. Chase 2007). Economic models are developed through the interpretation of the archaeological record (e.g., artifacts and households remains); therefore, the analysis of

particular artifact assemblages from craft production units allows archaeologists to understand economic units of production. The organization and scale of the crafting phenomena is vital to rethinking economic models (e.g., A. Chase et al. 2008).

The data from the Gateway Group prove that craft production was taking place in household units and the lithic evidence shows that chert tools were standardized within these craft production units, demonstrating a high level of organization (Costin 1991, 2001). Taken as a whole, the craft production evidence from Caracol coupled with the network of causeways and the presence of markets supports the economic integration of Caracol's inhabitants during the Late to Terminal Classic Period.

Suggestions for Future Research

The implications of determining ideal tools types for contemporaneous craft production loci within Caracol or any archaeological site would create a database that has analytical and comparative significance across cultural boundaries. With this in mind, archaeologists might actually be able to develop more complete intra-site models for social and political control as it pertains to craft production and economy. To date, the study of standardization and small chert lithic tools in the craft production process is under-developed in the Maya area.

In terms of understanding craft production at Caracol specifically, I wish to make several suggestions for future research. First, a complete excavation of Structure B143 would be desirable, as this would determine if more tools or other tool types are present. Complete aerial excavation might also establish how building platforms are filled in with household refuse and how behavioral patterns of refuse disposal might be identified archaeologically. Most certainly, a reanalysis of the location of chert tools and debitage at Caracol's craft production areas will

illuminate ancient behavioral activities regarding how (and possibly when) lithic materials were disposed of and where archaeologists might find them during both survey and excavation. I question assumptions regarding the location of ancient refuse disposal for the ancient Maya as a whole; therefore, archaeologists should create a range of trash disposal options based on the excavation results from individual cases.

Second, a reanalysis of other craft areas at Caracol is absolutely necessary. This reanalysis should apply the morphological analysis and statistical methods presented in this thesis to create cross-comparisons between craft production loci. When these comparisons are made, it will create intra-site comparisons and provide a basis for a true synchronic view of an economic system that includes most members of an ancient society; only then can we talk about the agents or people of the production and economic system.

Third, a discussion of the agents within Caracol's local economy will provide a deeper and more comprehensive consideration of ancient behavior as well as control over resource procurement, manufacture, and distribution of craft items during the Late and Terminal Classic Periods (AD 550-900). To be sure, this discussion will add to a growing corpus of craft production and economic literature, thereby suggesting alternative and/or more comprehensive economic models based on both the testing of the archaeological record and a detailed analysis of the artifactual materials.

APPENDIX A: TYPE 1-3 FLAKE TOOLS

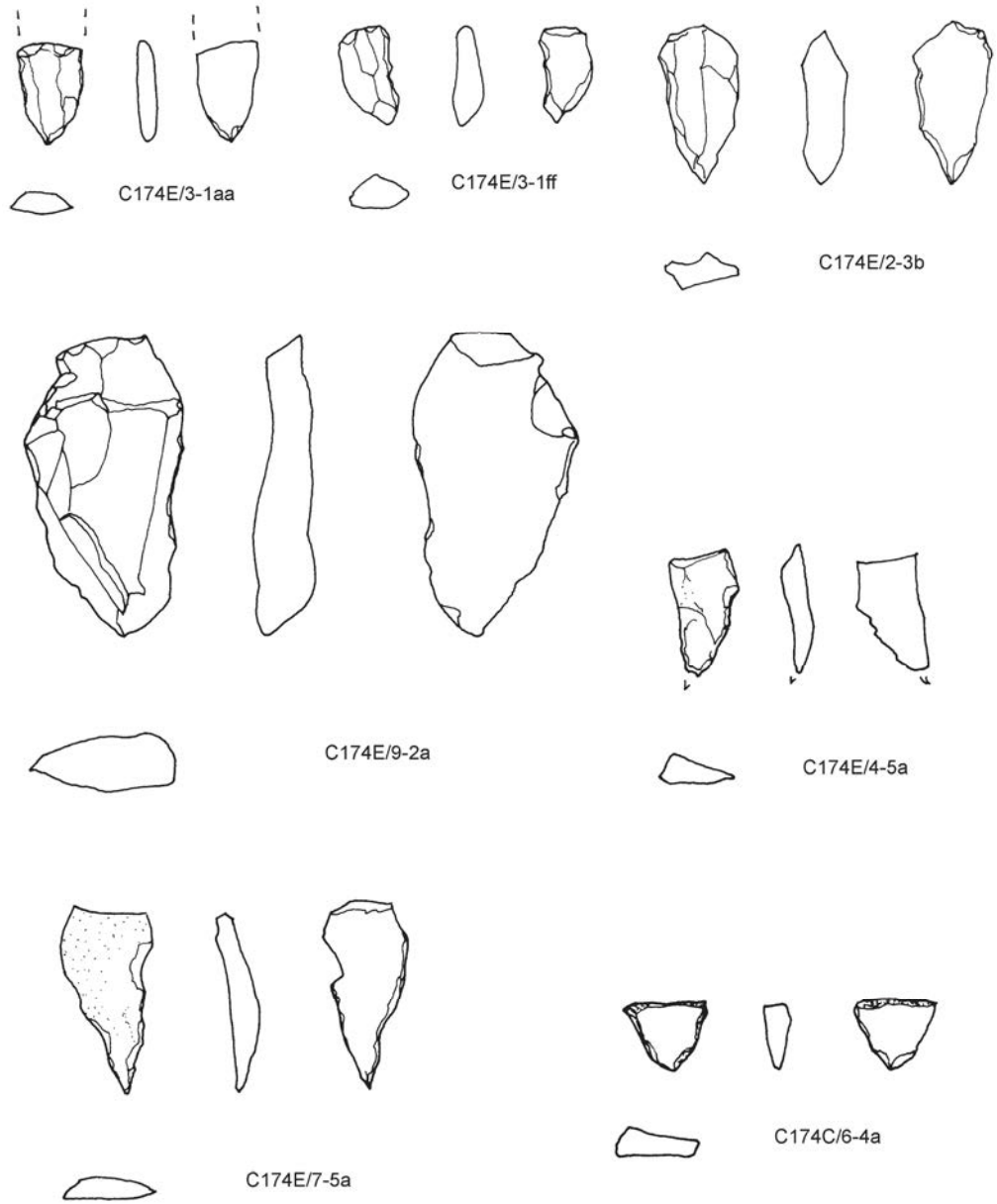

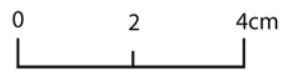
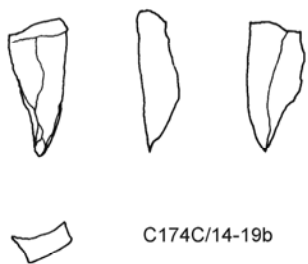
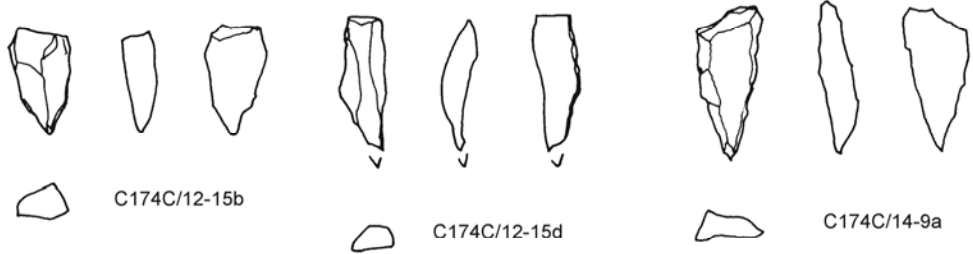
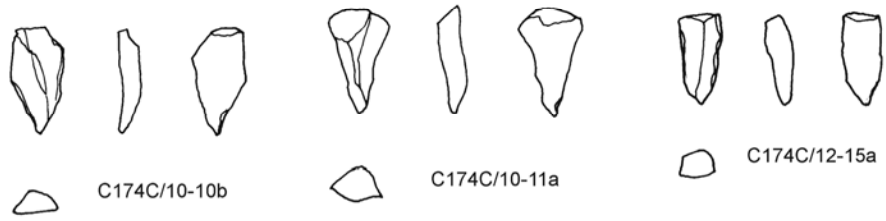
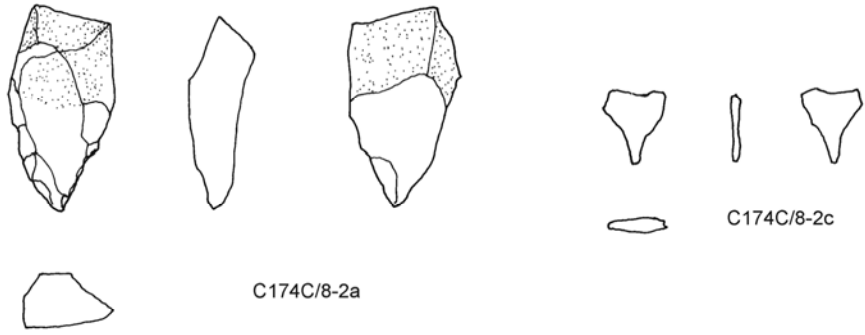

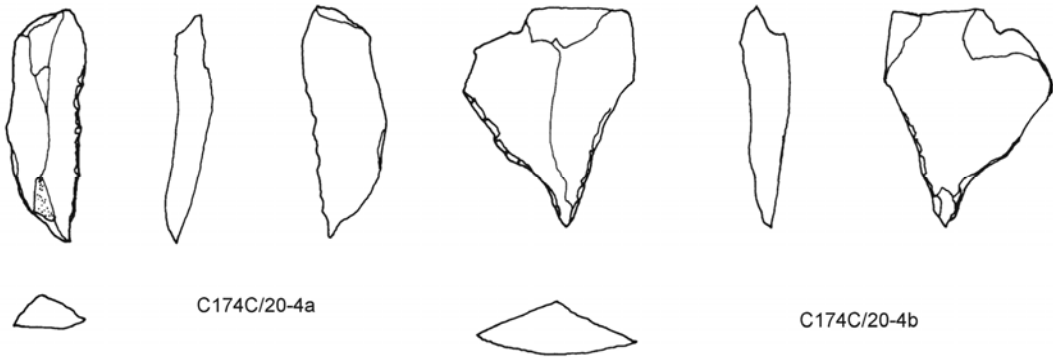

C174C/20-4a

C174C/20-4b

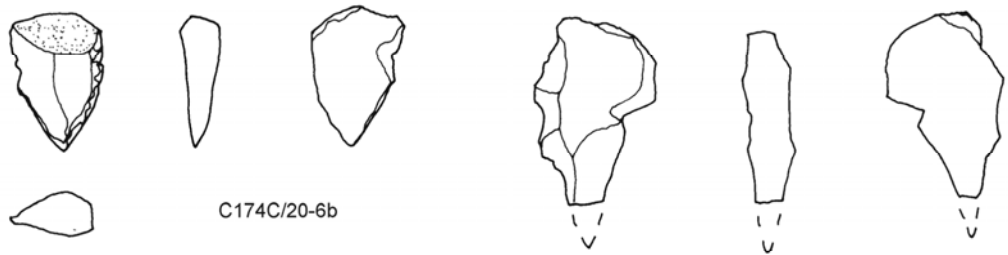

C174C/20-6b

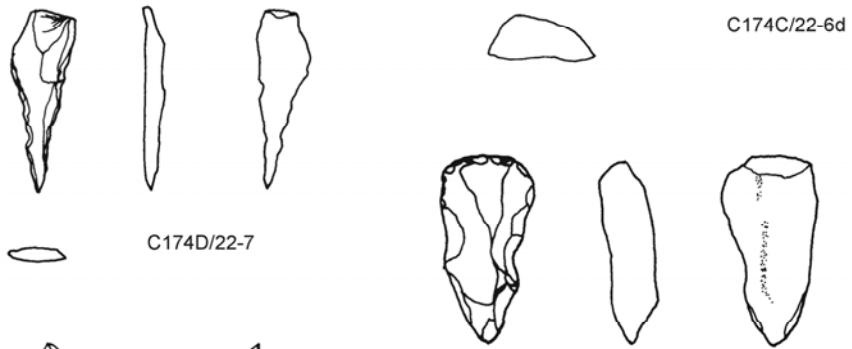

C174D/22-7

C174C/22-6d

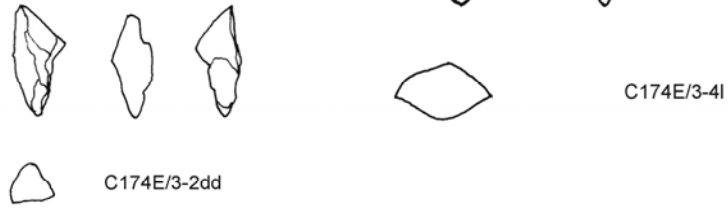

C174E/3-2dd

C174E/3-4l

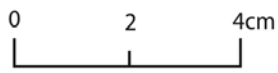

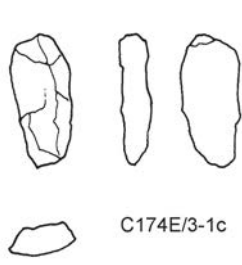

C174E/3-1c

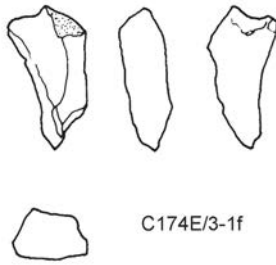

C174E/3-1f

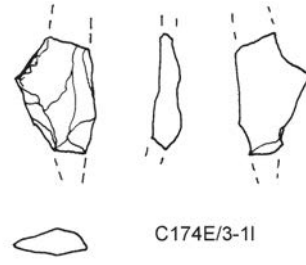

C174E/3-1l

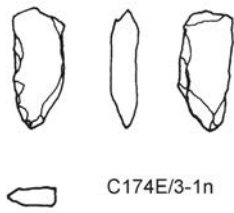

C174E/3-1n

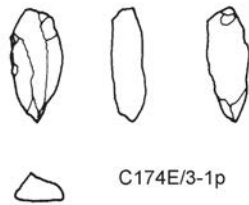

C174E/3-1p

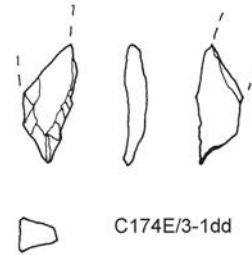

C174E/3-1dd

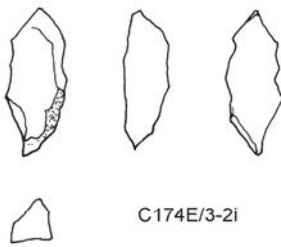

C174E/3-2i

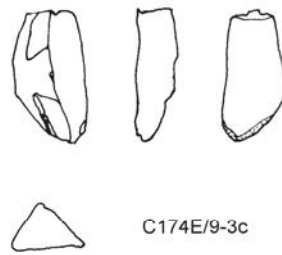

C174E/9-3c

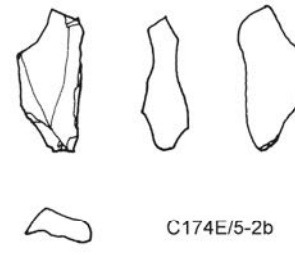

C174E/5-2b

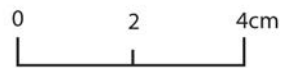

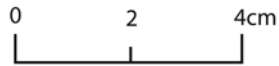
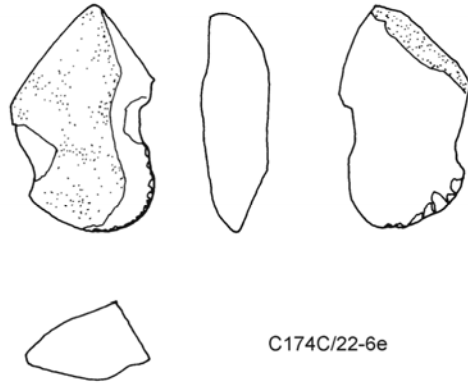
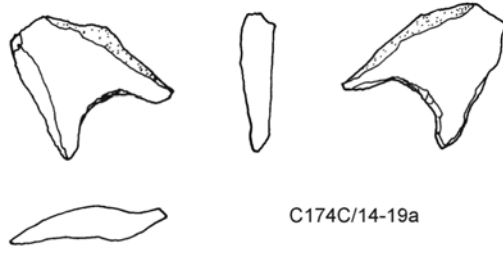

APPENDIX B: TYPE 4 FLAKE TOOLS



C174E/3-2g



C174E/9-2d



C174E/8-4a



C174C/8-2b



C174C/10-11b



C174C/11-2c



C174C/12-14



C174E/3-2n

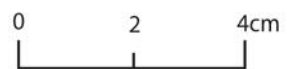

APPENDIX C: TYPE 5 FLAKE TOOLS

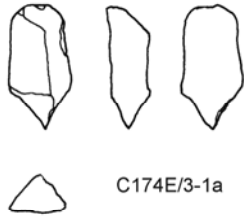

C174E/3-1a

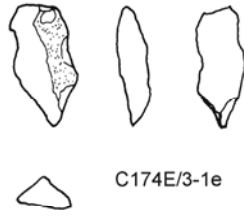

C174E/3-1e

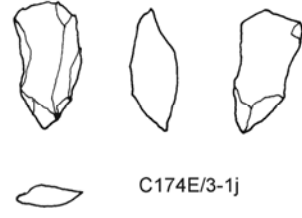

C174E/3-1j

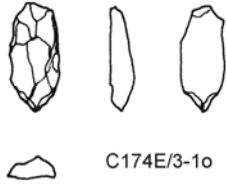

C174E/3-1o

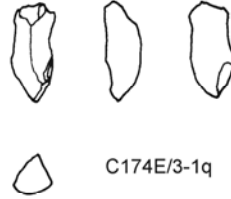

C174E/3-1q



C174E/3-1s



C174E/3-1t

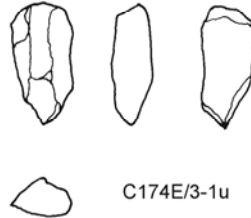

C174E/3-1u



C174E/3-1ee

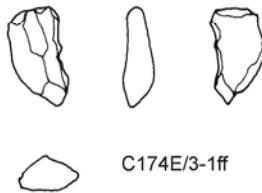

C174E/3-1ff

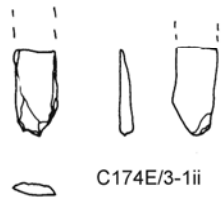

C174E/3-1ii

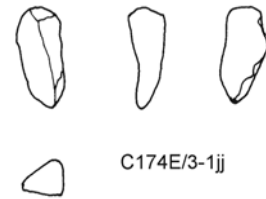

C174E/3-1jj

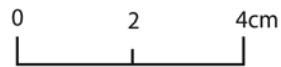

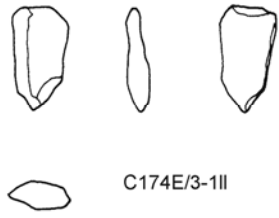

C174E/3-1ll

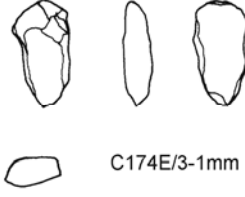

C174E/3-1mm

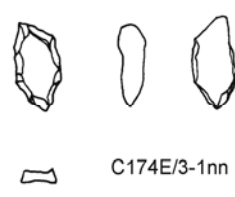

C174E/3-1nn

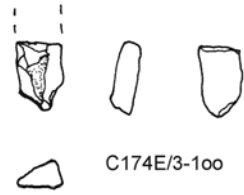

C174E/3-1oo



C174E/3-1tt



C174E/3-1uu

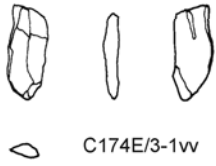

C174E/3-1vv

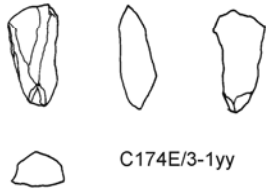

C174E/3-1yy



C174E/3-1zz

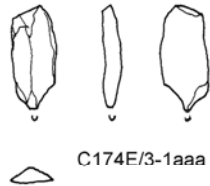

C174E/3-1aaa



C174E/3-1bbb



C174E/3-1ddd

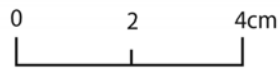

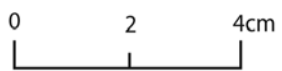
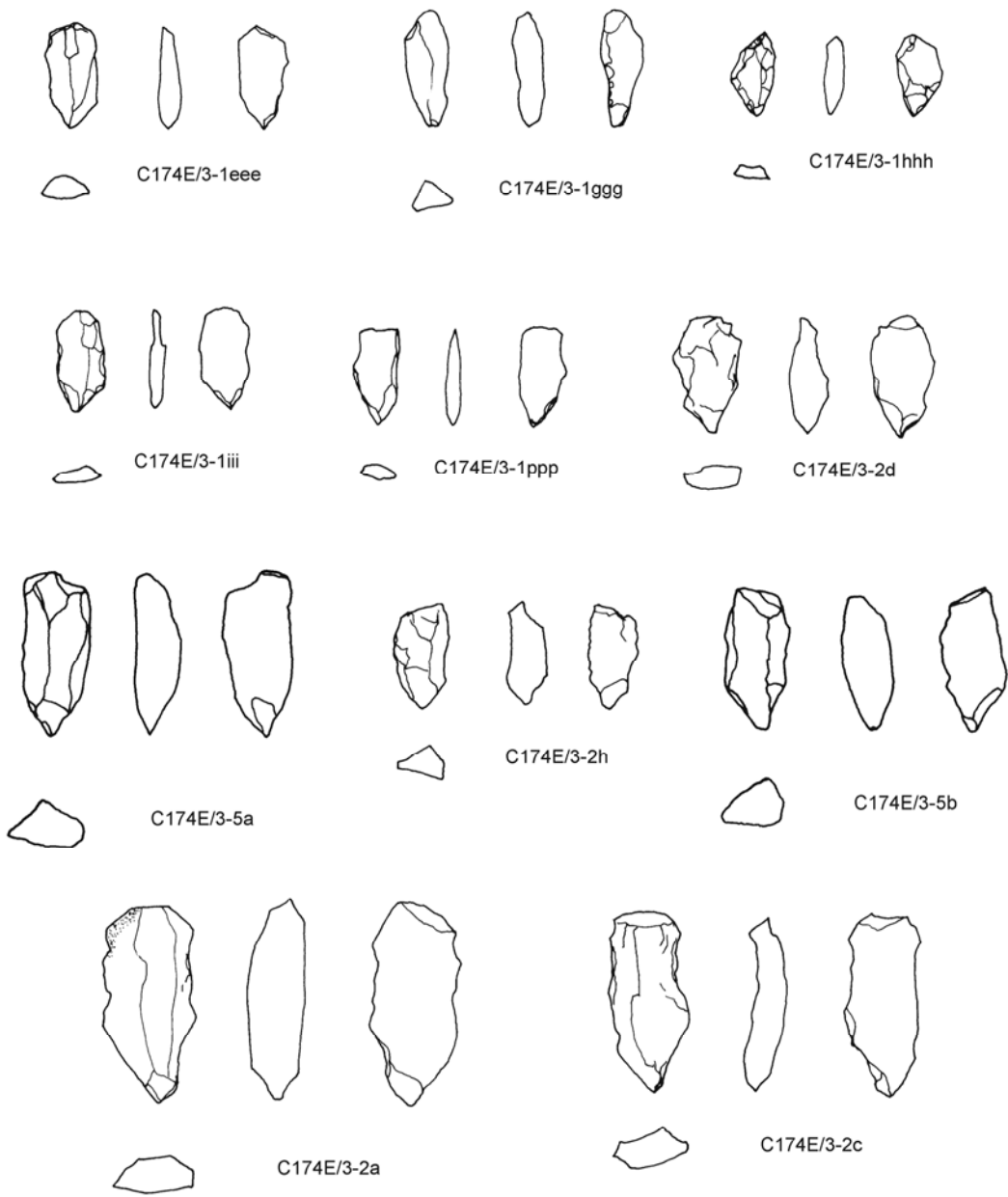

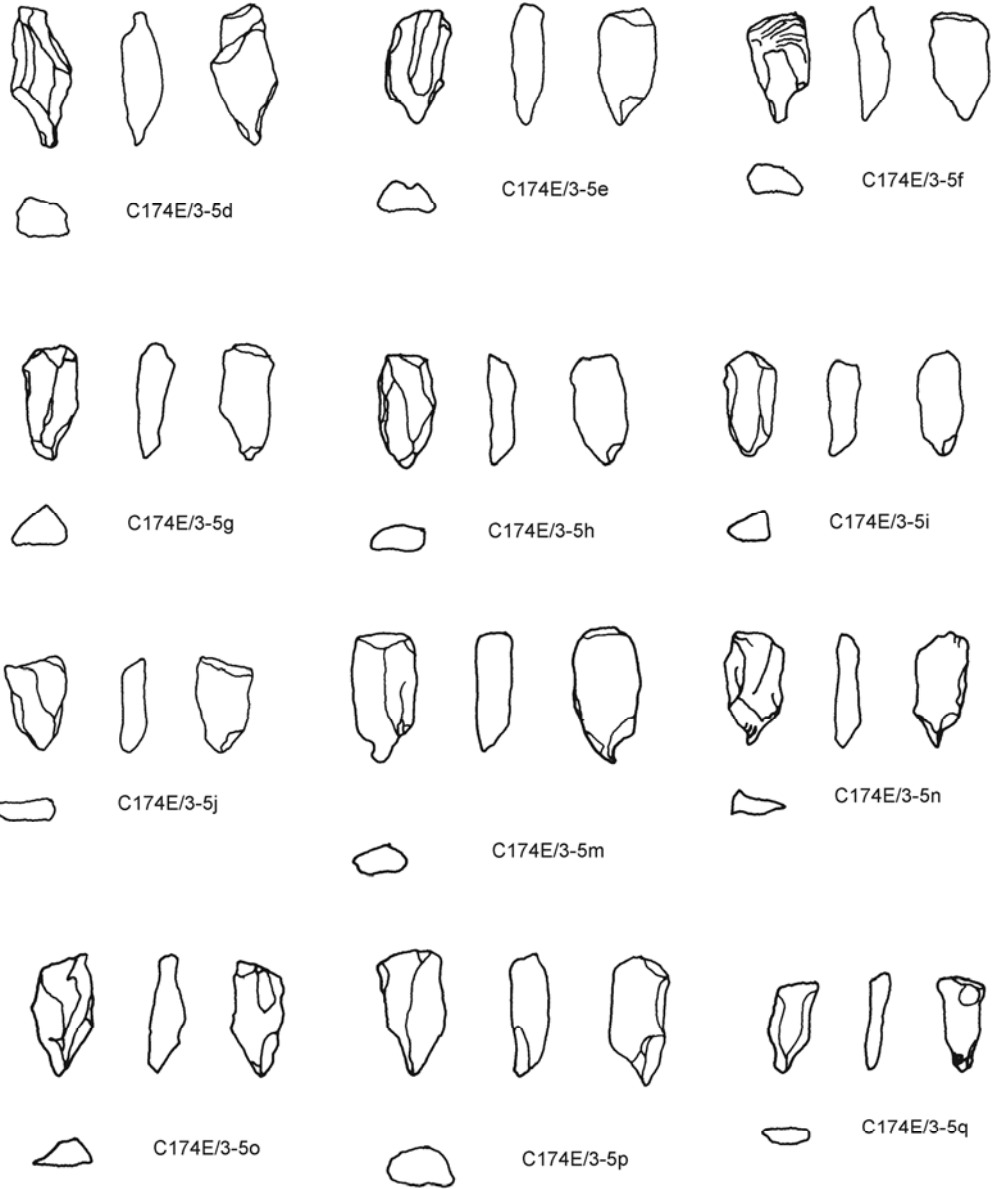

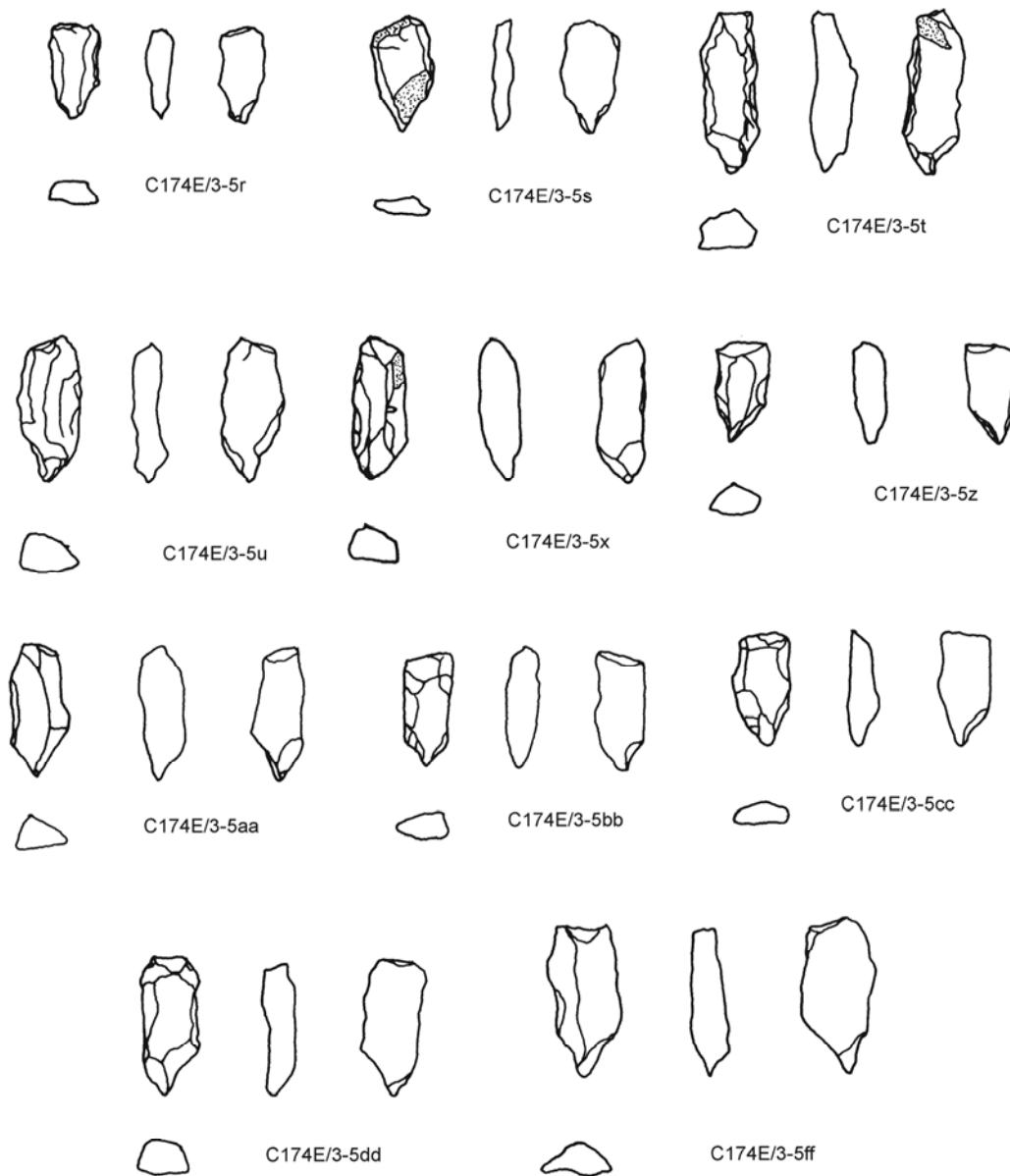

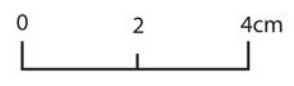
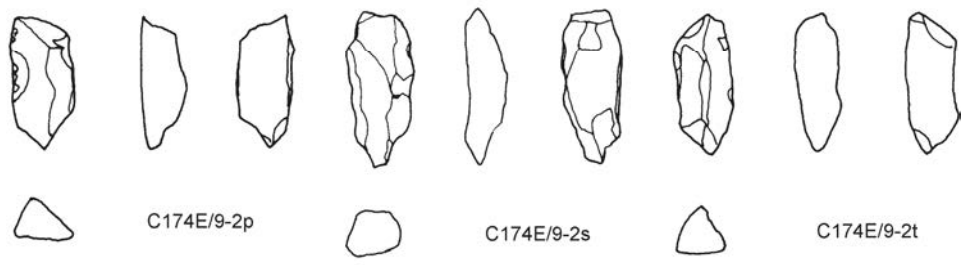
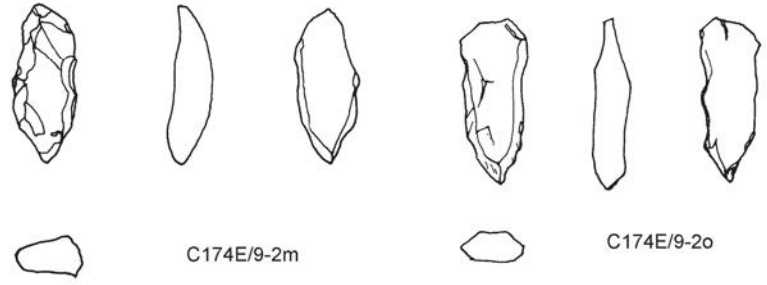
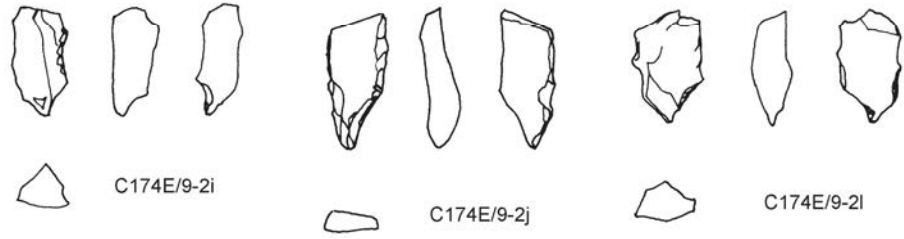
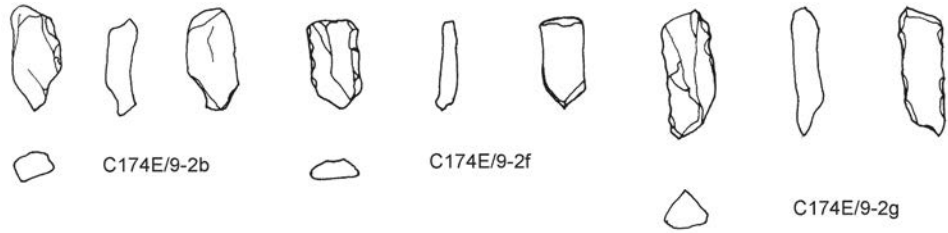

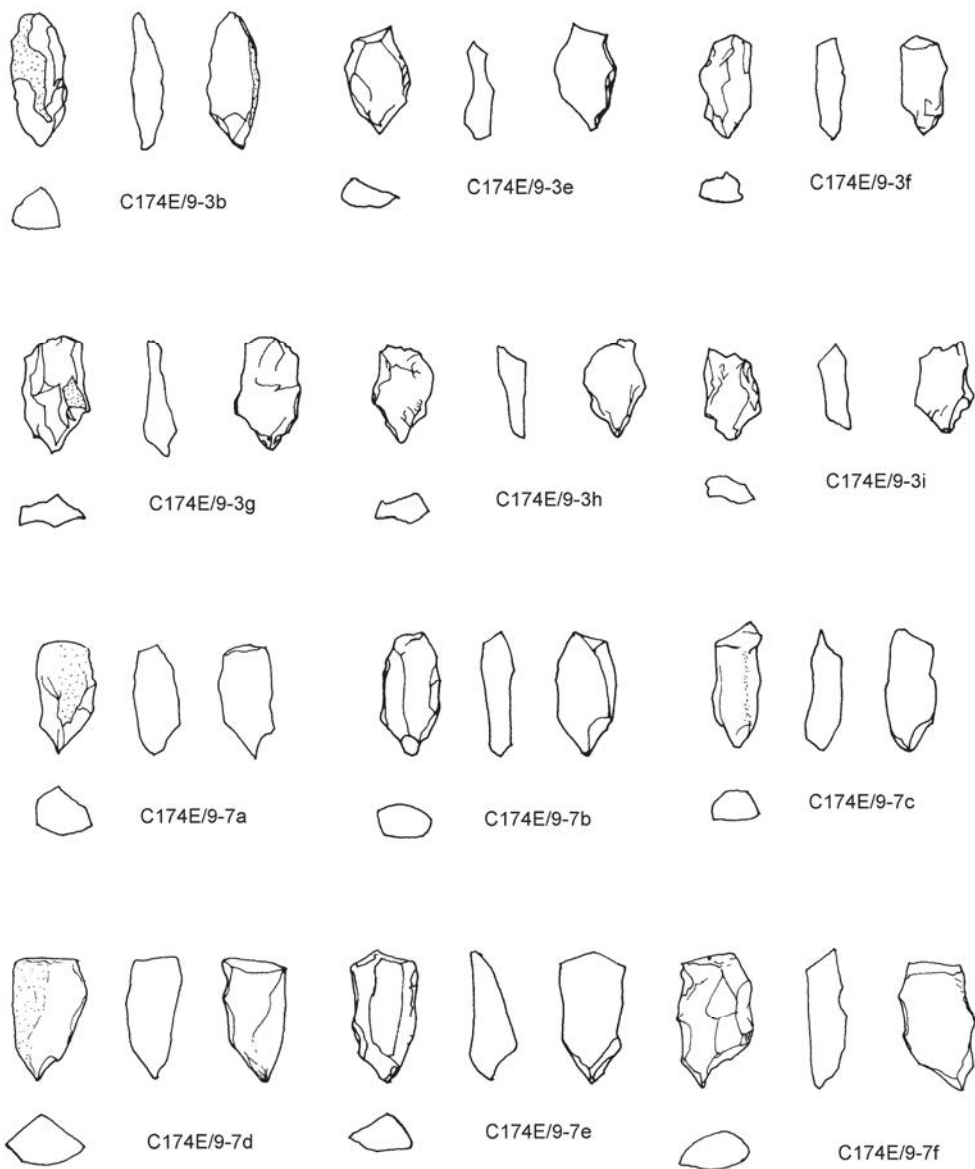

0 2 4cm

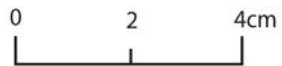
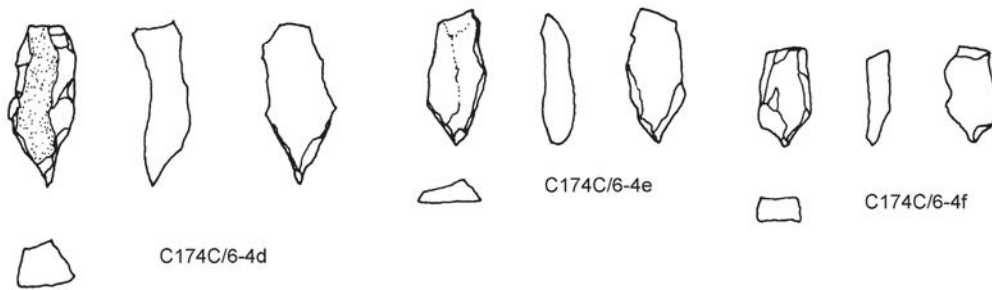
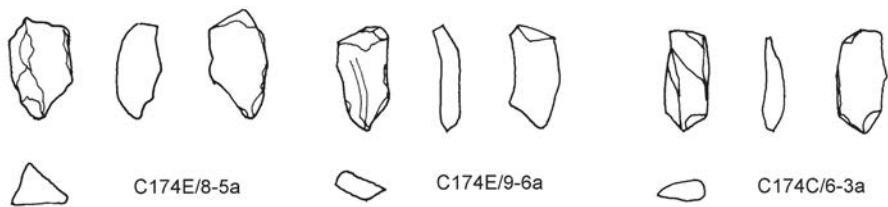
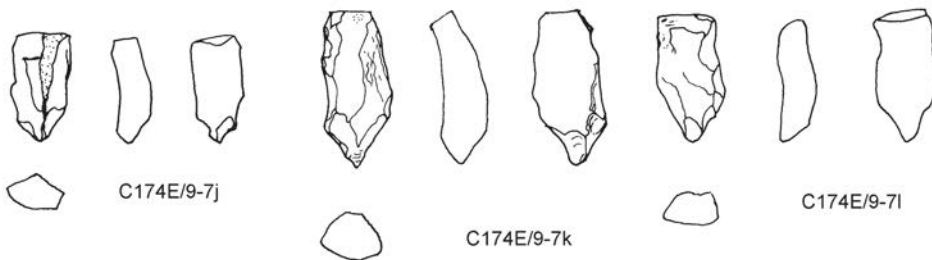
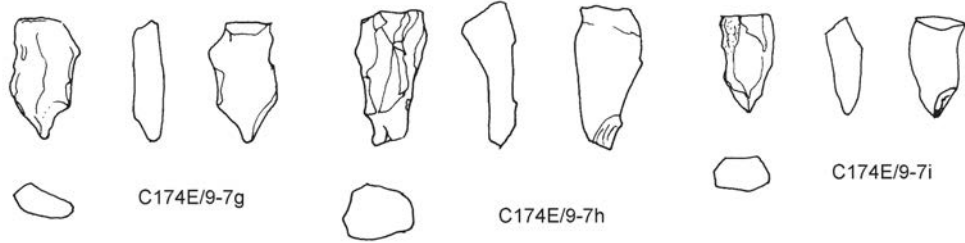

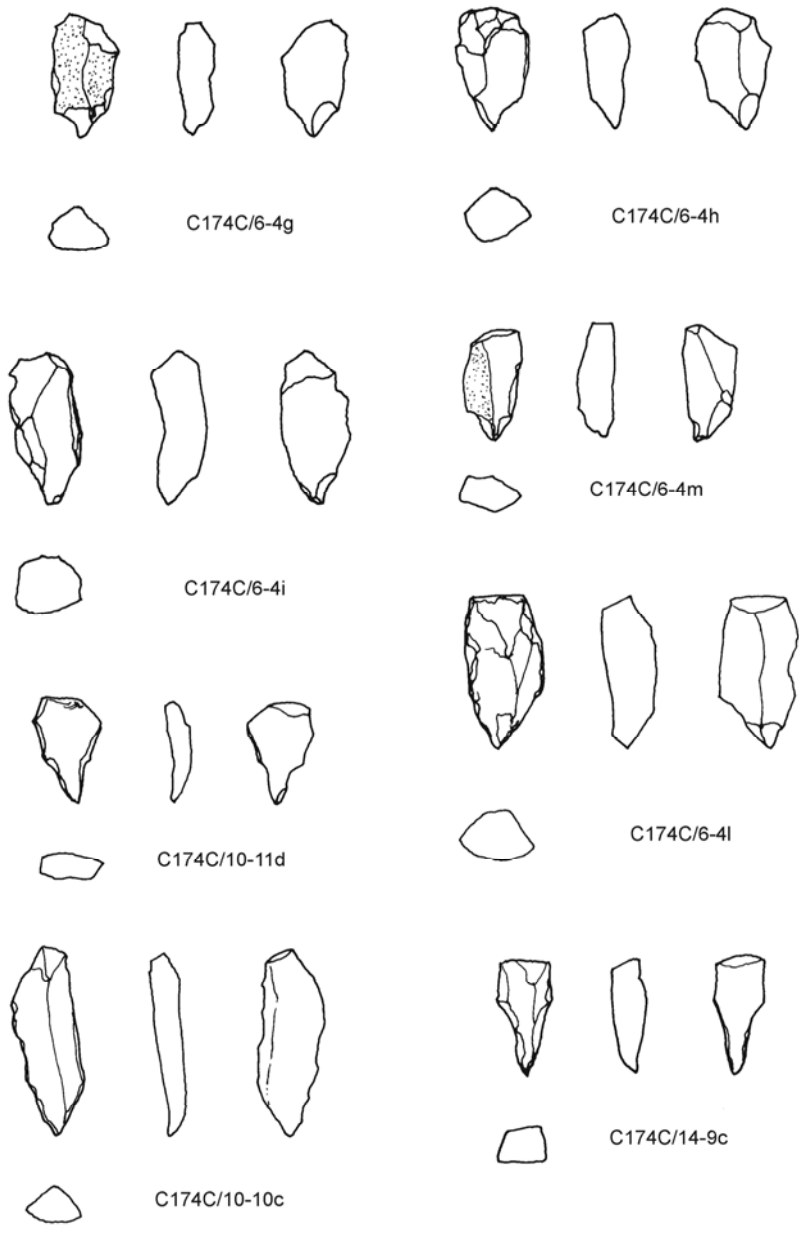

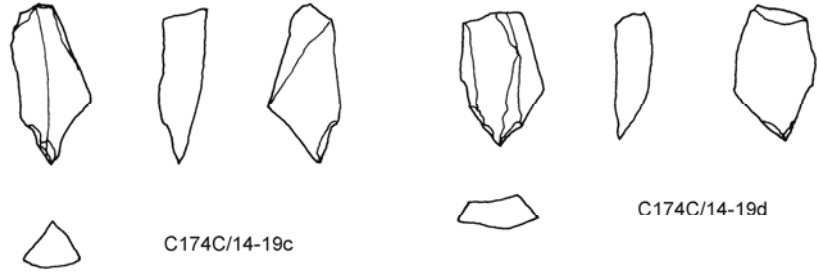

C174C/14-19c

C174C/14-19d



C174C/15-7a

C174C/20-6a

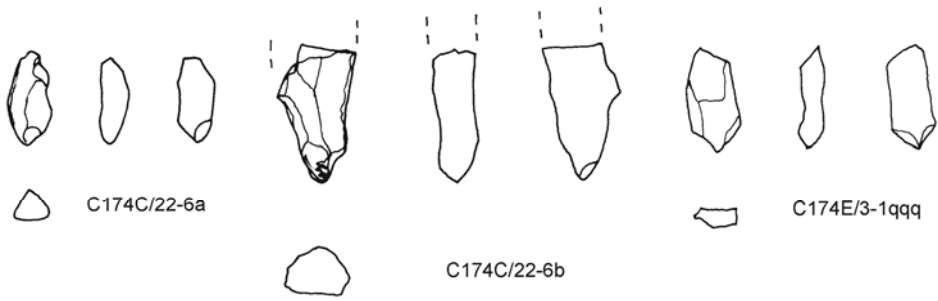

C174C/22-6a

C174C/22-6b

C174E/3-1qqq

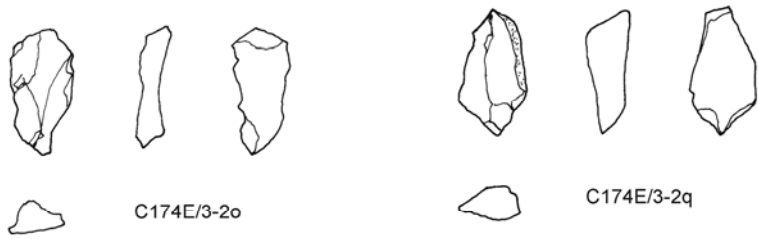

C174E/3-2o

C174E/3-2q

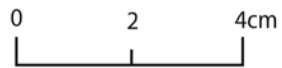

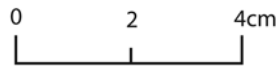
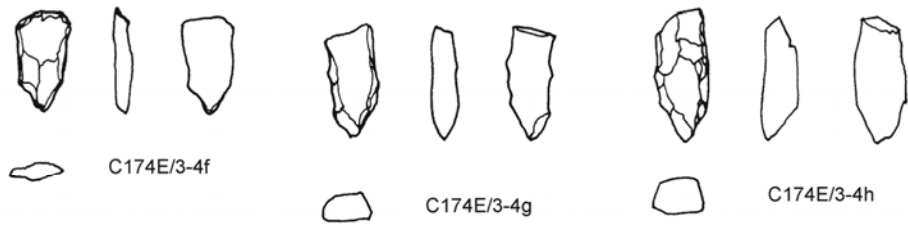
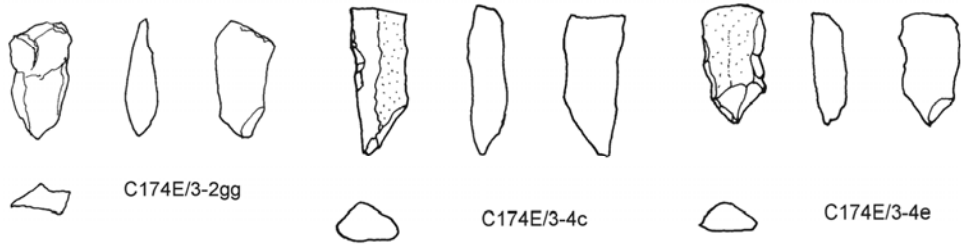
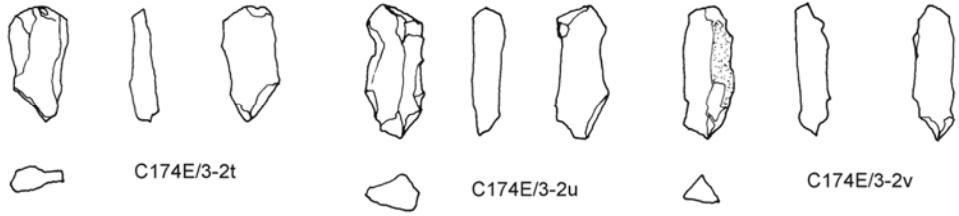

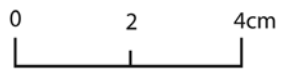
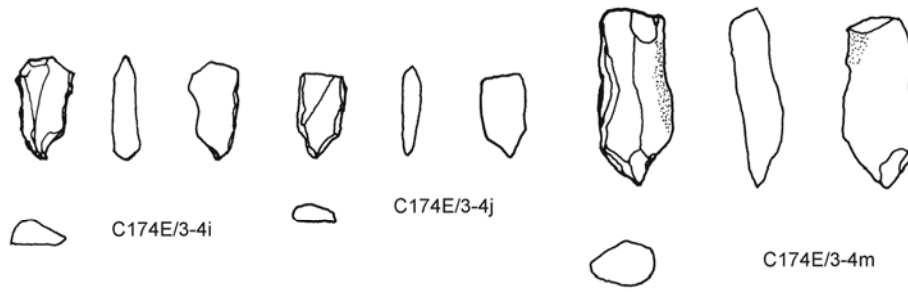

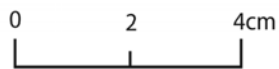
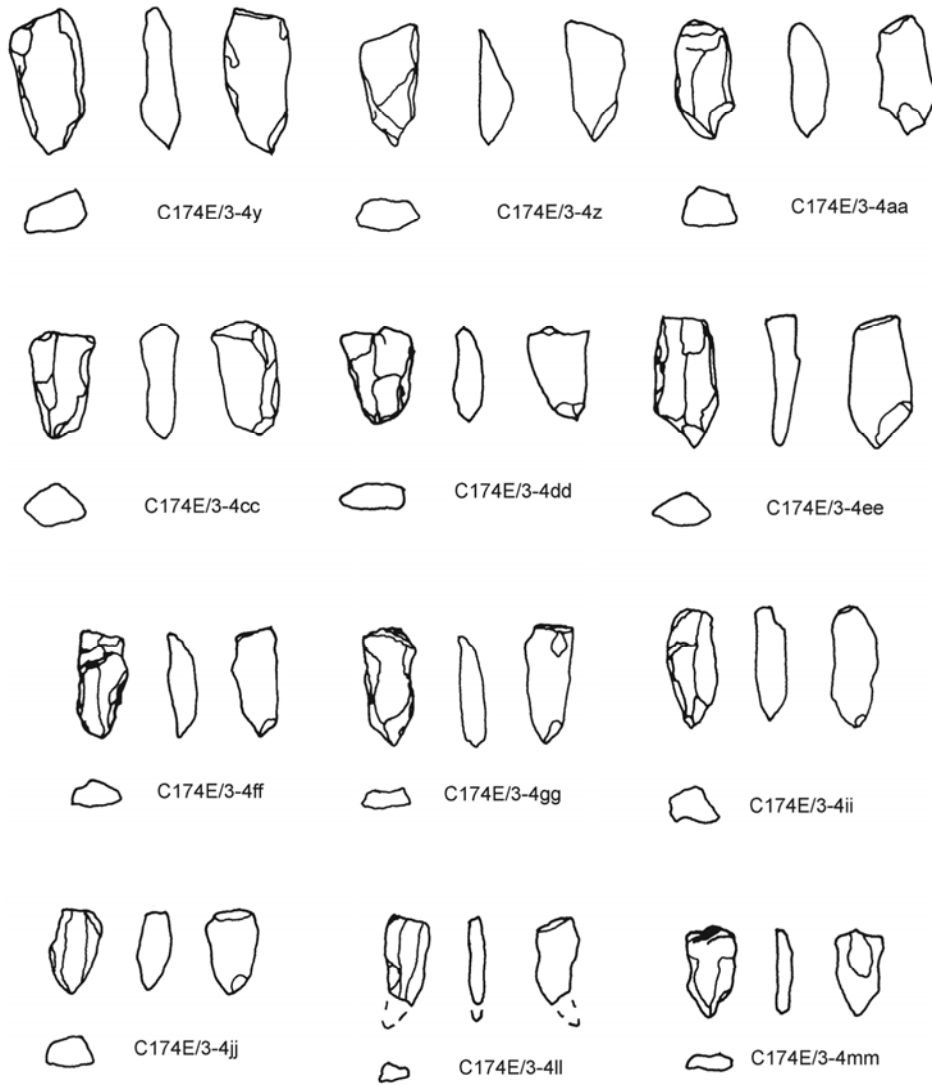

APPENDIX D: IDEAL TYPE 5 (n=51)

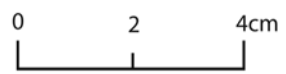
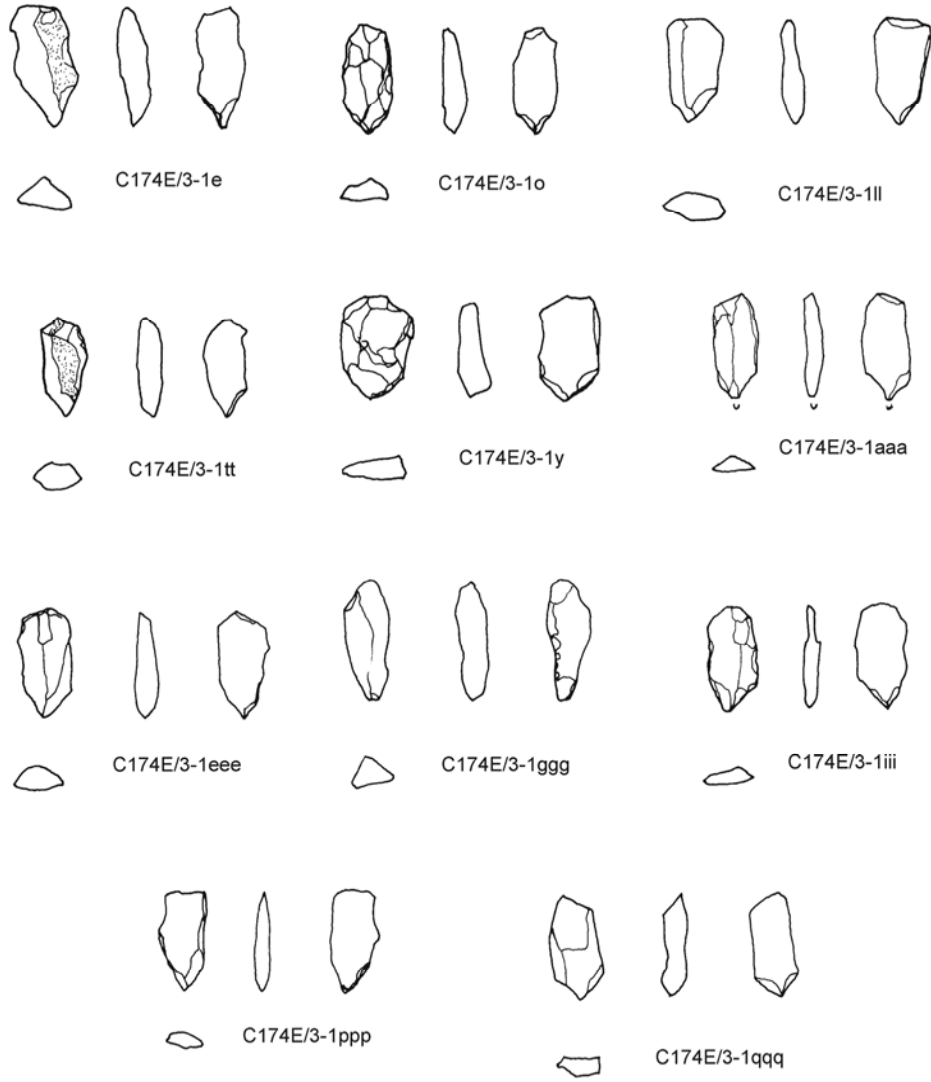

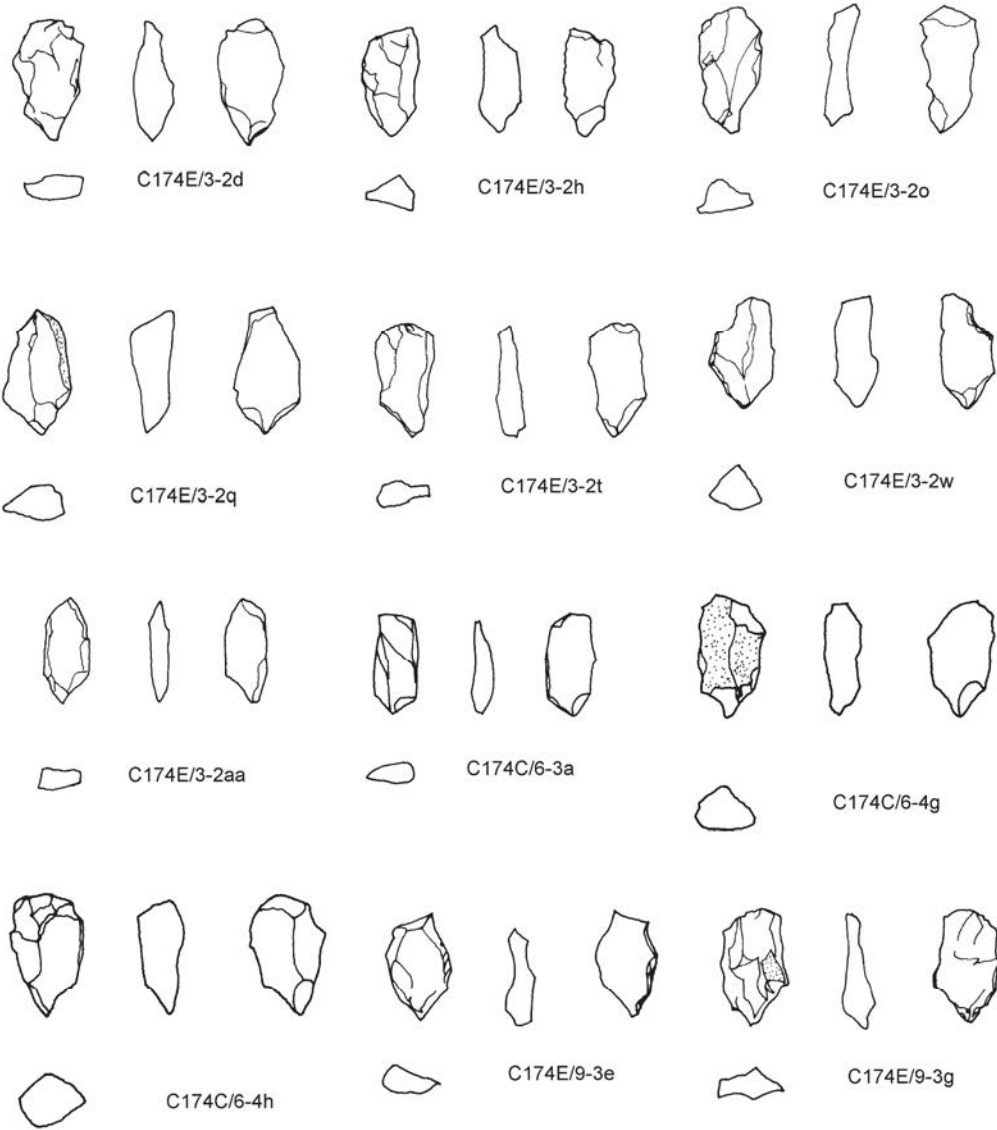

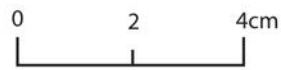
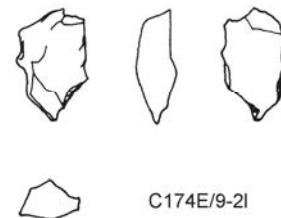
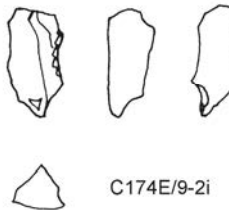
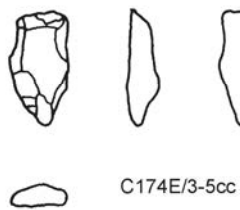
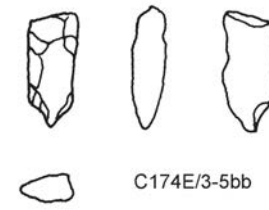
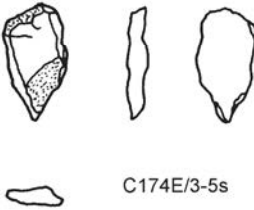
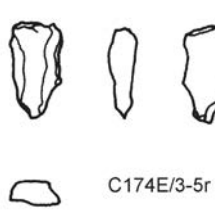
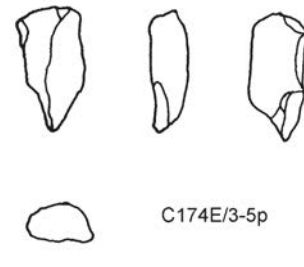
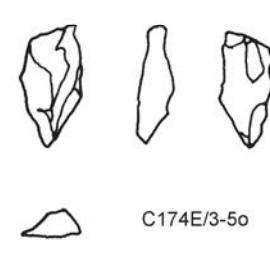
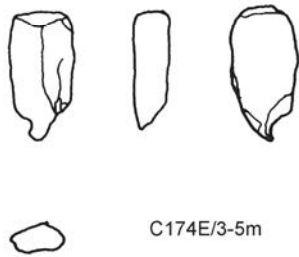
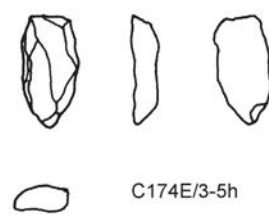
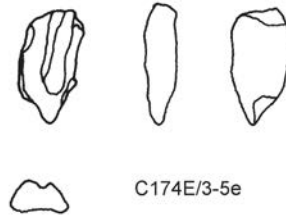
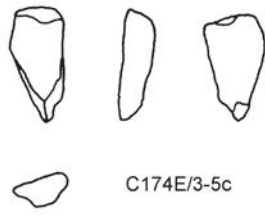

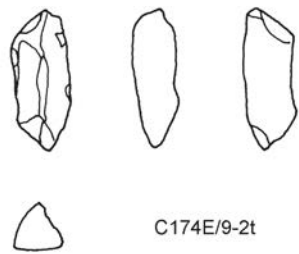

C174E/9-2t

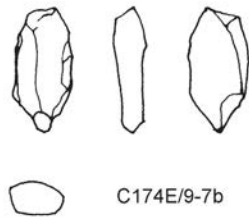

C174E/9-7b

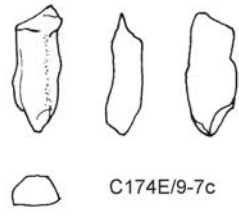

C174E/9-7c

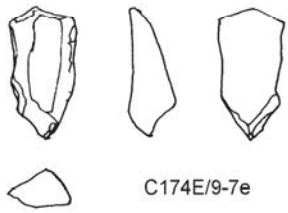

C174E/9-7e

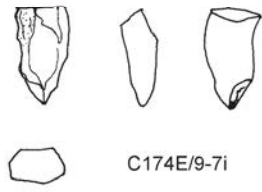

C174E/9-7i

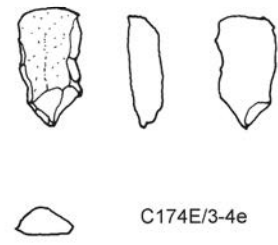

C174E/3-4e

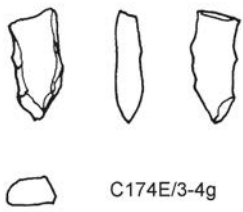

C174E/3-4g

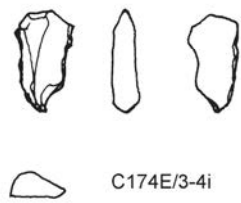

C174E/3-4i

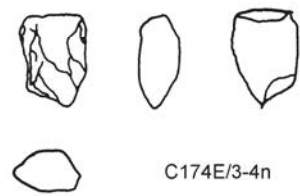

C174E/3-4n

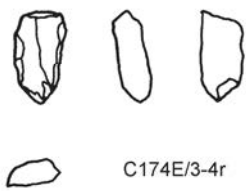

C174E/3-4r

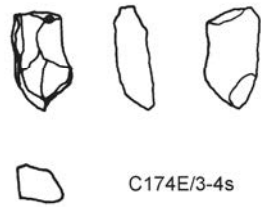

C174E/3-4s

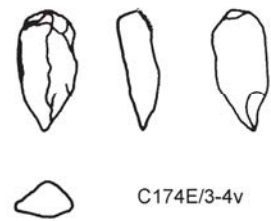

C174E/3-4v

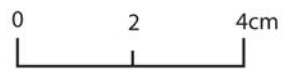



C174E/3-4x

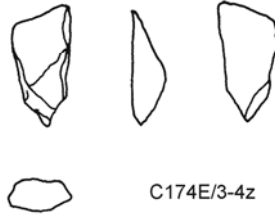

C174E/3-4z

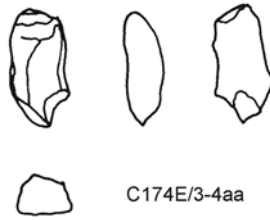

C174E/3-4aa



C174E/3-4ff

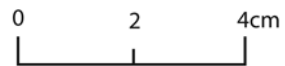

APPENDIX E: TYPE 6 FLAKE TOOLS

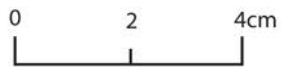
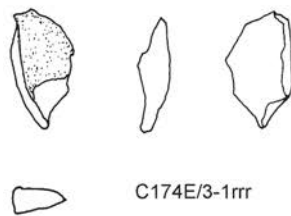
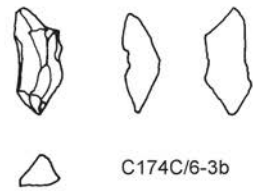
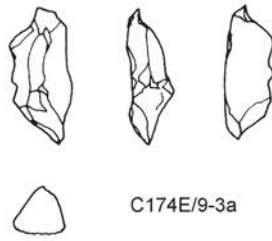
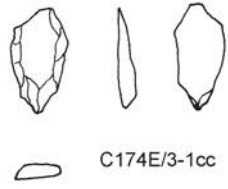

APPENDIX F: CHERT ARTIFACTS OF INDETERMINATE TYPE

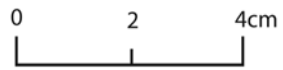
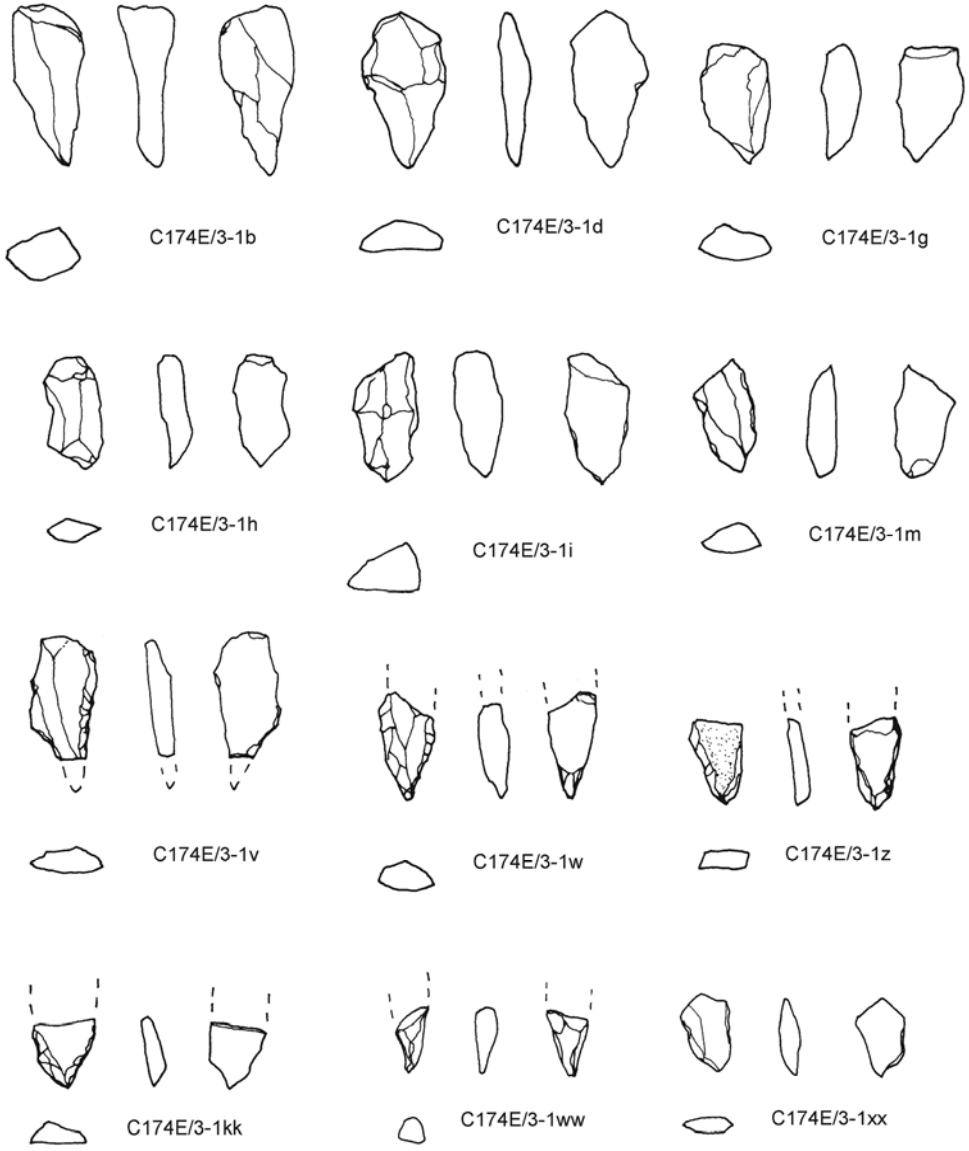



C174E/9-2c



C174E/9-2e



C174E/9-3d

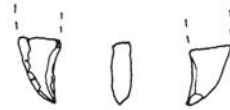

C174E/3-1III

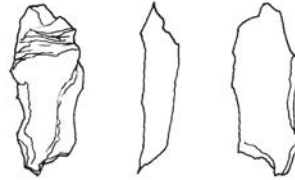

C174E/3-2j

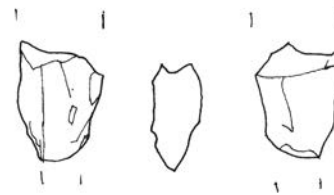

C174E/9-3j



C174E/3-1kkk

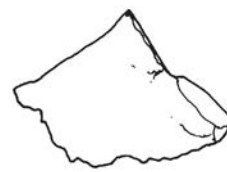

C174C/6-4k

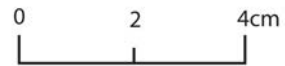

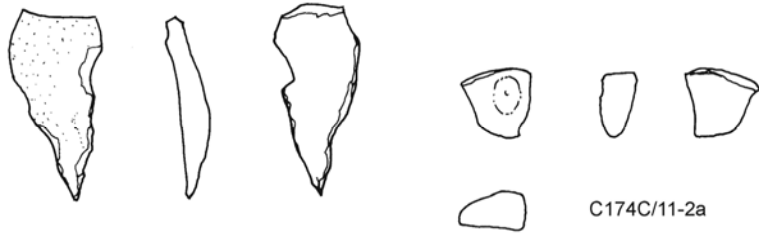

C174E/7-5a

C174C/11-2a

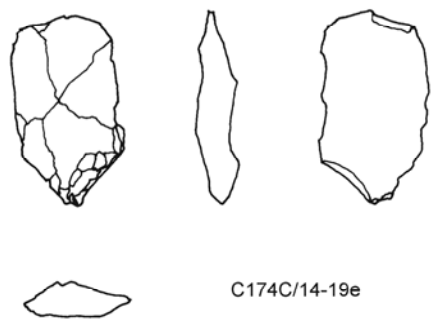

C174C/14-19e



C174D/16-6

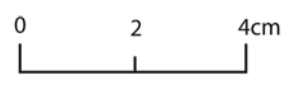

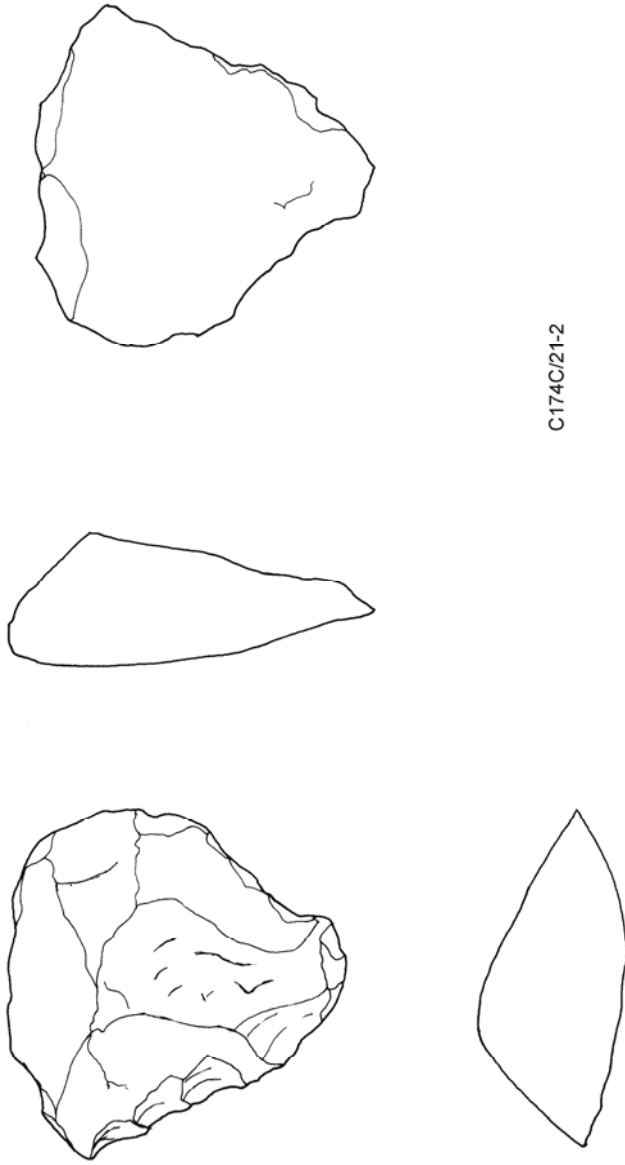

C174C/21-2

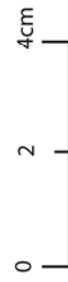

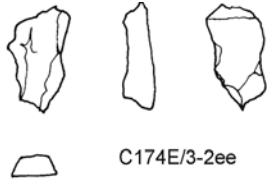

C174E/3-2ee



C174E/3-2ff



C174E/3-4hh

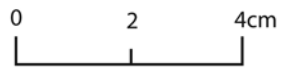

APPENDIX G: FLAKE TOOL ANALYSIS KEY

1. CATALOGUE #

e.g. C174E/ 3-1 a, C174E/ 3-1 aa

2. ARTIFACT FUNCTION 1 AND 2

1. drill
2. scraper
3. incisor
4. burin/ awl
5. scraper/ incisor
6. drill/ incisor/ scraper
7. chisel
8. blank
999. indeterminate

3. COMPLETENESS

1. whole
2. broken – no further information
3. proximal fragment
4. midsection
5. distal fragment
6. proximal – midsection
7. distal – midsection
8. longitudinal
9. auricle

4. MATERIAL COLOR

1. grey/ white banded
2. grey/ white mottled
3. grey banded
4. brown/ grey mottled
5. white
6. brown/ grey
7. light brown
8. brown/ grey banded
9. grey
10. brown

5. LENGTH (mm)

(-) = incomplete/ broken

6. WIDTH (mm)

(-) = incomplete/ broken

7. THICKNESS (mm)

(-) = incomplete/ broken

8. WEIGHT (g)

9. CROSS SECTION

1. irregular
2. lenticular
3. plano – convex
4. triangular
5. sub – triangular
6. trapezoid
7. parallelogram
8. circular
9. rhomboid
10. pentagonal

10. PLAN FORM/ TOOL TYPE

1. elliptical
2. irregular
3. triangular
4. quadrilateral
5. pentagonal
6. hexahedron
999. indeterminate

11. SIDE A LENGTH (mm) = right distal

999. indeterminate
000. N/A

12. SIDE A: LOCATION OF RETOUCH/ UTILIZATION

1. unimarginal dorsal
2. unimarginal ventral
3. bimarginal (bifacial)
4. combination
999. indeterminate
000. absent

13. SIDE B LENGTH (mm) = left distal

999. indeterminate
000. N/A

14. SIDE B: LOCATION OF RETOUCH/ UTILIZATION

1. unimarginal dorsal
2. unimarginal ventral
3. bimarginal (bifacial)
4. combination
999. indeterminate
000. absent

15. SIDE C LENGTH (mm) = right medial/ lateral proximal

- 999. indeterminate
- 000. N/A

16. SIDE C: LOCATION OF RETOUCH/ UTILIZATION

- 1. unimarginal dorsal
- 2. unimarginal ventral
- 3. bimarginal (bifacial)
- 4. combination
- 999. indeterminate
- 000. absent

17. SIDE D LENGTH (mm) = left medial/ lateral proximal

- 999. indeterminate
- 000. N/A

18. SIDE D: LOCATION OF RETOUCH/ UTILIZATION

- 1. unimarginal dorsal
- 2. unimarginal ventral
- 3. bimarginal (bifacial)
- 4. combination
- 999. indeterminate
- 000. absent

19. SIDE E LENGTH (mm) = right proximal

- 999. indeterminate
- 000. N/A

20. SIDE E: LOCATION OF RETOUCH/ UTILIZATION

- 1. unimarginal dorsal
- 2. unimarginal ventral
- 3. bimarginal (bifacial)
- 4. combination
- 999. indeterminate
- 000. absent

21. SIDE F LENGTH (mm) = left proximal

- 999. indeterminate
- 000. N/A

22. SIDE F: LOCATION OF RETOUCH/ UTILIZATION

- 1. unimarginal dorsal
- 2. unimarginal ventral
- 3. bimarginal (bifacial)
- 4. combination
- 999. indeterminate
- 000. absent

23. % OF CORTEX

- 1. 0
- 2. 1 – 25
- 3. 25 – 50
- 4. 50 – 75
- 5. 75 – 99
- 6. 100%

24. DORSAL SCAR PATTERN

- 1. none – cortical
- 2. irregular
- 3. parallel
- 4. convergent
- 5. radial
- 6. bi – directional (proximal – distal)
- 7. bi – directional (lateral – lateral)

25. PLATFORM THICKNESS (mm)

26. BULBAR THINNING

- 1. absent
- 2. marginal (>75% bulb remaining)
- 3. marginal to semi – invasive (>50% bulb remaining)
- 4. semi – invasive (3/4 bulb removed)
- 5. invasive (bulb completely removed)
- 999. indeterminate
- 000. N/A

27. BIT TYPE

- 1. rounded
- 2. ventral wear
- 3. dorsal wear
- 4. flat
- 5. pecked
- 6. unmodified
- 999. indeterminate
- 000. absent or not present/ broken

28. BIT LENGTH (mm)

29. BIT WIDTH (mm)

30. RETOUCH CLASS

1. unifacial dorsal
2. unifacial ventral
3. partial – bifacial
4. bifacial

31. RETOUCH TYPE

<u>Bifacial</u>	<u>Ventral</u>	<u>Dorsal</u>	
300	100	1	simple
312	112	2	stepped
324	124	3	simple and stepped

32. INVASIVENESS OF RETOUCH

1. absent
2. marginal (<2mm)
3. semi – invasive
4. invasive

33. REJUVINATION/ RETOUCH DISTAL

1. present
2. absent
999. indeterminate

34. ANGLE OF RETOUCH - ∠ LEFT

35. ANGLE OF RETOUCH - ∠ RIGHT

APPENDIX H: ANALYSIS KEY DEFINITIONS

Catalogue #

The *catalogue #*, *C174E/ 3-1a*, references the excavation methodology used for the Caracol Archaeological Project. The *C* stands for the Maya site of Caracol, Belize; *174* refers to the operation or excavation of a defined unit within the site (e.g. house group, architectural feature, specific structure, etc.); the letter *E* is the sub-operation that facilitated multiple, separate excavations on one or more cultural features that are related in some way; the number *3* further separates the sub-operation into smaller arbitrary units of space or *lots* based on excavation strategy and cultural or natural layers present subsurface; *1*, in this example, is the first artifact to be catalogued from *C174E/ 3* and *a* refers to an arbitrary alphabetical system set up for this thesis (after artifact *z*, double (*aa*) and triple (*aaa*) letters are used). Each artifact thus has a unique alpha-numeric label based on its archaeological context that is ever expanding if necessary.

Artifact Type 1 and 2

Artifact Type is a subjective, macro-level assessment based on presence or absence of specific features on each artifact (e.g. lateral retouch, bit morphology, and overall artifact length, width, and thickness). These types are therefore not permanent labels and can be tested against the coded features on each artifact to either confirm or refute the type. In some cases, two artifact types are present.

In this thesis there is no production debris (shell or bone) present by which to add another level of testing. Micro-wear studies were not conducted due to time and availability to resources. Micro-wear would aid in the defining true artifact types and other microscopic features.

Completeness

Completeness is determined based on whether or not the artifact was broken during use-related activities or post-depositional processes. When an artifact had a bulb of percussion or a unbroken proximal end, intact lateral edges, and intact distal tip or bit, it was coded as complete. Other codes, for example, like *proximal- distal* were used if the artifact had an intact proximal end and lateral edges but no distal tip or bit.

Material Color

Material Color is another subjective designation based on the researcher. Due to the heterogeneity of chert deposits, no *Munsell* chart was used. Colors were added when present; therefore, new colors can be added later if necessary. Color can be important from a reduction sequence point-of-view, but in this case should not have any real diagnostic value.

Length, Width, and Thickness

Length, Width, and Thickness was recorded in millimeters (mm) and measured maximum limits of each artifact. Each artifact was held perpendicular then parallel during the measuring process. Measurements were recorded with one electronic digital caliper that measures to the hundredth of a millimeter (0.00mm).

Weight

Weight was measured in grams (g) on one *CL Series, OHAUS* portable digital scale that measured to the tenth of a gram (0.0g).

Cross Section

Cross Section coding was recorded through the approximate middle of the artifact between the proximal and distal ends and then again in the middle between both left and right lateral edges.

Plan Form

Plan Form refers to the general shape of the tool. *Plan Form* is referred to as *Tool Type* in the thesis literature to simplify description (e.g. Type 5 tools are *Plan Form 5* or artifacts with 5 sides). Each artifact does fit into one of these defined shapes. Each plan form was made upon its appearance in the sample and other plan forms may be added in future studies. Each plan form has a defined number of sides and was coded accordingly. For example the number 4 codes for a *quadrilateral* and so forth. Each side was given a letter that is constantly unique and subsequently measured and defined in terms of retouch. For example, *E* always refers to the platform or proximal end with the exception of a hexahedron shape; in most cases, *E* refers to the width of the bulb of percussion on the proximal end of a tool. Quadrilaterals sometimes contain Side *E* because, but most are missing bulbs or the tool has been shaped and the bulb removed. Artifacts were oriented so that the distal portion of the artifact is always down towards the bottom of the page and dorsal surface is up.

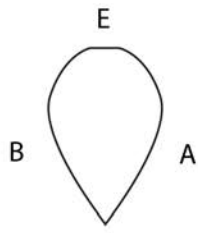

1. Elliptical



2. Irregular

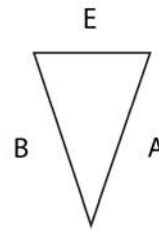

3. Triangular

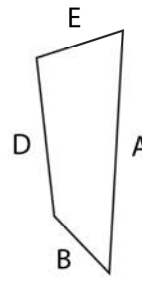
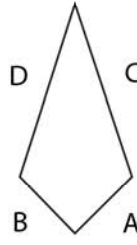
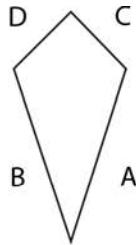

4. Quadrilateral

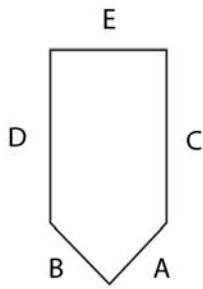

5. Pentagon

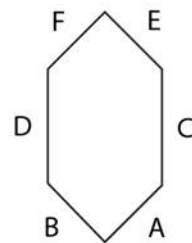
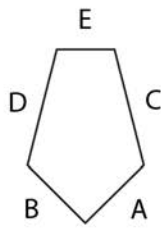

6. Hexahedron

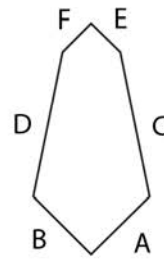

Sides A, B, C, D, E, and F Lengths

The plan form described above pre-defines each side of the artifact. Length measurements were recorded in millimeters. Sides A and B are formed when retouch is intensive enough that the distal end angles to form a bit tip. Sides C and D are either the lateral edges as seen in a pentagonal or hexahedron shape. As stated above, side E is typically the platform or bulb of percussion.

Sides A, B, C, D, E, and F: location of retouch/ utilization

Each side was analyzed to determine location and type of retouch. This methodology subdivides the artifact based on general morphology and specifically assesses the retouch with regard to side. A detailed look at each side focuses attention to both tool manufacture and use.

% of Cortex

Cortex percentage was measured only viewing the dorsal surface of the artifact and was recorded using six ranges (see [Appendix G](#)).

Dorsal Scar Pattern

Dorsal Scar Pattern assessed the *arrises* or the ridges that are formed from the removal of two or more flakes during the reduction process. Dorsal scar patterns can indicate particular reduction sequences and illuminate standards in production or reduction of stone tools. For example artifacts may have parallel or convergent dorsal *arrises* indicating unidirectional core usage.

Platform Thickness

Platform Thickness measures, in millimeters (mm), the bulb of percussion usually on the proximal end of the artifact. This measurement is diagnostic in assessing the reduction sequence of the lithic material. Thick flat platforms found on artifacts are from the reduction of unidirectional cores to make blade-like flakes. These flakes are further retouched to make usable tools. The platform often remains intact during most of the subsequent retouch and is therefore an important feature to record.

Bulbar Thinning

Bulbar Thinning is the partial or complete removal of the bulb of percussion in order to create the desired tool shape. Bulbar thinning has degrees of severity and is recorded accordingly.

Bit Type

Bit Type describes the general morphology of distal end or bit of the tool being studied. A bit may fit into one of the specified categories based on general shape and appearance or location of use wear.

Bit Length

Bit Length is the measurement between the distal extent of the bit and the limit of use wear or the base of the bit formed during the creation of the tool.

Bit Width

The *Bit width* measurement is taken at the base of the bit opposite the distal end of the tool. This measurement marks the maximum width of the bit and therefore records the width of line or hole made by the tool itself.

Retouch Class

Retouch Class is a general descriptor that records the overall modification of the tool. It describes rather the tool was modified on one or more of its surfaces. It does not, however, record the specific location of retouch.

Retouch Type

Retouch Type describes the type of flaking (e.g., pressure flaking) or retouch on an artifact. For example, *stepped* retouch can appear if a tool is shaped not using a pressure flaker and is present when minor step fractures occur during the retouch process during tool manufacture. This usually occurs on the one or more lateral edges.

Invasiveness of Retouch

The *Invasiveness of Retouch* measures the severity of retouch. Was a tool formed by a small or extensive amount of retouch? During the reduction sequence, each flake from a core is reduced to a desired tool shape. Some flakes were modified more extensively than others to form a tool.

Rejuvenation/ retouch distal

Rejuvenation or *Retouch* on the distal end is important for this study as it describes in detail the distal morphology of a tool. *Rejuvenation* records the presence or absence of a flake that was removed, often from the dorsal surface, to re-sharpen a dull bit or form the desired bit morphology. This diagnostic feature was not recorded until it was seen repeatedly. All artifacts were then studied to determine presence or absence of this feature.

Angle of Retouch - \angle Left and Right

All artifacts were measured with a *goniometer* or *protractor* at the midpoint of the artifact to determine edge angle. The ventral surface of the artifact is 0 degrees. Edge angle is useful in determining use based on angle of retouch.

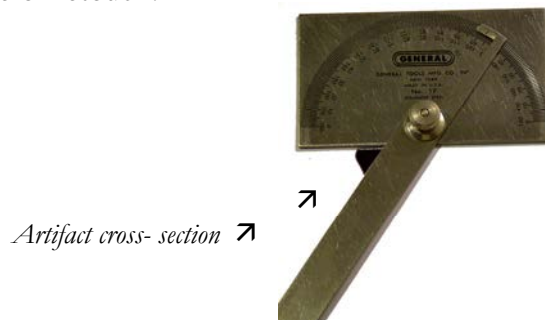

Drawing Conventions

All artifacts were illustrated by the author showing four views: dorsal, ventral, proximal/distal cross-section, and lateral/lateral cross-section. Cross-sections are taken from the respective middle of the artifact. All artifacts are arranged so that the distal portion of the artifact or the bit is towards the bottom of the page. Stippling indicates cortex.

**APPENDIX I: RAW DATA OF CHERT ARTIFACTS FROM
SUBOPERATIONS C174C AND C174E FROM CARACOL, BELIZE 2008**

ID	Cat #	Art. Function 1	Art. Function 2	Comp	Mat Color	L	W	TH	WT	X Sec	Plan Form/ Tool Type	Side A (L)	Side A (rt)	Side B (L)	Side B (rt)	Side C (L)	Side C (rt)	Side D (L)	Side D (rt)	Side E (L)	Side E (rt)	Side F (L)	Side F (rt)	% Cortex	Drs/ Scar Ptn	Pitfm TH	Blb thin	Bit Type	Bit L	Bit W	RT Class	RT Type	Invas RT	Rejuv	Angle RT left	Angle RT right	Comments		
2	C174E/ 3-1a	3		1	1	20.91	10.91	7.2	1.4	4	5	9.31	1	9.31	1	13.39	1	12.15	0	9.37	1	0	0	2	3	999	5	2	1.25	1.72	1	3	3	2	42	50			
3	C174E/ 3-1b	999		999	999	0	0	0	2.3	999	999	0	999	999	999	999	999	999	999	999	999	0	0	999	999	999	999	999	999	999	999	999	999	999	999	999	999	999	broken tool?
4	C174E/ 3-1c	8	999	6	2	-22.17	10.18	5.14	1.6	6	1	-21.52	1	-20.06	1	0	0	0	0	6.18	0	0	0	1	4	3.89	1	6	999	999	1	3	2	999	85	68	tip broken		
5	C174E/ 3-1d	0		999	3	0	0	0	1.5	999	999	0	999	999	999	999	999	999	999	999	999	0	0	999	999	999	999	999	999	999	999	999	999	999	999	999	999	flake	
6	C174E/ 3-1e	3		1	4	21.07	10.15	5.82	1.1	4	5	7.76	1	6.36	3	13.03	0	14.7	0	7.55	0	0	0	3	3	999	1	2	1.58	2.31	3	300	2	1	47	40	cortex +/- 50%, right lateral 100% cortex		
7	C174E/ 3-1f	5		1	3	24.9	13.68	7.97	2.7	6	2	999	1	999	1	0	999	0	0	13.7	0	0	0	1	2	999	6	999	999	999	1	3	3	999	85	65			
8	C174E/ 3-1g	999		6	2	-20.21	11.66	5.89	1.4	6	999	999	999	999	999	-19.81	1	-9.3	1	8.76	0	0	0	1	3	3.98	1	999	999	999	1	3	2	999	72	45	oblique fracture		
9	C174E/ 3-1h	999		6	5	-19.24	9.51	3.88	0.8	4	999	999	999	999	999	-19.24	1	-15.37	1	5.77	0	0	0	1	2	2.65	1	999	999	999	1	3	2	999	65	58	oblique fracture		
10	C174E/ 3-1i	999		4	2	-21.75	10.94	8.56	1.8	4	999	999	999	999	999	999	999	999	999	999	999	0	0	1	2	999	6	999	999	999	1	2	3	999	80	75	angular waste?		
11	C174E/ 3-1j	8	999	1	2	28.89	10.56	6.09	1.3	6	5	8.14	1	6.16	2	13.4	1	15.05	1	10.41	0	0	0	1	3	1.56	1	4	999	999	1	3	2	1	72	80	multipurpose		
12	C174E/ 3-1k	0		999	999	0	0	0	0	999	999	999	999	999	999	999	999	999	999	999	999	999	999	999	999	999	999	999	999	999	999	999	999	999	999	999	999	flake	
13	C174E/ 3-1l	5		6	4	-20.54	13.68	4.64	1.4	1	2	999	1	999	1	0	1	999	1	7.5	0	0	0	1	7	4.14	1	2	1.5	1.66	1	3	3	999	80	80	bec?		
14	C174E/ 3-1m	5		7	6	-18.86	9.94	4.62	1	6	999	5.14	1	6.51	2	-14.77	1	-11.14	1	999	999	0	0	1	4	999	6	999	999	999	3	324	3	1	75	68			
15	C174E/ 3-1n	6		7	6	-21.11	9.24	4.61	1.1	6	1	-18.82	1	-20.1	3	0	0	0	0	999	999	0	0	1	3	999	6	1	1.49	2.41	3	324	3	1	70	98			
16	C174E/ 3-1o	1	2	1	2	18.57	8.2	4.09	0.6	6	5	5.15	1	5.32	3	14.18	1	15.97	1	5.11	0	0	0	1	3	2.39	999	1	1.2	1.68	3	324	3	1	67	62			
17	C174E/ 3-1p	1	7	1	4	19.54	8.71	5.38	1	6	1	18.72	1	19.41	3	0	0	0	0	3.21	0	0	0	1	4	2.49	1	1	2.07	2.51	3	324	3	1	67	56			
18	C174E/ 3-1q	6		1	4	16.87	7.29	6.72	0.8	4	5	5.01	1	7.06	3	12.83	1	8.47	1	6.82	1	0	0	1	3	1.06	1	1	1.22	2.22	3	324	2	1	66	78			
19	C174E/ 3-1r	999		6	7	-21.37	9.84	4.72	1.2	6	5	-6.6	999	-6.01	1	-14.55	1	15.74	1	7.43	0	0	0	1	3	1.99	1	999	999	999	1	3	3	999	76	65	poss. scraper		
20	C174E/ 3-1s	1	3	1	4	14.07	10.31	4.6	0.6	4	5	5.06	1	7.25	1	8.39	1	6.42	1	8.06	0	0	0	1	2	4.6	1	1	1.89	1.63	1	2	2	2	78	72			
21	C174E/ 3-1t	6		1	2	16.85	9.98	4.38	0.9	6	5	6.15	1	7.45	3	12.12	1	10.48	1	6.59	0	0	0	1	3	4.38	1	1	1.03	999	3	324	3	1	65	68	take another look?		
22	C174E/ 3-1u	8	999	1	6	21.04	10.58	7.02	1.8	6	5	7.99	1	8.55	3	12.79	1	9.34	1	9.64	0	0	0	1	3	2.65	1	4	999	999	3	324	3	1	65	67			
23	C174E/ 3-1v	2	999	6	4	-21.47	11.29	4.13	1.3	6	999	999	999	999	999	-19.72	1	-21.51	1	6.47	0	0	0	1	4	2.24	1	999	999	999	1	3	3	999	68	64			
24	C174E/ 3-1w	4	6	7	1	-18.53	-9.74	5.11	0.9	3	999	9.9	3	8.58	3	-5.72	1	-10.17	1	999	999	0	0	1	3	999	6	1	1.47	1.95	3	324	4	1	72	79	oblique break, sides A and B bimarginal and combo retouch		

ID	Cat #	Art. Function 1	Art. Function 2	Comp	Mat Color	L	W	TH	WT	X Sec	Plan Form/ Tool Type	Side A (L)	Side A (rt)	Side B (L)	Side B (rt)	Side C (L)	Side C (rt)	Side D (L)	Side D (rt)	Side E (L)	Side E (rt)	Side F (L)	Side F (rt)	% Cortex	Drsl Scar Ptn	Pltfm TH	Bib thin	Bit Type	Bit L	Bit W	RT Class	RT Type	Invas RT	Rejuv	Angle RT left	Angle RT right	Comments
25	C174E/ 3-1x	6	999	4	6	-14.21	-8.63	4.69	0.8	6	5	-5.96	1	-3.72	3	-10.02	1	-10.77	1	-8.17	999	0	0	1	3	999	6	5	999	2.11	3	324	3	1	63	63	
26	C174E/ 3-1y	7		6	4	16.74	12.22	4.74	1.3	6	5	4.7	1	6.78	3	12.49	1	10.24	1	9.3	1	0	0	1	999	0.6	2	5	0.86	1.7	3	324	3	1	999	999	angular waste?
27	C174E/ 3-1z	1	3	7	7	-16.03	-8.87	4.01	0.7	7	999	3.9	3	6.08	3	-10.07	0	-10.71	1	999	999	0	0	4	4	999	6	1	1.12	1.92	3	324	3	999	60	98	edge angle problematic
28	C174E/ 3-1aa	6		1	1	18.48	11.16	3.92	0.9	6	3	17.71	1	17.44	3	0	0	0	10.9	1	0	0	1	4	999	5	1	1.09	1.38	3	324	3	1	58	60	similar to C174E/ 3-1a	
29	C174E/ 3-1bb	8		4	6	17.24	8.85	5.7	1.1	6	5	6.4	1	6.08	3	10.33	1	12.23	1	8.6	1	0	0	1	3	999	5	4	999	999	3	324	3	1	68	65	tip absent but rejuv present
30	C174E/ 3-1cc	6	1	1	6	18.29	9.2	3.71	0.6	6	6	4.65	1	4.1	3	9.64	1	12.3	1	5.93	0	6.83	0	1	4	999	1	1	1.38	1.72	3	324	3	1	64	50	spiral distal bit with rejuv flake
31	C174E/ 3-1dd	3	5	7	4	-21.48	-8.57	5.19	0.8	6	1	-21.47	1	-12.72	1	0	0	0	0	0	0	0	0	1	4	999	6	1	1.49	1.21	1	3	4	2	71	72	
32	C174E/ 3-1ee	6		1	6	16.9	9.32	3.44	0.5	3	5	6.43	1	15.45	3	12.94	1	12.24	1	7.58	0	0	0	1	2	0.62	1	1	1.32	1.73	3	324	3	1	52	63	spiral distal bit with rejuv flake
33	C174E/ 3-1ff	6	3	1	7	17.1	8.97	4.98	0.9	10	5	5.33	1	10.55	3	11.04	1	5.38	1	8.03	0	0	0	1	2	8.03	6	1	1	1.79	3	324	3	1	65	80	two oblique fractures
34	C174E/ 3-1gg	6		7	6	16.48	8.12	4	0.6	6	5	4.17	1	6.06	3	-10.72	0	-11.19	1	-7.76	999	0	0	1	4	999	6	1	1.7	1.8	3	324	3	1	51	54	two oblique fractures
35	C174E/ 3-1hh	6		7	2	16.25	9.51	3.8	0.7	6	5	5.08	1	4.94	3	-8.97	1	-12.81	1	8.55	999	0	0	1	4	999	6	1	1.33	1.58	3	324	3	1	64	57	two oblique fractures
36	C174E/ 3-1ii	6		1	4	14.77	7.25	2.69	0.4	6	5	3.4	1	4.2	3	10.93	0	11.92	1	6.59	999	0	0	1	4	999	6	1	1.2	1.56	3	324	2	1	63	54	platform removed intentionally?
37	C174E/ 3-1jj	6		1	1	16.77	8.21	6.58	0.8	4	5	4.85	1	3.15	1	13.68	1	12.6	1	6.9	0	0	0	2	3	2.59	1	3	0.72	1.02	1	1	2	2	83	45	
38	C174E/ 3-1kk	2	999	6	6	11.05	10.42	3.66	0.4	4	999	999	999	999	999	-8.47	1	-12.06	1	4.16	0	0	0	1	3	999	1	999	999	999	2	3	2	999	61	57	
39	C174E/ 3-1ll	6		1	6	17.55	9.95	4.17	0.7	6	5	6.89	1	5.53	3	12.34	1	13.34	1	10.17	0	0	0	1	4	3.99	1	1	1.24	1.44	3	324	3	1	70	57	
40	C174E/ 3-1mm	6		1	6	17.16	9.33	4.45	1	6	5	5.5	1	6.18	2	14.75	1	10.45	1	4.59	0	0	0	2	2	1.73	1	1	1.11	2.25	3	324	3	1	82	90	
41	C174E/ 3-1nn	6		1	4	15.45	7.5	3.75	0.6	6	5	5.98	3	6.87	3	8.1	1	9.5	1	6.1	0	0	0	1	3	2.01	1	2	1.14	2.14	3	324	3	2	65	83	
42	C174E/ 3-1oo	6		1	7	12.37	8.03	5.12	0.5	6	5	5.25	1	5.59	3	6.82	1	6.13	1	7.72	0	0	0	2	3	4.71	1	5	1.09	1.65	3	324	3	1	60	52	
43	C174E/ 3-1pp	6		7	2	-16.36	8.44	6.57	0.9	4	5	5.34	1	5.29	3	-11.96	0	-11.67	1	7.24	0	0	0	1	3	999	999	1	1.25	1.65	3	324	3	1	60	58	
44	C174E/ 3-1qq	6	999	4	6	-12.58	8.6	4.14	0.6	10	5	-4.11	1	-4.2	3	-9.25	1	-7.79	1	8.08	0	0	0	1	3	999	999	999	999	999	3	324	3	1	79	67	
45	C174E/ 3-1rr	6		7	4	-18.32	-8.25	4.33	0.6	3	5	5.25	1	6.02	1	-7.27	1	-12.6	1	999	999	0	0	1	4	999	999	1	1.23	1.98	1	3	3	2	70	69	
46	C174E/ 3-1ss	6	999	6	6	-23.44	9.69	4.44	1.1	6	5	-9.59	1	-5.67	2	12.33	1	15.31	1	8.11	0	0	0	1	3	0.61	1	999	999	999	3	324	3	1	89	66	
47	C174E/ 3-1tt	6		1	1	16.77	7.59	4.13	0.6	6	5	3.05	1	5.74	3	12.79	1	10.65	1	5.13	0	0	0	2	1	1.12	1	1	0.73	1.3	3	324	3	1	57	71	
48	C174E/ 3-1uu	6		1	7	18.26	9.52	3.36	0.6	6	5	6.28	1	5.69	1	13.41	1	13.77	1	8.33	0	0	0	1	3	2.29	1	1	1.07	2.12	1	3	3	2	63	68	

ID	Cat #	Art. Function 1	Art. Function 2	Comp	Mat Color	L	W	TH	WT	X Sec	Plan Form/ Tool Type	Side A (L)	Side A (rt)	Side B (L)	Side B (rt)	Side C (L)	Side C (rt)	Side D (L)	Side D (rt)	Side E (L)	Side E (rt)	Side F (L)	Side F (rt)	% Cortex	Drsl Scar Ptn	Pltfm TH	Bib thin	Bit Type	Bit L	Bit W	RT Class	RT Type	Invas RT	Rejuv	Angle RT left	Angle RT right	Comments	
49	C174E/ 3-1vv	6		1	5	16.26	6.71	3.22	0.3	6	5	3.56	1	3.89	3	12.33	1	13.97	1	5.03	0	0	0	2	3	2.33	1	1	0.87	1.89	3	324	3	1	65	41		
50	C174E/ 3-1ww	4		5	1	12.04	-6.58	-4.67	0.2	5	999	-12.17	1	-8.83	1	999	999	999	999	999	999	0	0	2	3	999	999	1	1.46	2	3	324	3	2	999	999		
51	C174E/ 3-1xx	0		999	999	0	0	0	0.3	999	999	999	999	999	999	999	999	999	999	999	999	999	999	999	999	999	999	999	999	999	999	999	999	999	999	999	999	flake
52	C174E/ 3-1yy	6		1	2	17.42	8.81	5.59	0.8	6	5	5.36	1	5.34	3	11.74	1	12.01	1	8.68	1	0	0	1	4	999	5	1	0.71	1.08	3	324	3	1	75	70		
53	C174E/ 3-1zz	6		1	2	13.74	8.32	3.34	0.4	6	5	4	1	4.92	3	8.35	1	9.81	1	7.91	0	0	0	1	4	2.4	1	1	1.1	1.89	3	324	3	1	55	58		
54	C174E/ 3-1aaa	5		1	6	17.98	7.72	3	0.4	6	5	5.47	1	4.36	2	13.83	1	12.99	1	5.12	0	0	0	1	3	2.16	1	2	1	1.81	3	324	3	1	68	68	minor use wear related?	
55	C174E/ 3-1bbb	6		1	4	13.81	6.02	4.66	0.4	4	5	3.58	1	4.86	2	10.83	1	10.2	1	5.47	2	0	0	1	3	999	5	1	0.95	1.53	3	324	3	1	60	73	good example	
56	C174E/ 3-1ccc	6		7	4	12.31	7.85	2.97	0.4	6	5	5.12	1	3.34	1	-9.25	1	-9.25	1	6.24	0	0	0	1	3	999	999	999	999	999	1	3	3	2	73	74	broken blank. tip seems unmodified	
57	C174E/ 3-1ddd	6		1	2	19.03	8.59	3.7	0.6	1	5	7.55	1	9.48	1	12.36	1	6.39	1	7.2	0	0	0	1	2	999	999	1	1.83	2.01	1	3	3	2	78	78		
58	C174E/ 3-1eee	5		1	1	17.72	8.91	3.97	0.6	6	5	5.67	1	4.78	2	14.61	1	12.41	1	5.9	0	0	0	1	4	1.89	1	3	0.86	1.19	3	324	3	1	75	74		
59	C174E/ 3-1fff	5		4	2	16.59	6.3	4.75	0.4	4	3	-14.07	1	-13.62	1	0	0	0	0	999	999	999	0	2	3	999	999	999	999	999	1	3	3	999	58	58		
60	C174E/ 3-1ggg	6		1	5	21.01	8.28	5.89	0.9	4	5	2.19	1	6.2	2	19.69	1	15.88	1	2.36	0	0	0	4	3	2.2	1	6	999	999	3	324	3	1	75	88	poss. blank. distal end is shaped, but not used like others (see C174E/ 3-1bbb).	
61	C174E/ 3-1hhh	6		1	4	14.5	7.49	3.77	0.4	6	5	11.36	1	8.39	3	4.5	1	5.5	1	5.13	0	0	0	1	4	3.96	1	1	1.37	1.93	3	324	4	1	73	50		
62	C174E/ 3-1iii	6		1	6	18.12	8.77	3.3	0.6	4	5	6.52	1	4.36	3	13.61	1	14.06	1	4.88	0	0	0	1	2	0.78	1	1	1.04	2.43	3	324	4	1	59	65		
63	C174E/ 3-1jjj	6		4	2	-15	6.55	3.65	0.3	4	5	-5.52	1	-5.81	1	-9.12	1	-10.26	0	6.16	999	0	0	1	3	999	999	999	999	2.54	1	3	3	2	75	74		
64	C174E/ 3-1kkk	4		5	6	-13.46	-3.47	-3.96	0.2	6	999	-11.66	1	-13.34	1	999	999	999	999	999	999	0	0	1	2	999	999	1	2.42	2.33	1	3	4	2	999	999	just a tip	
65	C174E/ 3-1lll	5		5	6	-10.85	-6.32	-2.68	0.2	6	999	-10.64	1	-12.32	1	999	999	999	999	999	999	0	0	1	3	999	999	999	1.68	1.46	1	3	3	2	72	75	just a tip	
66	C174E/ 3-1mmm	0		999	999	0	0	0	0.4	999	999	999	999	999	999	999	999	999	999	999	999	999	999	999	999	999	999	999	999	999	999	999	999	999	999	999	999	flake
67	C174E/ 3-1nnn	6		6	2	-20.25	7.74	3.69	0.6	6	5	-15.97	1	-17.95	1	6.25	0	4.12	0	0	0	0	0	1	3	1.21	1	999	999	2.2	1	3	3	2	67	69		
68	C174E/ 3-1ooo	6		6	6	-16.43	8.07	2.61	0.4	6	5	-6.19	1	-3.48	1	9.84	1	13	1	5.69	0	0	0	1	2	1.06	1	999	999	2.54	1	3	3	2	65	70		
69	C174E/ 3-1ppp	6		1	2	18.08	8.33	2.58	0.3	6	5	5.5	1	5.17	3	13.47	1	12.79	1	6.5	0	0	0	1	3	0.86	1	1	1.12	2.13	3	324	3	1	65	65		
70	C174E/ 3-2a	6		1	2	36.11	16.22	9.89	6.9	6	5	16.02	4	16.99	4	22.69	1	18.55	1	21.38	0	0	0	1	3	7.02	1	1	3.79	5.55	3	324	3	1	75	77	distal end is bifacial on left and right sides	

ID	Cat #	Art. Function 1	Art. Function 2	Comp	Mat Color	L	W	TH	WT	X Sec	Plan Form/ Tool Type	Side A (L)	Side A (rt)	Side B (L)	Side B (rt)	Side C (L)	Side C (rt)	Side D (L)	Side D (rt)	Side E (L)	Side E (rt)	Side F (L)	Side F (rt)	% Cortex	Drsl Scar Ptn	Pltfm TH	Bib thin	Bit Type	Bit L	Bit W	RT Class	RT Type	Invas RT	Rejuv	Angle RT left	Angle RT right	Comments
71	C174E/ 3-2b	6		1	8	27.78	13.7	6.3	2.6	10	3	23.68	1	26.28	4	0	0	0	0	14.06	999	0	0	1	4	3.37	6	1	3.57	4.85	3	324	3	1	80	91	
72	C174E/ 3-2c	6		1	2	31.64	13.5	7.69	3.6	6	5	15.82	1	9.58	2	16.57	1	23.47	1	9.81	0	0	0	1	2	3.21	1	1	2.18	3.72	3	324	3	1	69	76	
73	C174E/ 3-2d	6		1	6	20.58	10.64	5.61	1.3	6	5	8.32	1	6.73	2	9.44	1	13.51	1	9.88	1	0	0	1	2	2.76	1	1	3.31	2.7	3	324	3	1	65	84	side D includes the platform and measures 6.92mm
74	C174E/ 3-2e	6		6	6	-25.38	11.17	7.14	2.6	6	5	-11.75	1	-8.98	1	13.36	1	11.28	0	7.74	0	0	0	1	4	4.38	999	999	999	999	1	3	3	2	84	80	tip broken
75	C174E/ 3-2f	6	999	6	5	-21.8	9.48	6.48	1.6	6	5	999	999	-4.19	1	19.9	1	16.31	1	8.83	0	0	0	5	2	999	999	0	999	999	1	3	2	999	74	78	tip broken
76	C174E/ 3-2g	2		1	5	21.93	9.17	8.31	1.9	4	4	0	0	0	0	15.9	1	0	0	0	0	0	0	5	7	999	999	999	999	999	1	1	3	999	0	85	scrapper
77	C174E/ 3-2h	6		1	4	17.82	8.95	6.51	1	6	5	5.1	1	6.16	2	12.73	1	12.31	1	5.63	999	0	0	1	3	3.38	1	1	2	2.57	3	324	4	1	74	64	angular waste flake to drill
78	C174E/ 3-2i	6		1	2	23.62	7.33	9.9	1.6	4	1	6.86	1	6.53	2	18.82	1	18.91	1	0	0	0	0	2	3	999	999	1	2.68	3.44	3	3	3	1	72	75	
79	C174E/ 3-2j	999		6	2	28.91	12.53	6.61	2.5	6	999	999	999	999	999	-22.23	1	-27.67	1	8.19	1	0	0	1	2	999	999	0	999	999	1	3	3	999	83	82	
80	C174E/ 3-2k	3	999	6	4	-24.84	10.05	8.26	1.8	4	5	-11.26	1	-5.24	2	13.87	1	20.71	1	5.84	0	0	0	1	3	4.9	1	999	999	999	3	3	2	1	63	50	long bit, but absent
81	C174E/ 3-2l	6		6	2	-20.37	10.56	6.43	1.5	6	3	-19.75	1	-16.35	4	0	0	0	0	10.68	0	0	0	1	4	3.03	1	999	999	999	3	324	3	1	73	54	tip broken
82	C174E/ 3-2m	6		6	6	-17.49	9.68	6.23	0.9	2	5	-4.75	1	-3.79	3	8.31	0	11.71	1	9.68	0	0	0	1	2	999	999	999	999	999	3	324	3	1	73	57	tip broken
83	C174E/ 3-2n	8		1	4	16.97	9.07	5.21	1	6	4	999	0	0	0	10.51	1	14.9	0	7.67	0	0	0	1	2	999	1	999	999	999	1	2	2	1	41	77	possible blank
84	C174E/ 3-2o	6		1	6	20.71	10.05	5.72	1.4	6	5	7.7	1	6.46	2	11.95	1	15.35	1	7.55	0	0	0	1	4	5.52	1	1	1.91	2.94	3	324	3	1	60	68	
85	C174E/ 3-2p	999	7	6	2	-20.78	8.95	8.44	1.5	4	5	-7.43	1	-9.71	2	12.31	0	12.7	0	7.07	1	0	0	2	3	999	5	999	999	999	3	324	2	1	77	60	tip missing
86	C174E/ 3-2q	6		1	1	21.32	11.03	6.61	1.6	6	5	8.18	1	8.2	2	12.62	0	15.21	1	5.53	0	0	0	2	3	6.3	1	1	1.57	2.62	3	324	2	1	65	80	cortex on right lateral edge
87	C174E/ 3-2r	6		6	1	-24.54	10.88	9.5	2.2	6	5	-9.06	2	-6.93	2	16.93	1	18.65	4	4.19	0	0	0	2	4	999	999	999	999	999	3	324	3	1	74	79	tip missing
88	C174E/ 3-2s	6		6	4	-17.04	9.2	6.01	1.1	6	5	-5.89	1	-1.43	1	10.2	1	13.97	1	8.58	0	0	0	1	3	4.1	1	999	999	999	1	3	2	999	65	75	tip missing
89	C174E/ 3-2t	5		1	2	18.87	9.66	5.12	1	6	5	5.02	1	8.73	2	13.4	1	11.45	1	8.93	0	0	0	1	3	4.16	1	2	999	999	3	324	3	1	71	76	very nice example
90	C174E/ 3-2u	5		1	2	22.6	10.2	6.48	1.7	6	5	6.51	1	9.47	2	16.97	1	14.31	1	7.81	0	0	0	1	3	5.1	1	2	999	999	3	324	3	1	76	64	incisor
91	C174E/ 3-2v	5		1	4	22.32	8	5.57	1.1	6	5	3.95	1	4.37	2	18.03	0	17.67	1	4.71	0	0	0	3	3	999	999	2	999	999	3	324	2	1	60	58	incisor
92	C174E/ 3-2w	6		1	6	19.72	10.04	7.47	1.4	4	5	5.4	1	5.03	2	14.65	1	15.94	1	6.83	0	0	0	2	3	999	999	1	2.06	2.31	3	324	3	1	51	58	inclusions
93	C174E/ 3-2x	6		6	1	-20.33	9.56	6.79	1.2	4	6	-5.99	3	-7.43	3	6.44	2	6.58	1	10.05	2	6.91	3	1	3	999	999	999	999	2.2	3	324	4	1	70	52	double ended tool
94	C174E/ 3-2y	6		6	5	-20.91	8.8	5.72	1	6	5	-7.85	1	-6.37	2	15.09	1	15.46	1	9.24	0	0	0	1	4	999	999	999	999	999	3	324	3	1	73	67	

ID	Cat #	Art. Function 1	Art. Function 2	Comp	Mat Color	L	W	TH	WT	X Sec	Plan Form/ Tool Type	Side A (L)	Side A (rt)	Side B (L)	Side B (rt)	Side C (L)	Side C (rt)	Side D (L)	Side D (rt)	Side E (L)	Side E (rt)	Side F (L)	Side F (rt)	% Cortex	DrsI Scar Prn	Pltfm TH	Bib thin	Bit Type	Bit L	Bit W	RT Class	RT Type	Invas RT	Rejuv	Angle RT left	Angle RT right	Comments
95	C174E/ 3-2z	6		1	3	16	9.04	5.5	0.8	6	5	7.65	3	5.61	3	9.15	1	10.37	1	7.04	0	0	0	2	3	4.98	1	1	1.96	2.47	3	324	3	1	70	78	chisel- step fractures at distal end
96	C174E/ 3-2aa	6		1	2	18.27	7.5	3.5	0.5	6	5	6.84	1	6.43	2	14.2	1	11.52	1	4.98	0	0	0	1	3	999	999	1	2.18	2.93	3	324	3	1	73	60	
97	C174E/ 3-2bb	6		6	2	-19.84	9.25	5.53	1.3	3	5	-7.88	3	-9.68	2	11.86	1	12.35	1	8.37	0	0	0	1	2	4.41	1	999	999	999	3	324	3	1	76	73	
98	C174E/ 3-2cc	6		6	2	-19.01	10.08	7.22	1.1	4	5	-4.94	1	-6.34	2	15.29	1	7.42	1	8.27	0	0	0	1	3	1.76	999	999	999	999	3	324	3	1	72	72	
99	C174E/ 3-2dd	6		1	1	16.25	8.09	5.97	0.8	6	3	13.46	1	19.56	4	0	0	0	0	10.25	0	0	0	1	2	2	999	1	1.42	2.18	3	324	4	1	87	75	unusual plan form- maybe post depositional damage
100	C174E/ 3-2ee	2	999	4	6	-16.91	-8.74	4.55	0.8	6	999	0	0	0	0	-16.31	1	-13.48	1	0	0	0	0	1	4	999	999	999	999	999	1	3	3	999	74	96	
101	C174E/ 3-2ff	2	999	3	2	-11.59	-9.78	4.31	0.6	3	999	0	0	0	0	-11.47	1	-11.63	1	6.5	0	0	0	1	2	3.02	1	999	999	999	1	3	2	999	78	78	broken
102	C174E/ 3-2gg	6		1	2	19.36	10.56	5.03	1.1	6	5	4.91	3	4.7	3	14.61	1	11.31	1	9.74	1	0	0	1	2	999	999	1	1.19	1.68	3	324	3	999	73	65	bifacially flaked distal end
103	C174E/ 3-4a	2	999	7	2	-34.35	17.73	8.56	5.4	6	3	-30.63	1	-34.37	1	0	0	0	0	14.26	0	0	0	1	4	3.9	1	999	999	999	1	3	3	999	71	81	
104	C174E/ 3-4b	5		6	5	-25.43	10.02	6.47	1.9	6	4	10.96	1	25.02	1	-15.97	1	-9.73	0	0	0	0	0	4	2	999	999	2	999	999	1	3	3	2	75	85	
105	C174E/ 3-4c	6		1	6	23.53	10.51	7.09	2.1	6	5	8.7	1	6.96	2	15.09	1	16.53	1	8.27	0	0	0	1	4	5.42	1	1	2.89	3.39	3	324	3	1	80	82	
106	C174E/ 3-4d	6		7	6	15.81	6.97	3.57	0.4	6	5	6.05	1	5.7	1	9.67	0	8.53	1	6.17	2	0	0	1	3	0.72	4	1	2.52	2.75	3	3	3	2	77	48	
107	C174E/ 3-4e	6		1	7	20.48	10.74	5.65	1.5	10	5	7.47	1	8.99	2	14.16	1	12.04	1	9.68	0	0	0	4	1	2.67	1	1	2.48	2.01	3	324	3	1	83	73	
108	C174E/ 3-4f	5		1	4	17.24	9.07	2.82	0.5	6	5	6.12	1	6.56	1	10.66	1	10.32	1	9.03	1	0	0	1	4	999	5	999	999	999	1	3	4	2	70	68	
109	C174E/ 3-4g	6		1	6	18.12	8.23	4.22	1	6	5	8.38	1	5.05	3	11.51	1	12.65	1	8.08	0	0	0	1	4	999	5	1	1.97	2.34	3	324	3	1	78	85	
110	C174E/ 3-4h	5	7	1	6	21.77	9.3	6.1	1.4	6	5	7	1	7.39	1	17.37	1	12.41	1	7.34	0	0	0	1	2	999	5	1	1.33	3.46	1	3	3	2	76	73	
111	C174E/ 3-4i	6		1	1	16.95	8.96	4.79	0.9	6	5	6.47	1	7.02	3	11.5	1	10.52	1	8.55	0	0	0	1	3	999	999	999	999	999	3	324	3	1	87	88	rejuv flake minor, maybe use related nor intentionally removed
112	C174E/ 3-4j	6		1	6	14.45	7.66	2.74	0.4	6	5	5.39	1	5.94	1	10.62	1	9.43	1	7.48	0	0	0	1	4	999	999	1	1.82	2.88	3	3	3	2	73	65	
113	C174E/ 3-4k	6		6	6	-15	9.77	4.9	0.9	6	5	-6.83	1	-7.75	3	10.05	1	9.17	1	9.61	0	0	0	1	3	3.81	1	999	999	2.89	3	324	2	1	74	60	
115	C174E/ 3-4l	6	7	1	6	33.3	16.68	8.93	5.1	3	3	31.49	1	32.72	1	0	0	0	0	14.23	0	0	0	1	4	5.64	1	999	999	3.56	1	3	4	2	73	66	
116	C174E/ 3-4m	6		1	9	31.37	12.82	7.71	3.5	6	5	11.45	1	9.06	3	20.94	1	25.53	1	9.21	0	0	0	2	3	5.71	1	999	1.7	2.47	3	324	3	1	75	95	
117	C174E/ 3-4n	6		1	4	16.32	11.52	6.67	1.6	3	5	6.25	1	7.48	2	12.02	1	11.18	1	9.7	0	0	0	1	6	4.8	1	1	1.44	3	3	324	4	1	69	73	

ID	Cat #	Art. Function 1	Art. Function 2	Comp	Mat Color	L	W	TH	WT	X Sec	Plan Form/ Tool Type	Side A (L)	Side A (rt)	Side B (L)	Side B (rt)	Side C (L)	Side C (rt)	Side D (L)	Side D (rt)	Side E (L)	Side E (rt)	Side F (L)	Side F (rt)	% Cortex	Drsl Scar Prn	Pltfm TH	Bib thin	Bit Type	Bit L	Bit W	RT Class	RT Type	Invas RT	Rejuv	Angle RT left	Angle RT right	Comments	
118	C174E/ 3-4o	6		6	2	-34.86	13.86	8.64	3.9	6	5	-26.46	1	-27.19	1	9.12	1	9.88	1	3.85	0	0	0	2	3	1.55	1	999	999	3.27	1	2	4	999	96	90		
119	C174E/ 3-4p	5		1	6	15.84	5.87	2.8	0.3	6	2	16.11	1	15.73	1	0	0	0	0	5.91	0	0	0	1	3	999	6	999	999	2.91	1	2	2	2	72	67	prox end snapped	
120	C174E/ 3-4q	6	5	1	6	15.16	7.59	3.03	0.4	6	5	5.36	1	5.25	2	10.61	1	10.62	1	5.42	0	0	0	1	3	999	5	1	1.59	1.51	3	324	2	1	73	73	prox end snapped	
121	C174E/ 3-4r	6		1	7	16.31	8.97	4.27	0.9	3	5	4.49	1	5.54	2	13.27	1	12.32	1	6.73	0	0	0	1	4	2.77	1	1	1.2	2.3	3	324	4	1	70	80		
122	C174E/ 3-4s	6	5	1	4	18.22	9.95	5.67	1.4	3	5	7.34	1	5.13	3	10.8	1	14.24	1	7.76	0	0	0	1	2	3.32	1	3	1.61	2.08	3	324	3	1	80	68		
123	C174E/ 3-4t	2	999	4	6	-12.28	-6.49	-3.55	0.4	10	3	-12.39	1	-11.85	1	999	999	999	999	-6.45	0	0	0	1	3	999	6	999	999	999	1	3	3	999	77	70		
124	C174E/ 3-4u	6	5	1	6	15.22	7.22	3.67	0.5	6	5	6.3	1	5.39	2	7.49	1	10.42	1	7.53	0	0	0	1	4	999	999	1	1.67	2.47	3	324	4	1	73	63	prox end snapped	
125	C174E/ 3-4v	6		1	2	21.44	10	5.87	1.3	3	5	7.6	1	7.49	2	14.96	1	14.52	1	6.02	0	0	0	1	2	4.14	1	1	1.54	2.36	3	324	4	1	80	71		
126	C174E/ 3-4w	6	5	1	4	14.63	7.63	2.71	0.3	6	5	4.36	1	4.59	3	10.18	1	11.88	1	5.94	1	0	0	1	4	999	5	1	1.57	2.11	3	324	4	1	72	50		
127	C174E/ 3-4x	6	5	1	6	18.23	9.92	4.66	1	6	5	6.76	1	7.74	2	11.46	1	13.36	1	8.81	2	0	0	1	3	-3.96	5	1	1.5	2.29	3	324	3	1	76	65		
128	C174E/ 3-4y	5	7	1	2	25.15	12.25	6.62	2.2	6	5	9.26	1	8.21	2	19.15	1	14.77	1	9.68	0	0	0	1	3	2.18	1	3	0.76	1.45	3	324	3	1	74	81		
129	C174E/ 3-4z	6		1	6	21.05	9.95	5.72	1.1	6	5	6.21	1	6.14	3	15.26	1	12.45	1	9.96	0	0	0	1	4	999	999	1	1.73	2.71	3	324	3	1	82	85		
130	C174E/ 3-4aa	6		1	2	20.55	10.36	6.45	1.5	6	5	6.65	1	8.43	3	13.29	1	14.84	1	6.29	0	0	0	1	3	2.91	1	1	1.66	2.5	3	324	3	1	75	71		
131	C174E/ 3-4bb	6		6	7	-15.34	6.78	4.12	0.5	6	5	-5.33	1	-4.21	2	10.03	1	11.15	1	6.15	0	0	0	1	4	2.85	1	0	999	999	3	324	3	1	64	51		
132	C174E/ 3-4cc	6	7	1	6	19.82	11.1	6.72	1.5	10	5	4.79	1	9.69	2	16.82	1	9.68	1	7.84	0	0	0	1	3	6.01	1	1	999	999	3	324	3	1	83	72		
133	C174E/ 3-4dd	5		1	4	16.89	11.92	5.28	1.1	6	5	4.6	1	2.31	2	14.97	1	13.84	1	11.21	0	0	0	1	2	999	999	6	0.88	1.64	3	324	4	1	73	78		
134	C174E/ 3-4ee	6		1	6	23.1	11.02	5.63	1.5	10	5	7.67	1	9.25	2	15.49	1	16.79	1	6.33	0	0	0	1	3	5.86	1	1	1.6	3.05	3	324	4	1	65	67		
135	C174E/ 3-4ff	8	6	1	6	18.54	8.37	4.29	0.7	10	5	4.87	1	6.62	2	13.57	1	12.98	1	7.48	0	0	0	1	4	1.71	1	6	999	999	3	324	3	1	84	80		
136	C174E/ 3-4gg	6		1	2	20.42	8.68	4.22	0.9	6	5	5.95	1	4.02	2	17.17	1	15.41	1	6.6	0	0	0	1	4	1.28	1	1	0.75	1.75	3	324	3	1	64	78		
137	C174E/ 3-4hh	4	0	6	4	-19.84	6.26	3.36	0.3	4	999	999	999	999	999	999	999	999	999	3.8	0	0	0	1	4	2.75	1	999	999	999	999	999	999	999	999	999	999	burin/ awl ?
138	C174E/ 3-4ii	8	6	1	4	20.72	8.7	5.58	1.1	6	5	6.72	1	2.17	2	14.86	1	17.42	1	6.11	0	0	0	1	3	2.32	1	6	999	999	3	324	3	1	84	82		
139	C174E/ 3-4jj	6		1	6	14.31	8.98	5.53	0.8	6	5	6.92	1	4.52	2	8.12	1	11.16	1	7.16	0	0	0	1	4	3.66	1	1	1.1	2.29	3	324	3	1	68	74		
140	C174E/ 3-4kk	4	999	6	2	-18.83	9.67	4.05	0.6	4	3	-14.47	1	-15.38	1	0	0	0	0	9.59	0	0	0	1	7	1.29	1	999	999	999	1	3	4	999	60	65	burin/ awl?	
141	C174E/ 3-4ll	3		1	6	15.23	6.97	3.14	0.3	6	5	4.68	3	3.97	1	10	1	12.93	1	5.95	0	0	0	1	4	1.87	1	1	999	999	3	324	3	1	60	70		
142	C174E/ 3-4mm	5		1	6	15.23	8.85	2.94	0.3	6	5	6.31	1	5.36	1	10.07	1	7.62	1	7.1	0	0	0	1	4	1.08	1	1	1.4	2.18	1	3	3	999	60	55		

ID	Cat #	Art. Function 1	Art. Function 2	Comp	Mat Color	L	W	TH	WT	X Sec	Plan Form/ Tool Type	Side A (L)	Side A (rt)	Side B (L)	Side B (rt)	Side C (L)	Side C (rt)	Side D (L)	Side D (rt)	Side E (L)	Side E (rt)	Side F (L)	Side F (rt)	% Cortex	Drsl Scar Prn	Pflfm TH	Bib thin	Bit Type	Bit L	Bit W	RT Class	RT Type	Invas RT	Rejuv	Angle RT left	Angle RT right	Comments
143	C174E/ 3-4nn	5		6	6	-24.07	11.69	6.57	1.8	10	6	-9.86	1	-6.69	1	11.93	1	14.67	1	5.33	1	7.55	0	1	2	3.54	1	999	999	999	1	3	3	999	89	87	
144	C174E/ 3-5a	6		1	2	30.09	12.9	8.27	3.4	6	5	8.88	1	8.67	3	19.13	1	23.9	1	11.93	0	0	0	1	3	1.77	1	1	1.93	2.22	3	324	4	1	68	76	
145	C174E/ 3-5b	6		1	4	24.28	11.08	8.52	2.7	6	5	8.67	1	10.17	3	16.93	1	18.19	1	7.13	0	0	0	1	3	2.38	1	1	2.15	3	324	3	1	69	75		
146	C174E/ 3-5c	6		1	6	19.73	10.24	5.55	1.2	6	5	11.87	1	4.87	1	8.5	0	14.7	1	9.19	0	0	0	1	3	5.63	1	1	2.56	2.18	3	324	3	1	73	33	
147	C174E/ 3-5d	6		1	2	25.27	11.24	6.69	1.9	3	5	15.13	1	9.53	1	10.33	0	17.06	1	5.87	0	0	0	1	3	2.86	999	1	2.59	2.47	1	3	3	2	88	70	
148	C174E/ 3-5e	6		1	6	20.12	10.2	5.62	1.3	10	5	8.34	1	6.66	2	12.63	1	13.12	1	10.2	0	0	0	1	4	5.28	1	1	2.21	2.78	3	324	3	1	78	75	
149	C174E/ 3-5f	6		1	2	18.73	10.04	5.43	1.2	6	5	8.5	1	9.82	2	11.62	1	7.7	1	8.52	0	0	0	1	2	2.74	1	1	0.98	2.25	3	324	3	1	73	85	
150	C174E/ 3-5g	5		1	6	19.71	9.58	6.36	1.2	10	5	9.74	4	3.75	2	10.54	1	16.14	1	6.96	0	0	0	1	3	4.45	1	2	999	2.49	3	324	3	1	77	66	
151	C174E/ 3-5h	6		1	2	19.8	9.97	4.2	1.1	6	5	4.6	1	7.17	2	13.93	1	11.95	1	6.9	1	0	0	1	4	999	5	1	1.93	3.13	3	324	3	1	72	75	
152	C174E/ 3-5i	6	7	1	1	17.81	8.25	5.51	0.8	6	5	3.43	1	3.71	2	11.32	1	13.48	1	8.04	0	0	0	1	4	2.42	1	1	1.38	2.46	3	324	3	1	73	71	
153	C174E/ 3-5j	6		1	2	15.63	10.52	4.22	0.8	6	5	4.58	1	6.41	2	13.16	1	8	1	9.8	0	0	0	1	4	3.33	1	1	1.14	2.67	3	324	3	1	75	70	
154	C174E/ 3-5k	5		6	2	-25.34	10.15	4.74	1.6	10	3	-23.35	1	-23.69	1	0	0	0	0	10.03	0	0	0	1	3	1.74	1	999	999	999	1	3	3	2	77	80	
155	C174E/ 3-5l	6		7	6	-19.73	9.07	5.36	1.1	6	5	6.4	1	5.47	3	-15.28	1	-9.35	1	-9.65	0	0	0	1	3	999	999	1	1.02	2.3	3	324	3	1	72	88	
156	C174E/ 3-5m	6	8	1	2	22.65	11.3	6.43	1.8	10	5	7.35	1	6.71	2	15.03	1	15.7	1	9.24	0	0	0	1	4	4.11	1	6	1.92	3.91	3	324	3	1	81	70	
157	C174E/ 3-5n	6	7	1	2	20.21	9.58	5.56	1.2	6	5	6.84	3	9.4	2	11.21	1	10.87	1	9.32	0	0	0	1	3	0.92	1	1	1.96	1.82	3	324	3	1	72	80	
158	C174E/ 3-5o	6		1	6	20.6	10.53	5.93	1.3	6	5	9.69	1	6.55	3	12.16	1	13.24	0	8.73	0	0	0	2	4	2.6	1	1	1.91	3.57	3	324	3	1	55	75	
159	C174E/ 3-5p	6	8	1	9	21.64	10.14	7.12	1.7	6	5	7.73	1	8.81	3	14.69	1	10.89	1	9.95	0	0	0	1	3	3.81	1	1	1.6	2	3	324	3	1	71	85	
160	C174E/ 3-5q	5	4	1	6	16.87	7.98	3.52	0.5	6	5	6.6	1	6.69	1	10.09	1	8.75	1	7.85	0	0	0	1	4	2.46	1	7	1.85	2.9	3	3	3	2	61	73	
161	C174E/ 3-5r	5		1	7	16.78	8.89	4.47	0.8	6	5	7.91	1	4.59	3	9.16	1	12.16	1	8.32	0	0	0	1	3	2.7	1	2	999	1.96	3	324	4	1	75	70	
162	C174E/ 3-5s	6		1	5	20.4	10.18	3.62	0.8	6	5	7.72	1	6.46	3	10.4	1	11.89	1	9.75	0	0	0	1	4	0.83	1	1	1.32	2.5	3	324	4	1	61	65	
163	C174E/ 3-5t	6		1	2	28.79	9.94	7.56	2.6	6	5	8.26	1	8.41	2	22.5	1	17.62	1	7.84	0	0	0	2	3	999	999	1	1.58	1.94	3	324	3	1	78	73	
164	C174E/ 3-5u	6		1	2	25.23	11.16	6.78	2.1	10	5	6.24	1	11.8	2	20.64	1	10.62	0	7.58	0	0	0	1	4	4.34	1	1	1.21	2.36	3	324	3	1	87	81	
165	C174E/ 3-5v	6		6	2	-23.82	9.79	5.94	1.6	6	5	6.18	1	6.34	3	18.11	1	15.82	1	8.1	0	0	0	1	3	3.78	1	999	999	1.88	3	324	4	1	59	84	tip broken
166	C174E/ 3-5w	5		6	6	-22.43	9.22	4.02	1	6	3	-21.02	1	-20.87	1	0	0	0	0	7.21	0	0	0	1	3	3.62	1	999	999	999	1	3	3	2	70	60	tip broken
167	C174E/ 3-5x	6	7	1	1	25.95	9.46	6.69	1.9	6	5	10.13	1	8.49	2	15.76	0	18.86	1	7.08	0	0	0	3	3	999	1	1	1.28	1.8	3	324	3	1	80	80	

ID	Cat #	Art. Function 1	Art. Function 2	Comp	Mat Color	L	W	TH	WT	X Sec	Plan Form/ Tool Type	Side A (L)	Side A (rt)	Side B (L)	Side B (rt)	Side C (L)	Side C (rt)	Side D (L)	Side D (rt)	Side E (L)	Side E (rt)	Side F (L)	Side F (rt)	% Cortex	Drsl Scar Prn	Pltfm TH	Bib thin	Bit Type	Bit L	Bit W	RT Class	RT Type	Invas RT	Rejuv	Angle RT left	Angle RT right	Comments	
168	C174E/ 3-5y	6		6	2	-25.3	9.76	6.95	1.6	4	3	-22.83	1	-25.73	4	0	0	0	0	0	0	0	0	1	2	999	999	1	1.38	2.54	3	324	3	1	83	73		
169	C174E/ 3-5z	6		1	4	18.55	10.1	6.65	1.3	6	5	9.06	1	6.1	3	11.53	1	10.13	1	9.75	0	0	0	3	4	2.24	1	1	0.96	1.17	3	324	4	1	84	72		
170	C174E/ 3-5aa	6		1	6	23.66	10.9	8.08	1.9	6	5	10.21	1	8.2	2	13.75	1	17.12	1	7.02	0	0	0	1	3	4.8	1	1	1.64	2.6	3	324	3	1	86	77		
171	C174E/ 3-5bb	6		1	4	20.65	9.12	5.57	1.2	6	5	5.98	1	6.5	2	16.58	1	13.56	1	8.3	1	0	0	1	3	3.78	1	3	1.19	2.17	3	324	3	1	71	68		
172	C174E/ 3-5cc	6		1	4	20.09	10.35	5.18	1.2	6	5	7.94	1	8.28	2	12.35	1	12.12	1	8.3	0	0	0	1	4	999	5	1	1.98	2.28	3	324	4	1	63	63		
173	C174E/ 3-5dd	6		1	2	24.91	10.5	6.2	2	6	5	10	1	4.65	2	17.1	1	19.54	1	7.85	0	0	0	1	2	4.73	1	1	1.81	2.39	3	324	3	1	64	72		
174	C174E/ 3-5ee	5		6	6	-21.17	10.58	6.2	1.4	6	5	-8	1	-5.1	1	11	1	15.22	1	7.38	0	0	0	1	4	4.15	1	999	999	2.09	3	3	3	2	78	85		
175	C174E/ 3-5ff	999		1	6	27.9	13.65	6.55	2.3	6	5	10.02	1	7.63	2	17.17	1	16.8	0	7.16	0	0	0	1	3	4.82	4	4	1.29	1.72	3	324	4	1	71	31	tip broken	
176	C174E/ 3-5gg	6		6	2	22.72	9.66	8.56	2.2	6	5	-6.95	2	-8.92	2	12.27	0	10.55	1	6.18	0	0	0	1	3	7.56	1	999	999	3.35	3	324	3	1	79	69	tip broken	
177	C174E/ 9-2a	2	8	1	6	53.2	29.81	9.03	13.9	10	3	53.3	3	51.02	0	999	999	999	999	18.45	0	0	0	2	4	7.71	1	3	999	999	3	324	2	2	75	55	preform. No flaking on left lateral edge	
178	C174E/ 9-2b	5		1	6	17.78	8.98	5.12	0.9	6	5	7.37	1	5.77	1	8.15	1	11.74	0	7.47	0	0	0	1	4	4.4	1	2	0.97	2.78	3	3	3	2	90	65	no flaking on left lateral edge	
179	C174E/ 9-2c	2		8	1	-19.48	-9.96	4.82	0.8	1	999	999	1	999	999	999	999	999	999	-5.87	0	0	0	3	2	999	999	999	999	999	1	3	3	999	0	65		
180	C174E/ 9-2d	5	999	1	1	19.8	8.37	6.5	1	3	4	4.96	0	16.95	0	19.98	1	7.47	0	0	0	0	1	4	999	999	0	999	999	1	3	2	999	63	55	no flaking on left lateral edge		
181	C174E/ 9-2e	6		7	4	-16.82	7.94	4.16	0.6	10	999	-13.21	4	16.99	4	0	0	0	0	999	999	0	0	1	3	999	6	1	1.61	2.46	3	324	3	2	60	77		
182	C174E/ 9-2f	6		1	6	15.72	8.37	3.71	0.7	6	5	3.61	1	4.13	2	11.41	1	12.95	1	8.23	0	0	0	1	4	999	999	1	1.08	2.14	3	324	3	1	55	65	snapped at prox	
183	C174E/ 9-2g	5		1	6	22.62	8.56	5.32	1.3	6	5	5.37	4	2.33	3	16.92	1	17.01	1	7.79	0	0	0	1	4	999	999	1	1.15	2.14	3	324	3	1	67	77	snapped at prox	
184	C174E/ 9-2h	6		7	6	-13.93	7.82	4.61	0.6	10	5	6.11	3	4.88	3	-3.29	1	-6.25	1	1.16	0	0	0	1	3	999	999	1	1.38	3.02	3	324	3	1	73	81	maybe whole	
185	C174E/ 9-2i	6		1	4	19.26	8.92	8.41	1.4	4	5	6.8	3	5.4	3	11.75	1	14.69	1	7.43	0	0	0	1	3	999	999	1	1.67	2.4	3	324	3	1	65	70	prox snapped	
186	C174E/ 9-2j	5		1	6	24.21	9.66	5.1	1.2	6	5	11.85	1	5.77	1	13.71	1	14.79	1	9.32	0	0	0	1	3	999	999	1	1.26	2.34	3	3	3	2	84	83	prox snapped	
187	C174E/ 9-2k	6		6	1	-21.42	11.53	7.42	1.6	3	6	-6.6	1	-8.51	3	13.44	1	7.26	1	7.22	0	7.23	0	2	4	999	999	999	999	3.22	3	324	3	1	66	73	tip broken. side E and F= cortex	
188	C174E/ 9-2l	6		1	2	19.19	11.5	6.33	1.6	6	5	7.89	1	6.08	2	9.94	1	10.63	1	11.3	0	0	0	1	4	6.1	1	1	1.46	2.46	3	324	3	1	65	70		
189	C174E/ 9-2m	6	5	1	2	27.46	11.58	6.78	2.6	6	5	7.01	1	9.22	2	20.2	1	20.49	1	5.07	1	0	0	2	4	999	5	1	1.39	2.76	3	324	4	1	90	83		
190	C174E/ 9-2n	5	999	6	6	20.11	10.57	6.08	1.6	6	5	-6.52	1	999	999	14.68	1	16.23	1	8.67	0	0	0	1	3	5.41	1	999	999	999	3	3	3	999	75	77	tip broken.	
191	C174E/ 9-2o	6		1	6	28	11.55	6.06	2.3	6	5	7.6	1	9.2	3	19.44	1	16.32	1	11.13	1	0	0	1	3	1.95	2	1	1.94	2.67	3	324	4	1	83	77		

ID	Cat #	Art. Function 1	Art. Function 2	Comp	Mat Color	L	W	TH	WT	X Sec	Plan Form/ Tool Type	Side A (L)	Side A (rt)	Side B (L)	Side B (rt)	Side C (L)	Side C (rt)	Side D (L)	Side D (rt)	Side E (L)	Side E (rt)	Side F (L)	Side F (rt)	% Cortex	DrsI Scar Ptn	Pltfm TH	Bib thin	Bit Type	Bit L	Bit W	RT Class	RT Type	Invas RT	Rejuv	Angle RT left	Angle RT right	Comments		
192	C174E/ 9-2p	6	5	1	4	22.42	11.6	7.9	2.3	4	5	8.74	1	5.77	3	13.76	1	19.3	1	10.44	0	0	0	1	2	999	999	1	0.97	2.02	3	324	4	1	75	85			
193	C174E/ 9-2q	6		7	4	-25.39	10.94	7.63	2	6	5	5.71	1	7.02	3	-10.37	1	-12.81	1	999	999	0	0	1	3	999	999	1	1.25	2.41	3	324	3	1	73	77	prox snapped		
194	C174E/ 9-2r	5		6	1	-21.86	15.07	6.89	2.4	6	5	-6.22	2	-9.3	1	9.55	1	11.63	0	10.88	0	0	0	1	2	2.66	1	999	999	999	3	324	3	2	78	110	tip broken		
195	C174E/ 9-2s	8	5	1	6	27.29	12.01	8.1	2.8	6	5	7.56	1	6.16	2	21.42	1	22.33	1	7.53	0	0	0	1	3	3.6	1	6	1.09	1.62	3	324	3	1	77	75			
196	C174E/ 9-2t	6		1	4	24.23	9.46	7.8	1.9	4	5	4.85	1	7.32	3	19.57	1	13.5	1	9	1	0	0	1	3	4.68	3	1	1.31	2.26	3	324	3	1	53	60			
197	C174E/ 9-3a	5	6	1	4	23.58	10.19	8	1.8	4	6	7.21	1	7.41	3	12.67	1	11.27	1	6.14	3	7.06	1	1	3	999	999	1	1.45	1.77	3	324	4	1	75	55	bipointed.		
198	C174E/ 9-3b	5	8	1	4	23.05	9.55	6.51	1.4	4	5	7.44	1	4.98	2	17.75	10	17.14	0	3.86	0	0	0	4	1	1.15	1	6	0.7	0.94	3	324	3	1	65	78	unmodified. left lateral edge= cortex		
199	C174E/ 9-3c	999		6	1	-22.73	12.38	8.53	2.1	4	1	-23.34	0	-23.07	1	0	0	0	0	2.18	0	0	0	2	3	2.18	1	999	999	999	1	3	2	999	84	58	side d= cortex		
200	C174E/ 9-3d	999		6	4	-12.08	7.85	4.47	0.4	4	999	-11.96	1	-6.71	1	0	0	0	0	7.85	0	0	0	1	3	7.85	1	999	999	999	1	3	2	999	65	70			
201	C174E/ 9-3e	6		1	2	17.25	10.39	4.91	0.8	6	5	7.17	1	5.31	2	12.13	1	11.97	1	6.08	0	0	0	1	4	999	999	1	1.38	2.54	3	324	3	1	64	65			
202	C174E/ 9-3f	6		1	6	16.72	8.3	5.07	0.6	4	5	5.83	1	6.23	3	11.3	1	9.42	1	6.56	0	0	0	1	3	999	999	1	1.01	2.16	3	324	3	1	80	72			
203	C174E/ 9-3g	6		1	4	19.37	10.87	5.39	0.9	3	5	9.43	1	8.12	2	10.8	1	12.34	1	3.36	0	0	0	2	3	1.74	1	1	1.05	2.14	3	324	3	1	73	67			
204	C174E/ 9-3h	6		1	4	16.2	9.76	4.21	0.6	6	5	5.29	1	8.7	2	11.29	1	7.92	1	4.55	1	0	0	1	2	999	5	1	2.62	2.62	3	324	4	1	65	85			
205	C174E/ 9-3i	6	7	1	2	15.18	8.92	4.04	0.7	6	5	6.06	1	6.86	2	8.47	1	9.07	1	7.79	0	0	0	1	3	3.97	1	1	1.25	2.23	3	324	3	1	85	75	chisel?		
206	C174E/ 9-3j	0		0	6	0	0	0	2.1	999	999	0	999	0	999	0	999	0	999	0	999	0	999	999	999	999	0	999	999	0	0	999	999	999	999	999	999	999	angular waste
207	C174E/ 9-3k	999		6	6	-16.77	9.77	4.4	0.8	6	5	999	999	999	999	-14.2	1	-16.16	1	5.63	0	0	0	1	2	4.08	1	999	999	999	3	3	3	999	63	73	tip not present		
208	C174E/ 9-5a	5		6	4	20.68	11.84	4.46	1.2	10	3	-21.29	1	-20.16	1	0	0	0	0	10.77	0	0	0	1	4	999	999	999	999	2.71	3	3	3	2	70	75			
209	C174E/ 9-7a	5		1	1	19.38	9.96	7.5	1.6	6	5	9.4	1	6.32	1	11.72	1	15	1	8.29	0	0	0	3	1	4.65	1	4	1.1	1.38	3	3	3	2	74	82			
210	C174E/ 9-7b	5		1	2	21.28	9.55	5.67	1.3	10	5	8.31	1	7.92	3	14.44	1	14.7	0	6.12	0	0	0	1	3	4.02	1	3	1.23	2.23	3	324	3	1	108	78	left lateral edge no flaking		
211	C174E/ 9-7c	6		1	2	21.74	8.14	4.84	1.2	6	5	6.13	1	7.25	2	16.57	1	12.3	1	7.07	0	0	0	2	3	999	999	1	1.7	2.65	3	324	3	1	82	75			
212	C174E/ 9-7d	6		1	2	21.49	13.44	8.44	2.4	3	5	3.98	1	9.72	2	14.65	1	14.1	1	11.82	0	0	0	3	3	6.66	1	1	1.63	1.88	3	324	3	1	90	72			
213	C174E/ 9-7e	6		1	6	22.41	11.08	7.49	1.8	10	5	8.66	3	7.31	2	13.35	1	15.6	1	10.62	1	0	0	1	3	2.21	5	1	1.49	2.49	3	324	4	1	78	79			
214	C174E/ 9-7f	5	8	1	4	24.38	12.08	6.36	2.3	3	5	10.97	1	7.1	2	15.07	1	17.26	1	9.48	0	0	0	1	3	5.2	1	6	1.77	1.13	3	324	4	1	68	66	blank? unmod tip		
215	C174E/ 9-7g	6		1	4	21.39	10.99	5.16	1.4	6	5	8.15	1	10.47	2	14.29	3	12.82	1	7.72	0	0	0	1	3	4.96	1	1	2.06	2.36	3	324	3	1	63	80			

ID	Cat #	Art. Function 1	Art. Function 2	Comp	Mat Color	L	W	TH	WT	X Sec	Plan Form/ Tool Type	Side A (L)	Side A (rt)	Side B (L)	Side B (rt)	Side C (L)	Side C (rt)	Side D (L)	Side D (rt)	Side E (L)	Side E (rt)	Side F (L)	Side F (rt)	% Cortex	Drsl Scar Ptn	Pltfm TH	Bib thin	Bit Type	Bit L	Bit W	RT Class	RT Type	Invas RT	Rejuv	Angle RT left	Angle RT right	Comments
216	C174E/ 9-7h	5	8	1	6	24.25	12.47	9.75	2.5	3	5	5.35	1	4.3	3	13.28	1	21.71	1	10.19	0	0	0	1	2	9.84	1	6	0.98	1.55	3	324	4	1	83	76	blank?
217	C174E/ 9-7i	6		1	7	17.18	8.85	6.07	1.2	6	5	3.33	1	5.7	3	13.55	1	12.2	1	8.43	0	0	0	1	4	4.84	1	1	1.4	2.1	3	324	3	1	80	77	
218	C174E/ 9-7j	6	5	1	1	18.7	8.81	6.07	1.2	6	5	6.32	3	3.74	3	13.14	1	15.83	1	8.63	0	0	0	2	1	4.48	1	1	1.25	1.63	3	324	4	1	81	65	
219	C174E/ 9-7k	6		1	4	26.61	11.99	9.04	2.9	6	5	10.47	1	7.71	3	18.37	1	20.09	1	6.44	0	0	0	1	3	999	1	1	1.73	2.13	3	324	4	1	64	68	
220	C174E/ 9-7l	5		1	6	22.1	11.39	5.67	1.9	6	5	8.28	1	7.75	1	14.68	1	15.91	1	8.95	0	0	0	1	3	3.88	5	1	1.44	2.18	3	3	3	2	61	72	
221	C174E/ 5-2a	5		4	4	25.97	11.6	5.43	1.7	10	5	-10.25	1	-13.57	1	14.3	0	10.05	0	9.56	999	0	0	1	3	999	999	999	999	999	1	3	3	2	81	70	
222	C174E/ 5-2b	8		1	4	24.95	10.65	8.12	1.2	6	2	999	0	999	0	999	0	999	0	999	0	0	0	1	4	999	999	999	999	999	999	999	999	2	999	999	blank?
223	C174E/ 7-5a	5		6	1	32.06	16.12	5.55	2.4	10	3	-30.78	1	-32.58	1	0	0	0	0	13.04	0	0	0	2	1	2.62	1	999	999	1.56	1	3	3	2	72	83	
224	C174E/ 8-4a	6	5	1	4	15.91	9.82	3.68	0.6	6	4	4.25	2	3.44	1	11.14	1	13.22	1	5.45	0	0	0	1	3	2.4	1	1	1.09	1.94	3	324	3	1	74	60	
225	C174E/ 8-5a	6	5	1	1	16.85	10.17	7.76	1.3	4	5	8.78	1	4.69	3	9.38	1	10.36	0	9.23	1	0	0	1	3	999	5	1	1.31	1.87	3	324	3	1	75	85	left lateral edge no flaking
226	C174E/ 9-6a	6		1	6	17.25	9.1	4.12	0.7	6	5	5.7	1	4.46	1	13.47	1	11.78	1	6.5	0	0	0	1	3	2.47	1	1	1.13	1.71	3	3	3	2	64	61	
227	C174C/ 2-2a	5		4	4	15.75	11.93	6.43	1.8	4	5	-7.76	1	5.74	1	8.41	1	5.5	1	999	999	0	0	1	2	999	6	999	999	2.5	1	3	3	2	57	40	broken tip
228	C174C/ 6-3a	6		1	6	17.46	8.07	3.41	0.6	6	5	5.09	1	5.18	2	13.44	1	13.84	1	7.09	0	0	0	1	3	1.86	1	1	1.21	1.58	3	324	4	1	53	83	
229	C174C/ 6-3b	5		1	6	18.65	8.04	5.21	0.7	6	6	6.52	1	6.19	1	9.02	1	9.78	1	7.55	0	4.65	0	1	3	999	0	1	1.33	1.51	3	3	3	2	75	78	
230	C174C/ 6-4a	6	7	1	10	12.55	14.44	4.55	0.9	6	3	12.88	4	14.19	4	0	0	0	0	0	0	0	0	2	4	999	0	5	1.04	1.96	3	324	4	2	84	80	may have a refit. Chisel. Bec.
231	C174C/ 6-4b	999		6	6	-15.5	9.15	4.75	0.8	6	5	999	999	999	999	14.03	1	9.2	1	7.44	0	0	0	1	3	3.88	1	999	999	999	3	3	3	999	75	72	
232	C174C/ 6-4c	6		4	7	-18.06	9.04	6.17	1.2	6	5	-6.18	1	-4.41	2	13.18	1	12.7	1	7.62	0	0	0	1	3	999	0	1	999	1.33	3	324	4	1	79	67	
233	C174C/ 6-4d	6		1	2	28.56	12.45	8.5	2.8	6	5	12.85	1	14.89	3	16	1	14.97	1	8.03	0	0	0	3	3	999	0	1	2.22	2.5	3	324	4	1	82	63	
234	C174C/ 6-4e	6		1	6	23.28	10.18	5.56	1.3	6	5	7.1	1	12.97	2	17.47	1	10.04	1	7.14	0	0	0	1	3	1.72	1	1	1.08	1.54	3	324	3	1	70	63	
235	C174C/ 6-4f	6		1	6	16.44	8.95	4.89	0.9	6	5	6.52	1	4.19	2	9.95	1	12.14	1	7.12	0	0	0	1	4	999	0	1	1.45	1.71	3	324	4	1	81	81	
236	C174C/ 6-4g	6		1	4	20.97	11.34	7.33	1.7	6	5	6.6	1	6.69	3	10.48	1	13.83	1	10.94	0	0	0	1	3	3.07	1	2	1.1	2.09	3	324	4	1	85	80	
237	C174C/ 6-4h	6		1	10	21.07	12.45	8.25	1.9	6	5	7.67	1	4.88	3	14.09	1	15.74	1	8.66	0	0	0	1	4	6.5	1	1	1.32	1.68	3	324	3	1	75	60	
238	C174C/ 6-4i	6		1	1	26.82	11.74	9.31	3	6	5	7.63	1	11.1	3	13.07	1	13.8	1	10.62	2	0	0	2	2	999	6	1	1.38	2.41	3	324	4	1	84	77	
239	C174C/ 6-4j	5		6	6	24.72	10.95	6.05	2.2	6	5	-10.47	1	-9.23	1	13.21	1	15.83	1	7.58	0	0	0	1	3	4.92	1	999	999	1.95	3	3	3	2	63	87	

ID	Cat #	Art. Function 1	Art. Function 2	Comp	Mat Color	L	W	TH	WT	X Sec	Plan Form/ Tool Type	Side A (L)	Side A (rt)	Side B (L)	Side B (rt)	Side C (L)	Side C (rt)	Side D (L)	Side D (rt)	Side E (L)	Side E (rt)	Side F (L)	Side F (rt)	% Cortex	Drsl Scar Prn	Pltfm TH	Bib thin	Bit Type	Bit L	Bit W	RT Class	RT Type	Invas RT	Rejuv	Angle RT left	Angle RT right	Comments			
240	C174C/ 6-4k	0		999	999	0	0	0	0	999	999	0	0	0	0	0	0	0	0	0	0	0	0	999	999	999	999	999	999	999	999	999	999	999	999	999	999			
241	C174C/ 6-4l	6		1	6	26.67	13.74	9.14	3.8	3	5	12.84	1	9	3	16.26	1	18.45	1	11.05	0	0	0	1	4	6.63	1	1	1.24	2.05	1	324	4	1	83	69				
242	C174C/ 6-4m	8	999	1	4	20.05	9.35	7.14	1.4	6	5	4.44	1	8.31	3	6.29	1	11.35	2	9.68	0	0	0	2	2	999	1	6	999	999	3	324	3	999	70	70				
243	C174C/ 7-5a	0		999	999	0	0	0	0	999	999	0	0	0	0	0	0	0	0	0	0	0	0	999	999	999	999	999	999	999	999	999	999	999	999	999	999	999	angular waste. Preform but discarded? Some flaking-probably bulbar thinning	
244	C174C/ 7-5b	0		999	999	0	0	0	0	999	999	0	0	0	0	0	0	0	0	0	0	0	0	999	999	999	999	999	999	999	999	999	999	999	999	999	999	999	flake	
245	C174C/ 7-5c	0		999	999	0	0	0	0	999	999	0	0	0	0	0	0	0	0	0	0	0	0	999	999	999	999	999	999	999	999	999	999	999	999	999	999	999	angular waste	
246	C174C/ 8-1a	0		999	999	0	0	0	0	999	999	0	0	0	0	0	0	0	0	0	0	0	0	999	999	999	999	999	999	999	999	999	999	999	999	999	999	999	angular waste	
247	C174C/ 8-2a	5		1	1	35.64	20.84	10.74	6.2	6	3	33.47	4	35.48	1	0	0	0	0	0	0	0	0	0	3	999	0	2	1.14	1.75	3	324	3	2	84	55				
248	C174C/ 8-2b	5		1	7	25.56	14.08	5.41	1.8	6	4	17.04	6	15.18	1	14.26	1	12.21	1	0	0	0	0	1	2	999	5	1	1.37	2.08	3	324	4	2	65	57	bipointed.			
249	C174C/ 8-2c	5		1	110	13	10.82	1.61	0.2	6	3	13.42	1	13.6	2	0	0	0	0	0	0	0	0	1	3	0.69	1	1	1.36	1.61	3	3	3	2	999	999	angles to small to measure			
250	C174C/ 10-10a	5		6	4	-19.95	6	5	0.6	6	3	-17.63	1	19.62	1	0	0	0	0	0	0	0	0	1	3	1.71	1	999	999	1.94	3	3	2	2	50	50	tip broken			
251	C174C/ 10-10b	5		1	10	18.72	9.88	4.11	0.7	6	3	18.51	1	18.66	1	0	0	0	0	0	0	0	0	4	2.63	1	2	0.92	1.32	3	3	3	2	71	74					
252	C174C/ 10-10c	5		1	2	33.34	10.91	5.55	1.8	4	5	8.46	1	24.9	1	23.8	1	9.96	0	5.93	0	0	0	1	3	2.67	1	1	1.11	1.62	3	3	3	2	76	76				
253	C174C/ 10-10d	5	999	6	4	32.32	11.46	7.89	2.9	3	5	-11.36	1	-9.63	1	17.65	1	18.62	1	5.7	0	0	0	1	2	2.2	1	999	999	999	3	3	4	2	76	83				
254	C174C/ 10-10e	0		999	999	0	0	0	0	999	999	0	0	0	0	0	0	0	0	0	0	0	0	999	999	999	999	999	999	999	999	999	999	999	999	999	999	999	angular waste	
255	C174C/ 10-10f	0		999	999	0	0	0	0	999	999	0	0	0	0	0	0	0	0	0	0	0	0	999	999	999	999	999	999	999	999	999	999	999	999	999	999	999	999	flake
256	C174C/ 10-11a	6		1	10	18.49	10.47	4.92	0.7	4	3	17	1	17.5	4	0	0	0	0	0	0	0	0	1	4	5.28	1	1	1.63	2.33	3	324	3	1	74	75				
257	C174C/ 10-11b	5		1	4	15.01	7.4	3.88	0.4	3	4	15.09	1	6.11	3	0	0	8.28	1	6.12	0	0	0	1	4	2.84	1	1	1.33	1.59	3	324	4	1	75	81				
258	C174C/ 10-11c	5		7	4	-15.95	-13.04	-6.98	1.1	6	3	-16.87	1	-16.53	1	0	0	0	0	0	0	0	0	1	3	999	0	1	1.64	2.95	3	3	3	2	50	84				
259	C174C/ 10-11d	6		1	4	18.01	11.68	4.36	0.9	6	5	7.74	1	9.22	1	7.05	1	9.76	1	11	0	0	0	1	4	3.5	1	1	1.42	3.02	3	3	4	2	79	86				
260	C174C/ 11-2a	999		2	4	0	0	0	1	999	999	0	0	0	0	0	0	0	0	0	0	0	0	999	999	999	999	999	999	999	999	999	999	999	999	999	999	999	edge ground	
261	C174C/ 11-2b	0		999	999	0	0	0	0	999	999	0	0	0	0	0	0	0	0	0	0	0	0	999	999	999	999	999	999	999	999	999	999	999	999	999	999	999	999	flake
262	C174C/ 11-2c	2		1	10	26.97	12.29	6.34	1.8	6	4	26.97	1	26.97	1	0	0	0	0	0	0	0	0	1	3	999	1	999	999	999	1	3	3	2	85	73				

ID	Cat #	Art. Function 1	Art. Function 2	Comp	Mat Color	L	W	TH	WT	X Sec	Plan Form/ Tool Type	Side A (L)	Side A (rt)	Side B (L)	Side B (rt)	Side C (L)	Side C (rt)	Side D (L)	Side D (rt)	Side E (L)	Side E (rt)	Side F (L)	Side F (rt)	% Cortex	Drsl Scar Ptn	Pltfm TH	Bib thin	Bit Type	Bit L	Bit W	RT Class	RT Type	Invas RT	Rejuv	Angle RT left	Angle RT right	Comments	
263	C174C/ 11-2d	0		999	999	0	0	0	3.2	999	999	0	0	0	0	0	0	0	0	0	0	0	0	999	999	0	999	999	0	0	999	999	999	999	999	999	999	flake tool. Not same typology- lateral edge worked marginally on dorsal. Secondary flake some cortex present
264	C174C/ 11-2e	0		999	999	0	0	0	0	999	999	0	0	0	0	0	0	0	0	0	0	0	0	999	999	0	999	999	0	0	999	999	999	999	999	999	999	flake
265	C174C/ 11-2f	0		999	999	0	0	0	8.1	999	999	0	0	0	0	0	0	0	0	0	0	0	0	999	999	0	999	999	0	0	999	999	999	999	999	999	999	flake. Some retouch but probably post depositional
266	C174C/12-14a	5		1	4	19.19	8.5	5.24	0.9	6	4	10.8	1	19.08	1	11.93	1	0	0	5.3	0	0	0	1	2	4.2	1	1	1.51	2.33	3	3	3	2	80	85	great example of a bit type	
267	C174C/ 12-15a	5		1	4	15.84	7.78	4.13	0.5	3	3	15.3	1	15.85	1	0	0	0	0	7.37	0	0	0	1	3	3.11	1	1	1.19	1.53	3	3	4	2	85	84		
268	C174C/ 12-15b	5		1	4	18.46	10.95	6.31	1.2	6	3	17.02	1	19.93	1	0	0	0	0	9.84	0	0	0	1	4	6.27	1	1	1.66	1.97	3	3	4	2	83	85		
269	C174C/ 12-15c	0		999	6	0	0	0	4.9	999	999	0	0	0	0	0	0	0	0	0	0	0	0	999	999	999	999	999	0	0	999	999	999	999	999	999	999	flake tool. One edge worked bifacially.
270	C174C/ 12-15d	5		6	4	23.7	7.47	6.26	0.9	3	3	-23.51	1	-22.19	1	0	0	0	0	5.7	1	0	0	1	3	999	5	5	999	999	3	3	4	2	73	75		
271	C174C/ 12-15e	0		999	999	0	0	0	5.5	999	999	0	0	0	0	0	0	0	0	0	0	0	0	999	999	999	999	999	0	0	999	999	999	999	999	999	999	flake tool. Worked on one edge. Cortex removing flake. Retouch is partial bifacial.
272	C174C/ 12-15f	0		1	7	34.11	26.5	11.62	7.3	4	4	13.11	1	33.32	4	22.36	0	9.71	0	18.28	0	0	0	3	5	3.24	1	1	1.1	1.52	3	324	4	2	999	999	left edge angle too small. Right lateral side is cortex. Flake tool with unique bit. Cortex removing flake with bulb present	
273	C174C/ 14-9a	5		1	4	26.2	11.1	6	1.5	6	3	26.27	1	22.64	1	0	0	0	0	10.9	1	0	0	1	4	999	5	1	1.5	1.64	1	3	3	2	66	65	good example. Platform removed	
274	C174C/ 14-9b	0		1	999	0	0	0	5.5	999	999	0	0	0	0	0	0	0	0	0	0	0	0	999	999	0	999	999	0	0	999	999	999	999	999	999		
275	C174C/ 14-9c	6		1	4	20.21	9.26	5.64	1.2	3	5	13.8	1	14	3	7.29	1	8.09	1	8.06	0	0	0	1	4	4.53	1	1	1.78	1.75	3	324	4	1	65	81	pecked? Rejuv flake minor	
276	C174C/ 14-19a	5		1	10	24.48	23.11	6.21	2.9	6	2	999	1	999	1	999	1	999	1	999	1	0	0	2	5	3.93	1	1	1.33	1.92	1	3	4	2	90	72		
277	C174C/ 14-19b	5		1	7	22.52	10.75	6.37	0.9	1	3	23.49	1	21.49	1	0	0	0	0	10.63	0	0	0	1	5	999	0	6	1.66	1.35	1	3	3	2	35	87	left and right lateral no flaking. Tip unmodified?	

ID	Cat #	Art. Function 1	Art. Function 2	Comp	Mat Color	L	W	TH	WT	X Sec	Plan Form/ Tool Type	Side A (L)	Side A (rt)	Side B (L)	Side B (rt)	Side C (L)	Side C (rt)	Side D (L)	Side D (rt)	Side E (L)	Side E (rt)	Side F (L)	Side F (rt)	% Cortex	DrsI Scar Prn	Pltfm TH	Bib thin	Bit Type	Bit L	Bit W	RT Class	RT Type	Invas RT	Rejuv	Angle RT left	Angle RT right	Comments		
278	C174C/ 14-19c	5		1	11	28.05	13.44	8.61	2.1	4	5	13.82	1	7.92	1	18.5	0	19.27	0	7.88	0	0	0	1	3	3.7	1	2	1.69	1.71	1	3	3	2	50	45	left and right lateral no flaking		
279	C174C/ 14-19d	5		1	1	22.84	14.13	6.53	2.1	6	5	11.4	1	12.07	1	14.26	0	10.19	0	10.49	0	0	0	2	3	5.65	1	1	1.4	2.05	1	3	3	2	76	60	pecked. Left and right lateral cortex		
280	C174C/ 14-19e	0		999	999	0	0	0	0	999	999	0	0	0	0	0	0	0	0	0	0	0	0	999	999	0	999	999	0	0	999	999	999	999	999	999	999	999	flake
281	C174C/ 15-7a	6		1	10	30.73	15.37	8.05	2.8	6	5	14.05	3	13	1	18.1	1	21.16	1	9.25	0	0	0	1	2	7.72	1	1	1.43	2.22	3	324	3	2	38	50	pecked bit? Right lateral side no flaking		
282	C174C/ 15-7b	0		999	999	0	0	0	23.5	999	999	0	0	0	0	0	0	0	0	0	0	0	0	999	999	0	999	999	0	0	999	999	999	999	999	999	999	999	flake tool with retouch use wear at proximal end of flake and on both sides of platform
283	C174C/ 16-6a	0		999	999	0	0	0	11.5	999	999	0	0	0	0	0	0	0	0	0	0	0	0	999	999	0	999	999	0	0	999	999	999	999	999	999	999	999	flake tool with retouch on one lateral edge. Retouch use wear bifacially. Other side is cortex
284	C174C/ 20-4a	5		1	6	39.84	14	6.09	3.2	4	3	39.28	1	37.64	4	0	0	0	0	10	0	0	0	2	4	3.9	1	2	1.28	1.9	3	324	4	2	45	55	right side heavy retouch.		
285	C174C/ 20-4b	6		1	10	38.88	30.27	8	7	4	3	39.48	4	34.83	4	0	0	0	0	27.36	0	0	0	1	3	2.14	1	3	3.25	4.19	3	324	4	2	75	83			
286	C174C/ 20-6a	6		1	10	24.35	11.53	4.37	0.9	4	5	19.24	1	19.68	4	4.47	0	3.75	0	11	0	0	0	1	3	2.18	1	1	6.28	3.5	3	324	4	2	110	85	Very long bit. Platform is cortex		
287	C174C/ 20-6b	5		1	7	23.8	16.4	7.42	2.6	6	3	21.47	1	24.11	4	0	0	0	0	15.64	0	0	0	2	5	0	0	2	0.78	1.89	3	324	3	2	100	68			
288	C174C/ 21-2a	2		1	999	0	0	0	77.7	999	999	0	0	0	0	0	0	0	0	0	0	0	0	999	999	0	999	999	0	0	999	999	999	999	999	999	999	999	scarppe/ chopper? Platform intact, triangular shape, lateral edge worked dorsal
289	C174C/ 22-5a	0		1	999	0	0	0	2.5	999	999	0	0	0	0	0	0	0	0	0	0	0	0	999	999	0	999	999	0	0	999	999	999	999	999	999	999	999	flake tool. Preform? Lateral edges with retouch and use wear, but no defined bit
290	C174C/ 22-5b	0		1	999	0	0	0	2	999	999	0	0	0	0	0	0	0	0	0	0	0	0	999	999	0	999	999	0	0	999	999	999	999	999	999	999	999	flake. Preform? Not modified
291	C174C/ 22-6a	6		1	6	15.98	6.93	4.8	0.5	4	5	5.14	1	5.65	3	11.62	1	10.74	1	2.96	0	0	0	1	3	2.26	1	1	0.77	1.45	3	324	3	1	54	63	good example of bit		
292	C174C/ 22-6b	6		1	1	23.66	12.84	7.57	2.7	10	5	5.23	1	3.75	3	17.67	1	20.28	1	10.8	0	0	0	1	4	999	0	1	0.89	2.54	3	324	3	1	84	85	rejuv flake minor. Bulb		

ID	Cat #	Art. Function 1	Art. Function 2	Comp	Mat Color	L	W	TH	WT	X Sec	Plan Form/ Tool Type	Side A (L)	Side A (rt)	Side B (L)	Side B (rt)	Side C (L)	Side C (rt)	Side D (L)	Side D (rt)	Side E (L)	Side E (rt)	Side F (L)	Side F (rt)	% Cortex	Drsl Scar Ptn	Pltfm TH	Bib thin	Bit Type	Bit L	Bit W	RT Class	RT Type	Invas RT	Rejuv	Angle RT left	Angle RT right	Comments	
																																					snapped off?	
293	C174C/ 22-6c	999		999	999	0	0	0	0.3	999	999	0	0	0	0	0	0	0	0	0	0	0	0	999	999	999	0	999	0	0	999	999	999	999	999	999	999	
294	C174C/ 22-6d	5		6	4	33.25	21.09	9.28	5.4	2	3	-29.2	1	-32.98	1	0	0	0	0	18.79	0	0	0	1	2	999	0	999	999	999	1	3	3	2	70	50		
295	C174C/ 22-6e	2		1	7	39.44	25.29	11.12	11.4	4	2	0	0	0	0	0	0	0	0	0	0	0	0	4	1	999	5	999	999	999	1	3	3	2	0	0		
296	C174C/ 22-7a	6	4	1	4	31.97	10.26	4.13	0.9	6	3	31.24	1	32	1	0	0	0	0	6.76	0	0	0	1	4	0.9	1	1	15.58	5.95	3	3	4	2	80	76		
297	C174C/ 23-3a	0		999	10	0	0	0	17	999	999	0	0	0	0	0	0	0	0	0	0	0	0	999	999	0	999	999	0	0	999	999	999	999	999	999	999	flake tool. Distal end of flake was worked bifacially
298	C174C/ 23-3b	0		999	999	0	0	0	0	999	999	0	0	0	0	0	0	0	0	0	0	0	0	999	999	0	999	999	0	0	999	999	999	999	999	999	999	flake with no retouch. Platform is cortex
299	C174E/ 3- 1qqq	6	7	1	9	16.96	7.7	3.5	0.6	6	5	5.86	1	5.08	2	11.17	0	13.28	1	5.78	0	0	0	1	3	2.74	1	1	1.13	1.83	3	324	3	1	55	78	no flaking retouch on right lateral	
300	C174E/ 3-1rrr	6	7	1	2	21.25	10.7	6.53	1.4	4	6	8.39	1	5.78	3	7.45	1	14.64	0	11.37	0	3.48	0	5	1	1.68	1	1	1.61	2.38	3	324	3	1	82	62	no flaking retouch on left side and partial on right side	

REFERENCES

- Aldenderfer, Mark S.
1991 The Structure of Late Classic Lithic Assemblages in the Central Petén Lake Region, Guatemala. In *Maya Stone Tools: Selected Papers from the Second Maya Lithic Conference*, edited by T. R. Hester and H. J. Shafer, pp. 119-142. Prehistory Press, Madison.
- Aldenderfer, Mark S., Larry R. Kimball, and April Sievert
1989 Microwear Analysis in the Maya Lowlands: The Use of Functional Data in a Complex-Society Setting. *Journal of Field Archaeology* 16(1):47-60
- Andrefsky, William Jr.
2006 *Lithics: Macroscopic Approaches to Analysis*. University Press, Cambridge.
- Arnold, Philip J.
1991 Dimensional Standardization and Production Scale in Mesoamerican Ceramics. *Latin American Antiquity* 2(4): 363-370.
- Arnold, Jeanne E. and Ann Munns
1994 Independent and Attached Specialization: The Organization of Shell Bead Production in California. *Journal of Field Archaeology* 21(4): 473-489.
- Aoyama, Kazuo
2007 Elite Artists and Craft Producers in Classic Maya Society: Lithic Evidence from Aguateca, Guatemala. *Latin American Antiquity* 18(1):3-26.
- Barrientos, Tomas Q. and Arthur Demarest
2006 Cancuen: Puerto del Mundo Maya Clasico. Paper presented at the XX Simposio de Investigaciones Arqueologicas en Guatemala, Julio de 2006.
- Becker, Marshall J.
1973 Archaeological Evidence for Occupational Specialization among the Classic Period Maya at Tikal, Guatemala. *American Antiquity* 38(4):396-406.
- Bernard, Russell H.
2002 *Research Methods in Anthropology: Qualitative and Quantitative Approached*. AltaMira Press, Walnut Creek.
- Blackman, James M., Gil J. Stein, and Pamela B. Vandiver
1993 The Standardization Hypothesis and Ceramic Mass Production: Technological, Compositional, and Metric Indexes of Craft Specialization at Tell Leilan, Syria. *American Antiquity* 58(1): 60-80.

Braswell, Geoffrey E.

- 2004 Lithic Analysis in the Maya Area. In *Continuities and Changes in Maya Archaeology: Perspectives at the Millennium*, edited by C. W. Golden and G. Borgstede, pp. 177-200. Routledge, New York.

Chase, Arlen F.

- 2004 Politics, Politics, and Social Dynamics: "Contextualizing the Archaeology of the Belize Valley and Caracol. In *The Archaeology of the Belize Valley: Half a Century Later*, pp. 320-334, edited by J. Garber. University Press of Florida, Gainesville.

Chase, Arlen F. and Diane Z. Chase

- 1994 Details in the Archaeology of Caracol, Belize: An Introduction. In *Studies in the Archaeology of Caracol, Belize*, pp. 1-11, edited by D. Chase and A. Chase. Pre-Columbian Art Research Institute Monograph 7, San Francisco.
- 2000 Epicentral Ring Settlement: Report of the Spring 2000 Field Season at Caracol, Belize. Belize Institute of Archaeology.
- 2001 Ancient Maya Causeways and Site Organization at Caracol, Belize. *Ancient Mesoamerica* 12(2):273-281.
- 2003 Minor Centers, Complexity and Scale in Lowland Maya Settlement Archaeology. In *Perspectives on Ancient Maya Rural Complexity*, edited by G. Iannone and S. V. Connell, pp. 108-118. Monograph 49, Cotsen Institute of Archaeology at UCLA, Los Angeles.
- 2004 Exploring Ancient Economic Relationships at Caracol, Belize. *Research Reports in Belizean Archaeology* 1:115-127.
- 2005 Searching for Caracol's last Urbanites: Continued Investigations of Small Structures in and near Caracol's Epicenter. Season Report. Belize Institute of Archaeology. (<http://www.caracol.org/reports/2005.php>)
- 2006 Trying to Understand the End: Continued Investigations of Small Structures in and near Caracol's Epicenter. Season Report. Belize Institute of Archaeology. (<http://www.caracol.org/reports/2006.php>)
- 2007a Ancient Maya Urban Development: Insights from the Archaeology of Caracol, Belize. *Belizean Studies* 29(2):60-72.
- 2007b Late Classic Ritual Variation in a Maya Community: Continued Investigations of Structures in and near Caracol's Epicenter. Season Report. Belize Institute of Archaeology. (<http://www.caracol.org/reports/2007.php>)

- Chase, Arlen F., Diane Z. Chase, Elayne Zorn, and Wendy Teeter
 2008 Textiles and the Maya Archaeological Record. *Ancient Mesoamerica* 19(1): 127-142.
- Chase, Diane Z. and Arlen F. Chase
 1988 A Postclassic Perspective: Excavations at the Maya Site of Santa Rita Corozal, Belize. PARI Monograph 4, San Francisco.
- 1996 Maya Multiples: Individuals, Entries, and Tombs in Structure A34 of Caracol, Belize. *Latin American Antiquity* 7(1):61-79.
- 1998 The Architectural Context of Caches, Burials, and Other Ritual Activities for the Classic Period Maya (as Reflected at Caracol, Belize). In *Function and Meaning in Classic Maya Architecture*, edited by Stephen Houston, pp. 299-332. Dumbarton Oaks Research Library and Collection, Washington.
- 2004 Archaeological Perspectives on Classic Maya Social Organization from Caracol, Belize. *Ancient Mesoamerica* 15: 111-119.
- Clark, John E.
 1991 Modern Lacandon Lithic Technology and Blade Workshops. In *Maya Stone Tools: Selected Papers from the Second Maya Lithic Conference*, edited by T. R. Hester and H. J. Shafer, pp. 251-266. Prehistory Press, Madison.
- 2007 In Craft Specialization's Penumbra: Things, Persons, Action, Value, and Surplus. In *Rethinking Craft Specialization in Complex Societies: Archaeological Analyses of the Social Meaning of Production*, edited by Z. X. Hruby and R. K. Flad, pp. 20-36. Archaeological Papers of the American Anthropological Association, No. 17.
- Clark, John E. and Donne Bryant
 1991 The Production of Chert Projectile Points at Yerba Buena, Chiapas, Mexico. In *Maya Stone Tools: Selected Papers from the Second Maya Lithic Conference*, edited by T. R. Hester and H. J. Shafer, pp. 85-102. Prehistory Press, Madison.
- Clark, John E. and Stephen D. Houston
 1998 Craft Specialization, Gender, and Personhood among the Postconquest Maya of Yucatan, Mexico. *Archaeological Papers of the American Anthropological Association* 8(1): 31-46.
- Clark, John E. and William J. Parry
 1990 Craft Specialization and Cultural Complexity. *Research in Economic Anthropology* 12: 289-346.

Cobos, Rafael

- 1994 Preliminary Report on the Archaeological Mollusca and Shell Ornaments of Caracol, Belize. In *Studies in Archaeology of Caracol, Belize*, edited by D. Z. Chase and A. F. Chase, pp. 139-147. PARI Monograph 7, San Francisco.

Coe, William R.

- 1959 Piedras Negras Archaeology: Artifacts, Caches, and Burials. The University Museum, University of Pennsylvania, Philadelphia.

Costin, Cathy L.

- 1991 Craft Specialization: Issues in Defining, Documenting, and Explaining the Organization of Production. *Archaeological Method and Theory* 3:1-56.
- 2001 Craft Production Systems. In *Archaeology at the Millennium: A Sourcebook*, edited by G. M. Feinman and T. D. Price, pp. 273-327. Kluwer Academic/Plenum Publishers, New York.
- 2005 Craft Production. In *Handbook of Archaeological Methods*. edited by Herbert D. G. Maschner. AltaMira, Walnut Creek.
- 2007 Thinking about Production: Phenomenological Classification and Lexical Semantics. In *Rethinking Craft Specialization in Complex Societies: Archaeological Analyses of the Social Meaning of Production*, edited by Z. X. Hruby and R. K. Flad, pp. 143-162. Archaeological Papers of the American Anthropological Association, No. 17.

Costin, Cathy L. and Melissa B. Hagstrum

- 1995 Standardization, Labor Investment, Skill, and the Organization of Ceramic Production in late Prehistoric Highland Peru. *American Antiquity* 60(4): 619-639.

D'Altroy, Terence N. and Ronald L. Bishop

- 1990 The Provincial Organization of Inka Ceramic Production. *American Antiquity* 55(1): 120-138.

Dahlin, Bruce H and William J. Litizinger

- 1986 Old Bottle, New Wine: The Function of Chultuns in the Maya Lowlands. *American Antiquity* 51(4): 721-736.

DeMarrais, Elizabeth, L., Luis J. Castillo and Timothy Earle

- 1996 Ideology, Materialization, and Power Strategies. *Current Anthropology* 37(1):15-31.

Diehl, Richard A.

- 2004 The Olmecs: America's First Civilization. Thames and Hudson Ltd, London.

Earle, Timothy

1977 A Reappraisal of Redistribution: Complex Hawaiian Chiefdoms. In *Exchange Systems in Prehistory*, edited by T. K. Earle and J. E. Ericson, pp. 213- 232. Academic Press, New York.

2001 Economic Support of Chaco Canyon Society. *American Antiquity* 33(1):26-35.

Eaton, Jack D.

1991 Tools of Ancient Maya Builders. In *Maya Stone Tools: Selected Papers from the Second Maya Lithic Conference*, edited by T. R. Hester and H. J. Shafer, pp. 219-228. Prehistory Press, Madison.

Eerkins, Jelmer W, and Robert L. Bettinger

2001 Techniques for Assessing Standardization in Artifact Assemblages: Can We Scale Material Variability? *American Antiquity* 66(3): 493-504.

Ekholm, Gordon

1964 A Maya Sculpture in Wood. *The Museum of Primitive Art*.

Fedick, Scott

1991 Chert Tool Production and Consumption among Classic Period Maya Households. In *Maya Stone Tools: Selected Papers from the Second Maya Lithic Conference*, edited by T. R. Hester and H. J. Shafer, pp. 103-118. Prehistory Press, Madison.

Fletcher, Mike and Gary R. Lock

2005 Digging Numbers: Elementary Statistics for Archaeologists. 2nd Edition. Oxford University School of Archaeology, Monograph 33. Oxford University, Oakville.

Ford, James A., Philip Philips and William. G. Haag

1955 The Jaketown Site in West-central Mississippi. *Anthropological Papers of the American Museum of Natural History* 45(1).

Fowler, William

1991 Lithic Analysis as a Means of Processual Inference in Southern Mesoamerica: A Review of Recent Research. In *Maya Stone Tools: Selected Papers from the Second Maya Lithic Conference*, edited by T. R. Hester and H. J. Shafer, pp. 1-20. Prehistory Press, Madison.

Gibson, Eric C.

1991 A Preliminary Functional and Contextual Study of Constricted Adzes from Northern Belize. In *Maya Stone Tools: Selected Papers from the Second Maya Lithic Conference*, edited by T. R. Hester and H. J. Shafer, pp. 229-238. Prehistory Press, Madison.

Grube, Nicoli

2000 Los Mayas: Una Civilizacion Milenaria. Konwmann, Germany.

Hammond, Normand

1972 Classic Maya Music Part 1: Maya Drums. *Archaeological* 25:124-131.

1976 Maya Obsidian Trade in Southern Belize. In *Maya Lithic Studies: Papers from the 1976 Belize Field Symposium*, edited by T. R. Hester and N. Hammond, pp. 71-82. Center for Archaeological Research, The University of Texas at San Antonio.

Hanson, Richard D.

1990 Excavations in the Tigre Complex El Mirador, Petén, Guatemala. New World Archaeological Foundation No. 62. Brigham Young University, Provo.

Hayashida, Frances M.

1999 Style, Technology, and State Production: Inka Pottery Manufacture in the Leche Valley, Peru. *Latin American Antiquity* 10(4):337-352.

Hayden, Brian

1987 Lithic Studies Among the Contemporary Highland Maya. The University of Arizona Press, Tucson.

Hayden, Brian and Aubrey Canon

1983 Where the Garbage Goes: Refuse Disposal in the Maya Highlands. *Journal of Anthropological Archaeology* 2: 117-163.

Healan, Dan M.

1992 A Comment on Moholy-Nagy's "Misidentification of Lithic Workshops". *Latin American Antiquity* 3(3):240-242.

Hendon, Julia. A.

1996 Archaeological Approaches to the Organization of Domestic Labor: Household Practice and Domestic Relations. *Annual Review of Anthropology* 25:45-61.

Hester, Thomas R.

1976 Belize Lithic: Forms and Functions. In *Maya Lithic Studies: Papers from the 1976 Belize Field Symposium*, edited by T. R. Hester and N. Hammond, pp. 11-20. Center for Archaeological Research, The University of Texas at San Antonio.

Hester, Thomas R. and Normand Hammond

1976 Maya Lithic Studies: Papers from the 1976 Belize Field Symposium. Center for Archaeological Research, The University of Texas at San Antonio.

Hester, Thomas R. and Harry J. Shafer

1991 *Maya Stone Tools: Selected Papers from the Second Maya Lithic Conference.* Prehistory Press, Madison.

1992 *Lithic Workshops Revisited: Comments on Moholy-Nagy.* *Latin American Antiquity* 3(3):243-248.

Hirth, Kenneth G.

1993 *The Household as an Analytical Unit: Problems in Method and Theory.* In *Prehispanic Domestic Units in Western Mesoamerica: Studies of the Household, Compound, and Residence*, edited by R. S. Santley and K. G. Hirth, pp.21-36. CRC Press, Boca Raton.

1998 *The Distributional Approach: A New way to Identify Marketplace Exchange in the Archaeological Record.* *Current Anthropology* 39(4): 451-476.

2003 *Mesoamerican Lithic Technology: Experimentation and Interpretation.* The University of Utah Press, Salt Lake City.

Hunter-Tate, Clarissa C.

1994 *The Chultuns of Caracol, Belize.* In *Studies in Archaeology of Caracol, Belize*, edited by D. Z. Chase and A. F. Chase, pp. 64-75. PARI Monograph 7, San Francisco.

Hruby, Zachary X.

2006 *The Organization of Chipped-Stone at Piedras Negras, Guatemala.* Unpublished Dissertation. University of California Riverside.

2007 *Ritualized Chipped-Stone Production at Piedras Negras, Guatemala.* In *Rethinking Craft Specialization in Complex Societies: Archaeological Analyses of the Social Meaning of Production*, edited by Z. X. Hruby and R. K. Flad, pp. 68-87. Archaeological Papers of the American Anthropological Association, No. 17.

Inomata, Takeshi

2003 *War, Destruction, and Abandonment: The Fall of the Classic Maya Center of Aguateca, Guatemala.* In *The Archaeology of Settlement Abandonment in Middle America*, edited by T. Inomata and R. W. Webb, pp. 43-60. University of Utah Press, Salt Lake City.

Janusek, John W.

1999 *Craft and Local Power: Embedded Specialization in Tiwanaku Cities.* *Latin American Antiquity* 10(2):107-131.

- Johnson, Jay K.
1976 Long Distance Obsidian Trade: New Data from the Western Maya Periphery. In *Maya Lithic Studies: Papers from the 1976 Belize Field Symposium*, edited by T. R. Hester and N. Hammond, pp. 83-90. Center for Archaeological Research, The University of Texas at San Antonio.
- Kaneko, Akira
2003 *Artifectos Liticos de Yaxchilan*. INAH, Coleccion Cientifica, 455, Mexico.
- Kidder, Alfred V.
1947 *The Artifacts of Uaxactun, Guatemala*. Publication 576. Carnegie Institute of Washington, Washington, D.C.
- Kovacevich, Brigitte
2007 *Ritual, Crafting, and Agency at the Classic Maya Kingdom of Cancuen*. In *Mesoamerican Ritual Economy: Archaeological and Ethnological Perspectives*, edited by E. C. Wells and K. L. Davis-Salazar, pp. 67-114. University of Colorado, Boulder.
- Kvanne, Kenneth L., Miriam T. Stark, and William Longacre
1996 *Alternative Procedures for Assessing Standardization in Ceramic Assemblages*. *American Antiquity* 61(1): 116-126.
- Lee, Thomas A. Jr.
1969 *The Artifacts of Chiapa de Corzo, Chiapas, Mexico*. New World Archaeological Foundation No. 26. Brigham Young University, Provo.
- Levine, Mark
2003 *Ceramic Change and Continuity in the Lower Rio Verde Region of Oaxaca, Mexico: The Late Formative to Early Terminal Transition*. Unpublished MA Thesis. The University of Colorado, Boulder.
- Lewenstein, Suzanne
1987 *Stone Tool Use at Cerros: The Ethnoarchaeological and Use-Wear Evidence*. University of Texas Press, Austin.
- 1991a *Edge Angles and Tool Function Among the Maya: A Meaningful Relationship?* In *Maya Stone Tools: Selected Papers from the Second Maya Lithic Conference*, edited by T. R. Hester and H. J. Shafer, pp. 207-218. Prehistory Press, Madison.
- 1991b *Woodworking Tools at Cerros*. In *Maya Stone Tools: Selected Papers from the Second Maya Lithic Conference*, edited by T. R. Hester and H. J. Shafer, pp. 239-250. Prehistory Press, Madison.

Lewis, Brandon S.

- 1996 The Role of Attached and Independent Specialization in the Development of Social Complexity. *Research in Economic Anthropology* 17:357-388.

Longacre, William A., Kenneth L. Kvamme, and Masashi Kobayashi

- 1988 Southern Pottery Standardization: An Ethnoarchaeological View from the Philippine. *The Kiva* 53(2): 101-112.

Malloy, John K.

- 1986 "Workshops" and "Specialized Production" in the Production of Maya Chert Tools: A Response to Shafer and Hester. *American Antiquity* 51(1):152-158.

McAnany, Patricia A.

- 1989 Stone-Tool Production and Exchange in the Eastern Maya Lowlands: The Consumer Perspective from Pulltrouser Swamp, Belize. *American Antiquity* 54(2):332-346.

Meadows, Richard K.

- 2001 Crafting K'awil: A Comparative Analysis of Maya Symbolic Flake Stone Assemblages from Three Sites in Northern Belize. Unpublished PhD Dissertation. University of Texas at Austin.

Michels, Joseph W.

- 1976 Some Sociological Observations on Obsidian Production at Kaminaljuyu, Guatemala. In *Maya Lithic Studies: Papers from the 1976 Belize Field Symposium*, edited by T. R. Hester and N. Hammond, pp. 109-136. Center for Archaeological Research, The University of Texas at San Antonio.

Mills, Barbara J.

- 1995 Gender and the Role of Historic Zuni Craft Production: Implications for Archaeological Interpretation. *Journal of Anthropological Research* 51(2):149-172.

Mitchum, Beverly

- 1991 Lithic Artifacts from Cerros, Belize: Production, Consumption, and Trade. In *Maya Stone Tools: Selected Papers from the Second Maya Lithic Conference*, edited by T. R. Hester and H. J. Shafer, pp. 45-54. Prehistory Press, Madison.

Moholy-Nagy, Hattula

- 1976 Spatial Distribution of Flint and Obsidian Artifacts at Tikal, Guatemala. In *Maya Lithic Studies: Papers from the 1976 Belize Field Symposium*. edited by Thomas R. Hester and Norman Hammond. Center for Archaeological Research, The University of Texas at San Antonio, Belize.

- 1990 The Misidentification of Mesoamerican Lithic Workshops. *Latin American Antiquity* 1(3):268-279.
- 1997 Middens, Construction Fills, and Offerings: Evidence for the Organization of Classic Period Craft Production at Tikal, Guatemala. *Journal of Field Archaeology* 24(3): 293-313.
- 2003 The Artifacts of Tikal: Utilitarian Artifacts and Unworked Material. Tikal Report No. 27 Part B. University of Pennsylvania Museum.
- Peacock, D. P. S.
1982 Pottery in the Roman World: An Ethnoarchaeological Approach. Longman, London.
- Polanyi, Karl
1957 The Economics as Instituted Process. In *Trade and Markets in the Early Empires: Economics in History and Theory*, edited by K. Polanyi, C. M. Arensberg, and H. W. Pearson, pp. 243-269. The Free Press, New York.
- Pope, Cynthia
1994 Preliminary Analysis of Small Chert Tools and Related Debitage at Caracol, Belize. In *Studies in the Archaeology of Caracol, Belize*, edited by D. Z. Chase and A. F. Chase, pp. 148-156. PARI Monograph 7, San Francisco.
- Pope Jones, Cynthia.
1996 Small Chert Tools and Debitage from Craft Areas at the Maya Site of Caracol, Belize. Unpublished MA Thesis, University of Texas Austin.
- Potter, Daniel R.
1991 A Descriptive Taxonomy of Middle Preclassic Chert Tools at Colha, Belize. In *Maya Stone Tools: Selected Papers from the Second Maya Lithic Conference*, edited by T. R. Hester and H. J. Shafer, pp. 21-30. Prehistory Press, Madison.
- Proskouriakoff, T.
1962 The Artifacts from Mayapan. In *Mayapan, Yucatan, Mexico*, edited by H. E. D. Polluck, R. L. Roys, T. Proskourikoff and A. L. Smith, pp. 87-169, Publication 619. Carnegie Institute of Washington, Washington, D.C.
- Puleston, Dennis
1971 An Experimental Approach to the Function of Classic Maya Chultuns. *American Antiquity* 36(3): 322-335.
- Puleston, Olga. S.
1969 Functional Analysis of a Workshop Tool Kit from Tikal. Unpublished MA Thesis, University of Pennsylvania.

- Ricketson, Oliver G. and Edith B. Ricketson
 1937 Uaxactun, Guatemala Group E, 1923-1931. CIW Publication 477. Carnegie Institute of Washington, Washington, D.C.
- Roux, Valentine
 2003 Ceramic Standardization and Intensity of Production: Quantifying Degrees of Specialization. *American Antiquity* 68(4):768-782.
- Rovner, Irwin
 1976 Pre-Columbian Maya Developments of Utilitarian Lithic Industries: The Broad Perspective from Yucatan. In *Maya Lithic Studies: Papers from the 1976 Belize Field Symposium*, edited by T. R. Hester and N. Hammond, pp. 41-54. Center for Archaeological Research, The University of Texas at San Antonio.
- Santone, Lenore
 1997 Transport Costs, Consumer Demand, and Patterns of Intraregional Exchange: A Perspective on Commodity Production from Northern Belize. *Latin American Antiquity* 8(1):71-88.
- Saville, Marshall H.
 1925 The Wood-Carver's Art in Ancient Mexico. Pandick Press, New York City.
- Schortman, Edward M. and Patricia. A. Urban
 2004 Modeling the Roles of Craft Production in Ancient Political Economies. *Journal of Archaeological Research* 12(2):185-226.
- Shafer, Harry J.
 1976 Belize, Lithics: "Orange Peel" Flakes and Adze Manufacture. In *Maya Lithic Studies: Papers from the 1976 Belize Field Symposium*, edited by T. R. Hester and N. Hammond, pp. 21-34. Center for Archaeological Research, The University of Texas at San Antonio.
 1991 Late Preclassic Formal Stone Tool Production at Colha, Belize. In *Maya Stone Tools: Selected Papers from the Second Maya Lithic Conference*, edited by T. R. Hester and H. J. Shafer, pp. 31-44. Prehistory Press, Madison.
- Shafer, Harry J. and Thomas R. Hester
 1983 Ancient Maya Chert Workshops in Northern Belize, Central America. *American Antiquity* 48(3):519-543.
 1986 Maya Stone-Tool Craft Specialization and Production at Colha, Belize: Reply to Mallory. *American Antiquity* 51(1):158-166.

- 1988 Appendix III: Preliminary Analysis of Postclassic Lithic. In *A Postclassic Perspective: Excavations at the Maya Site of Santa Rita Corozal, Belize*. PARI Monograph 4, San Francisco.
- 1991 Lithic Craft Specialization and Product Distribution at the Maya Site of Colha, Belize. *World Archaeology* 23(1):79-97.
- Sharer, Robert J. and Wendy Ashmore
2003 *Archaeology: Discovering Our Past*. McGraw Hill, Boston.
- Sheets, Payson D.
1976 Islands of Knowledge Amid Sea of Ignorance in the Maya Area. In *Maya Lithic Studies: Papers from the 1976 Belize Field Symposium*, edited by T. R. Hester and N. Hammond, pp. 1-10. Center of Archaeological Research, The University of Texas at San Antonio.
- 1977 The Analysis of Chipped Stone Artifacts in Southern Mesoamerica: An Assessment. *Latin American Antiquity* 12(1):139-158.
- 1978 The Artifacts of Chalchuapa. In *The Prehistory of Chalchuapa, El Salvador, Volume Two: Artifacts and Figurines*, edited by R. Sharer, pp. 2-133. University of Pennsylvania Press, Philadelphia.
- 1991 Flaked Lithics from the Cenote of Sacrifice, Chichen Itza, Yucatan. In *Maya Stone Tools: Selected Papers from the Second Maya Lithic Conference*, edited by T. R. Hester and H. J. Shafer, pp. 163-188. Prehistory Press, Madison.
- Schiffer, Michael B.
1972 Archaeological Context and Systemic Context. *American Antiquity* 37(2): 156-165
- Sinopoli, Carla M.
1988 The Organization of Craft Production at Vijayanagara, South India. *American Antiquity* 90(3):580-597.
- Spaulding, Albert C.
1953 Statistical Techniques for the Discovery of Artifact Types. *American Antiquity* 18(4): 315-313.
- Santley, Robert S. and Ronald R. Kneebone
1993 Craft Specialization, Refuse Disposal, and the Creation of Spatial Archaeological Records in Prehispanic Mesoamerica. In *Prehispanic Domestic Units in Western Mesoamerica: Studies of the Household, Compound, and Residence*, edited by R. S. Santley and K. G. Hirth, pp.37-66. CRC Press, Boca Raton.

Stoltman, James B.

- 1978 Lithic Artifacts from a Complex Society: The Chipped Stone Tools of Becan, Campeche, Mexico. In *Occasional Paper 2: Middle America Research Institute Tulane University*, pp. 1-30. Tulane University, New Orleans.

Masakazu, Tani

- 1995 Beyond the Identification of Formation Processes: Behavioral Inference Based on Traces Left by Cultural Formation Processes. *Journal of Archaeological Method and Theory* 2(3): 231-252.

Taschek, Jennifer T.

- 1994 The Artifacts of Dzibilchaltun, Yucatan, Mexico: Shell, Polished Stone, Bone, Wood, and Ceramics. Middle American Research Institute: Publication 50, New Orleans.

Teeter, Wendy Giddens

- 2001 Maya Diet in a Changing Urban Environment: Faunal Utilization at Caracol, Belize. Unpublished Ph.D. Dissertation. University of California Los Angeles.

Thompson, Marc

- 1991 Flaked Celt Production at Becan, Campeche, Mexico. In *Maya Stone Tools: Selected Papers from the Second Maya Lithic Conference*, edited by T. R. Hester and H. J. Shafer, pp. 143-154. Prehistory Press, Madison.

Titmus Gene L. and John E. Clark

- 2003 *Mexica* Blade Making and Wooden Tools: Recent Experimental Insights. In *Mesoamerican Lithic Technology: Experimentation and Interpretation*, edited by K. G. Hirth, pp. 72-97. The University of Utah Press, Salt Lake City

Torrence, Robin

- 1986 Production and Exchange of Stone Tools: Prehistoric Obsidian in the Aegean. Cambridge University Press, New York.

Van der Louw, S. E.

- 1976 Studies in the Technology of Ancient Pottery. *Organization for the Advancement of Pure Research*. Amsterdam.

VanPool, Todd L. and Robert D. Leonard

- 2002 Specialized Ground Stone Production in the Casas Grandes Region of Northern Chihuahua. *American Antiquity* 67(4): 710-730.

Vaughn, Kevin J.

- 2006 Craft Production, Exchange, and Political Power in the Pre-Incaic Andes. *Journal of Archaeological Research* 14:313-344.

Wailes, Bernard

- 1996 Craft Specialization and Social Evolution: In *Memory of V. Gordon Childe. University Museum Symposium Series, Vol. VI*. University of Pennsylvania, Philadelphia.

Wells, Peter S.

- 1996 Location, Organization, and Specialization of Craft Production in Late Prehistoric Central Europe. In *Memory of V. Gordon Childe. University Museum Symposium Series, Vol. VI*, edited by B. Wailes, pp. 85-98. University of Pennsylvania, Philadelphia.

Willey, Gordon R.

- 1972 The Artifacts of Altar de Sacrificios. *Papers of the Peabody Museum of Archaeology and Ethnology* 64(1).

Willey, Gordon R., William R. Bullard, John B. Glass and James C. Gifford

- 1965 Prehistoric Maya Settlement Patterns in the Belize Valley. Peabody Museum, Cambridge.

Wilk, Richard

- 1976 Work in Progress at Colha, Belize. In *Maya Lithic Studies: Papers from the 1976 Belize Field Symposium*, edited by T. R. Hester and N. Hammond, pp. 35-40. Center for Archaeological Research, The University of Texas at San Antonio.

Wilson, Douglas C.

- 1994 Identification and Assessment of Secondary Refuse Aggregates. *Journal of Archaeological Method and Theory* 1(1): 41- 68