

PRACTICAL USE OF GROUND PENETRATING RADAR:
A SURVEY OF COASTAL HISTORIC CEMETERIES IN FLORIDA

by

WILLIAM P. BOYNTON
A.A. South Florida State College 2004
B.A. University of South Florida, 2006

A thesis submitted in partial fulfillment of the requirements
for the degree of Master of Arts
in the Department of Anthropology
in the College of Sciences
at the University of Central Florida
Orlando, Florida

Spring Term
2015

Major Professor: Sarah B. Barber

ABSTRACT

Ground Penetrating Radar (GPR) research conducted in coastal environments is one area that is lacking in archaeology. Surveys conducted in this type of environment afford the opportunity to evaluate the practical use GPR under field conditions. Coastal environments are effective for this evaluation because they offer a host of conditions that GPR surveys do not normally encounter at one time. The relationship of the land to the coast, sub-surface conditions and reliable survey areas create a “perfect storm” to test how practical the use of GPR is in coastal environments.

This research is a study of homestead cemeteries situated within the boundaries of Cape Canaveral Air Force Station (CCAFS), using GPR. The research has three main goals. The first is to utilize GPR to identify if there are any unknown burials at CCAFS. The second is to test the practical effectiveness of GPR in coastal environments where high water table, geology and saline conditions can limit the capability of the technique to resolve subsurface features. The third is to correlate data from the GPR survey with ethnographic information to enhance the protection and maintenance with what is already available for the cemeteries.

Research methods include field-based geophysical data collection in addition to archival and ethnographic historic research. The field component, to which this research pertains, entailed an on-site GPR survey at the nine sites on Cape Canaveral Air Force Station. This was followed by analysis of the information from the survey using standard processing software. Subsequently, a thorough archival search was completed to link historic and ethnographic

information with the archaeological data obtained on the cemeteries. The final result of this research was a report that provides a detailed description of the results of the GPR survey of the cemeteries at Cape Canaveral Air Force Station.

ACKNOWLEDGMENTS

This research project did not just materialize out of thin air. There are many people that have helped in a multitude of ways to get this project finished. Besides those of my academic committee, who I owe a special debt for their patience and understanding, my family and friends should also be acknowledged for their ability to direct and force me to maintain my focus on the task at hand. In particular I was special debt to my partner, Ray Gill, who encouraged me to continue and stay the course when at times this thesis seemed a bit much. Many thanks also go to my sister Roberta for her ability to see the structure in writing much better than I ever could as I wrote this thesis and her ability to step back and let me learn from my mistakes. Appreciation always to Deb and Carmen a kindred souls who have found their dreams and let me flop over the academic two years at Central Florida, Deb Ziel. Finally a special thanks to my dad who just thought I could and encouraged me to do.

Special thanks must be given to my committee chair Dr. Sarah Barber for the help in doing the physical research at Cape Canaveral and for the insightful direction that is manifest in the final form of this thesis. I want to thank particular, the committee members, Dr. John J. Schultz and Dr. Robert V. Cassanello, for their time and effort in review my thesis. One final thank you to the base historical preservation officer at Cape Canaveral Air Force station, Thomas E. Penders, whose help, resources and information were invaluable in undertaking and completing this research

TABLE OF CONTENTS

LIST OF FIGURES	viii
LIST OF TABLES	xii
CHAPTER 1: INTRODUCTION	1
Cemetery Studies	2
Ground Penetrating Radar (GPR)	3
Cemetery GPR at Cape Canaveral Air Force Station	4
CHAPTER 2: BACKGROUND	8
Previous Research on Historic Cemeteries	8
Historic Cemeteries: Studies Conducted using GPR	12
Principles of GPR	15
GPR Processing	17
GPR Research at Cape Canaveral	19
Geography of Cape Canaveral	20
Environmental Conditions at Cape Canaveral	21
Cape Canaveral: Sedimentology	22
Hydrology of Cape Canaveral	23
Flora of Cape Canaveral	24
Climate of Cape Canaveral	25
CHAPTER 3: METHODOLOGY	27
Introduction	27
History of Cape Canaveral	27
Early Settlement	27
Cape Canaveral Homesteaders	29
Cape Canaveral Development in the 20th Century	30
Historic Cemeteries on Cape Canaveral	31
Ground Penetrating Radar Methodology	36
Site Selection	36
Survey Equipment	37
Chronology of Survey	39
Field Methods	39

Survey Challenges	40
CHAPTER 4: PHYSICAL DESCRIPTION OF THE CEMETERIES	42
Cape Road Cemetery	42
Physical Characteristics	43
Cape Road Cemetery Grid 2	44
Quarterman Homestead Cemeteries	46
Quarterman South Cemetery	46
Quarterman South Grid 2	47
Quarterman South Grid 3	48
Quarterman North Cemetery	48
Quarterman North Cemetery Grid 1	49
Quarterman North Cemetery Grid 2	49
Burnham Cemetery	50
Burnham Cemetery Grids Large and Small	51
Additional Cemeteries and Burial Plots.....	52
CHAPTER 5: ANALYSIS	54
Post-Acquisition Processing	55
Ground Penetrating Radar Reflection Profiles	56
Reflection Profile Point Plot Mapping.....	58
Cape Road Cemetery	60
Cape Road Cemetery Grid 2	65
Quarterman Cemetery South	67
Quarterman Cemetery North	70
Burnham Cemetery	72
Discussion.....	76
CHAPTER 6: CONCLUSION	83
APPENDIX A: FIGURES	86
APPENDIX B: CALIBRATION DAY 1 CAPE ROAD CEMETERY	139
APPENDIX C: CALIBRATION DAY 2 CAPE ROAD CEMETERY	142
APPENDIX D: CAPE ROAD CEMETRY GRID 2, .50 M.....	145

APPENDIX E: CAPE ROAD CEMETERY GRID 2, .25 M.....	148
APPENDIX F: QUARTERMAN SOTH CEMETERY GRID 1	151
APPENDIX G: QUARTERMAN SOUTH GRID 2	154
APPENDIX H: QUARTERMAN SOUTH GRID 3	157
APPENDIX I: QUARTERMAN NORTH CEMETERY.....	160
APPENDIX J: BURNHAM CEMTERY GRID 1	163
APPENDIX K: BURNHAM CEMETERY GRID 2	166
APPENDIX L: TABLES	169
APPENDIX M: POINT PLOT TABLES AND MAPS.....	183
APPENDIX N: GENEALOGY OF CEMETERIES ON CCAFS	208
APPENDIX O: DATA COLLECTION AND PROCESSING ISSUES, CCAFS	215
REFERENCES	219

LIST OF FIGURES

Figure 1 Cape Canaveral Satellite Image. source; www.nps.goc 2014	87
Figure 2 Cape Canaveral Air Force Station Sub-surface Soil	88
Figure 3. Soil Type USDA UFDL Map.....	89
Figure 4 Cape Canaveral Cape Road Cemetery source; Google Map 2014.....	90
Figure 5 Mills O. Burnham. source; Brevard Historical Society.....	91
Figure 6 Legacy 8.0 Screen Shot of Burnham family Genealogy, source; Legacy 8.....	91
Figure 7 1840 United States Census Burnham Family; source; www.ancestry.com	92
Figure 8 Muster/Death notice Mills O Burnham Jr., source; www.fold3.com.....	93
Figure 9 Muster November 1862, Mills O. Burnham Jr., source; www.fold3.com	94
Figure 10 Mills O. Burnham Jr. Personal Effects, source; www.fold3.com	95
Figure 11 Possible Mills O. Burnham Jr. headstone, source; www.oaklandcemeteryburials.com	96
Figure 12 Slave Manifest related to Mills O. Burnham Sr., source; www.ancestry.com.....	97
Figure 13 Cape Road Cemetery 1943, source; Thomas E. Penders, 45 SW Cultural Resource Manager	98
Figure 14 Cape Road Cemetery Grid 2, source; Google Earth.....	99
Figure 15 Cape Road Cemetery Map, source; W. Boynton	100
Figure 16 CRC Grid 2 Map, source: W. Boynton	101
Figure 17 Quarterman South Grid Maps, source; W. Boynton	102
Figure 18 Quarterman South Cemetery, source; Thomas E. Penders, 45 SW Cultural Resource Manager	103
Figure 19 Quarterman South Cemetery, source; Thomas E. Penders, 45 SW Cultural Resource Manager	104

Figure 20 Quarterman South Cemetery headstones, source; Thomas E. Pender, 45 SW Cultural Resource Manager	105
Figure 21 Quarterman South Cemetery Grid 2, source; Thomas E. Pender, 45 SW Cultural Resource Manager	105
Figure 22 Quarterman South Cemetery Grid 3, source; Thomas E. Penders 45 SW Cultural Resource Manager	106
Figure 23 Quarterman North Cemetery, source; Thomas E. Penders 45 SW Cultural Resource Manager	107
Figure 24 Quarterman North Grid Maps, source; W. Boynton	108
Figure 25 Burnham Family Cemetery, source; Thomas E. Penders, 45 SW Cultural Resource Manager	109
Figure 26 Burnham Family Cemetery Map, source; W. Boynton.....	110
Figure 27 Burnham Cemetery North enclosure, source; Thomas Penders, 45 SW Cultural Resource Manager	111
Figure 28 Burnham Cemetery North perspective, source; Thomas E. Penders, 45 SW Cultural Resource Manager	112
Figure 29 Burnham Cemetery Southwest corner, source; Thomas E. Penders, 45 SW Cultural Resource Manager	113
Figure 30 Calibration Pipe Cape Road Cemetery, source; GPRSoft® Pro Version 2.6.4	114
Figure 31 Tank Void, source; http://www.envirophysics.com/GPR.html	114
Figure 32 Example Point Plot Map Burnham Family Cemetery, source; W Boynton.....	115
Figure 33 Cape Road Cemetery, Day 2, Transect 71, source; GPRSoft® Pro Version 2.6.4	116
Figure 34 CRC Anomalous Features Map, source; W. Boynton.....	117
Figure 35 Cape Road Cemetery, Day 2, Transect 68, source; GPRSoft® Pro Version 2.6.4	118
Figure 36 Cape Road Cemetery, Day 2, Transect 39, source; GPRSoft® Pro Version 2.6.4	118
Figure 37 Cape Road Cemetery Transect 8 Day 1, source; GPRSoft® Pro Version 2.6.4	119
Figure 38 Cape Road Cemetery, Day 2, Transect 23, source; GPRSoft® Pro Version 2.6.4	119

Figure 39 Cape Road Cemetery, Day 2, Transect 57, source; GPRSoft® Pro Version 2.6.4	120
Figure 40 Cape Road Cemetery Grid 2 Anomaly Map, source; W. Boynton	121
Figure 41 Cape Road Cemetery Grid 2 Transect 21, source; GPRSoft® Pro Version 2.6.4	122
Figure 42 Cape Road Cemetery Grid 2 Transect 54, source; GPRSoft® Pro Version 2.6.4	122
Figure 43 Cape Road Cemetery Grid 2 Transect 92, source; GPRSoft® Pro Version 2.6.4	123
Figure 44 CRC G2 C transect 53, source; GPRSoft® Pro Version 2.6.4.....	123
Figure 45 CRC G2 D transect 59, source; GPRSoft® Pro Version 2.6.4.....	124
Figure 46 Quarterman South Grids 1, 2 and 3 Anomalous Maps, source; W. Boynton.....	125
Figure 47 Quarterman South Grid 1, Transect 13, source; GPRSoft® Pro Version 2.6.4	126
Figure 48 Quarterman South Grid 1, Transect 25, source: GPRSoft.....	126
Figure 49 Quarterman South Grid 1 Transect 21, source; GPRSoft® Pro Version 2.6.4	127
Figure 50 Quarterman South Grid 1, Transect 2, source GPRSoft® Pro Version 2.6.4	127
Figure 51 Quarterman South Grid 2, Transect 11, source; GPRSoft® Pro Version 2.6.4	128
Figure 52 Quarterman South, Grid 2, Transect 2, source; GPRSoft® Pro Version 2.6.4	128
Figure 53 Quarterman South Grid 2, Transect 8, source; GPRSoft® Pro Version 2.6.4	129
Figure 54 Quarterman South Grid 3, transect 29, source; GPRSoft® Pro Version 2.6.4.....	129
Figure 55 Quarterman North Grid 1 and 2 Anomaly Maps, source W. Boynton.....	130
Figure 56 Quarterman North Grid 1 Transect 7, source; GPRSoft® Pro Version 2.6.4	131
Figure 57 Quarterman North Grid 2, transect 10, source; GPRSoft® Pro Version 2.6.4.....	131
Figure 58 Burnham Family Cemetery Anomaly Map, W. Boynton.....	132
Figure 59 M. O. Burnham Burial Site, source; Thomas E. Pender 45 SW Cultural Resource Manager	133
Figure 60 Burnham Family Cemetery, transect 11, source; GPRSoft® Pro Version 2.6.4.....	134
Figure 61 Burnham Family Cemetery, Transect 13, source; GPRSoft® Pro Version 2.6.4	134

Figure 62 Burnham Family Burial Southeastern View Source; Thomas E. Pender 45 SW Cultural Resource Manager 135

Figure 63 Burnham Family Cemetery, Transect 14, source; GPRSoft® Pro Version 2.6.4 136

Figure 64 Burnham Family Cemetery, Transect 27, source: GPRSoft® Pro Version 2.6.4 136

Figure 65 Burnham Family Cemetery, Transect 7, source; GPRSoft® Pro Version 2.6.4 137

Figure 66 Burnham Family Cemetery, Transect 39, source; GPRSoft® Pro Version 2.6.4 137

Figure 67 Burnham Family Cemetery, Transect 29, source; GPRSoft® Pro Version 2.6.4 138

Figure 68 Burnham Family Cemetery, Transect 41, source; GPRSoft® Pro Version 2.6.4 138

LIST OF TABLES

Table 1 Cape Road Cemetery Burial Summary.....	170
Table 2 Cape Road Cemetery Feature Characteristics	173
Table 3 Cape Road Cemetery Grid 2 Feature Characteristics	174
Table 4 Quarterman South Cemetery, Grid 2 and Grid3	175
Table 5 Quarterman South Cemetery Grid 1, Grid 2, Grid 3 Feature Characteristics.....	176
Table 6 Quarterman North Cemetery	177
Table 7 Burnham Family Cemetery Summary	178
Table 8 Burnham Family Cemetery Feature Characteristics	179
Table 9 Summary of CCAFS Anomalous Features	180

CHAPTER 1: INTRODUCTION

A historic cemetery is a valuable resource for archaeological research. It offers insight into to community history and development over time. But historic cemeteries are fragile archaeological sites that if not fully documented and maintained will lose much of their ethnographic value. Historic cemeteries offer both a link to the past and a focal point for community identity (Rainville 2009; Sattenspiel et al. 2010); they provide a starting point for individuals to find their place in the past. But a number of issues can impact the cemetery. Development in a community, changes in society's attitudes and neglect can have an effect on the cemetery (Dunnavant 2012; Hodge et al. 2006; Kersel and Luke 2009; Olexa et al. 2012; Stokes 1991). Monuments can be moved or destroyed. If the elements of the cemetery are not recorded, both personal and communal histories are lost. What is present on the surface of a cemetery is by no means its full use history.

Cape Canaveral Air Force Station (CCAFS) is home to seven historic cemeteries that have a period of use that spans 140+ years (Cantley et al. 1994; Levy et al. 1984). Located on the east coast of Florida in Brevard County, the cemeteries are maintained by the United States Air Force.

The purpose of the survey conducted for this research is to provide a baseline for future maintenance, curation, and management of CCAFS cemeteries. Three questions will be addressed in this study. The first question is: do burials marked by headstones actually have interments? The second question is: can remote sensing technology determine if there are

unmarked or unrecorded burials in the survey's cemeteries? The third, and final, question is: can the specific characteristics of the cemeteries provide insight for the lack of interments under headstones and the locations for unknown burials? To accomplish this, finding a tool that provides cultural resource managers with information while at the same time preserving and maintaining the sanctity of the historic cemetery is beneficial (Bevan and Kenyon 1975; Conyers 2010).

Ground Penetrating Radar (GPR) offers the benefit of geophysical survey that does not directly impact the protected site but can provide revealing sub-surface images that are of interest to researchers (Conyers 2006a; 2006b). GPR can detect geophysical features, in this case unrecorded burials, which have no corresponding artifact signature on the surface of the cemetery. The location, natural conditions and age of the historic cemetery can impact the research results, but the non-invasive technique of geophysical survey and in particular GPR offers a method to identify whether unrecorded burials are present.

Cemetery Studies

A cemetery's primary function is the interment of individuals that have died. The cemetery creates a series of punctuated "pictures" of a culture through time. These "pictures" offer the archaeologist the means to document societal events, substantiate both personal and cultural histories while at the same time providing guidelines for the management, maintenance and protection of the cemetery. Studies of cemeteries were conducted that verified historical

accounts of burials of individuals (Baker 2000; Dowd 1980; Heisey 1962; King 1979; Owsley 2006). Cultural events as indicated by artifactual cemetery remains were the focus of other studies (Baker 2000; Connolly 2010; Mainfort 1985). Other studies that investigated disease and health of the interred individuals in historic cemeteries were conducted (Buzon et al. 2005; Stevens 2006). Finally studies that provided guidelines and justifications for cemetery management were conducted that provided for the maintenance and protection of this cultural resource (Dickens 1979; Orr 2006; Ubelaker 1995). The studies mentioned also corresponded with the advent and development of Ground Penetrating Radar as a tool for archaeological prospection and its subsequent mainstream use in archaeology (Bevan 1991; Bevan and Kenyon 1975; Conyers 2006a).

Ground Penetrating Radar (GPR)

Ground Penetrating Radar (GPR) was developed for use in studies of geophysical subsurface features (Bevan and Kenyon 1975). Though originally used in the European and American public sector during the mid- twentieth century, GPR moved from a tool used solely by governments to the private sector (Bevan 1991; 2008). The use of Ground Penetrating Radar (GPR) to conduct surveys has been a staple of archaeological research since the mid-1970s (Bevan and Kenyon 1975; Doolittle and Collins 1994). The original application of GPR was the detection of differences in soil strata. It was found that each type of soil generates a different wave reflection when using GPR (Conyers 2013; Conyers 2012). These reflections also indicate that subsurface features can contrast with the surrounding soil and give a picture of the total

subsurface topography (Conyers 2012). This aspect of GPR is of particular interest to archaeologists because it became possible to detect potential excavation sites in advance of actual excavation.

The non-invasive attributes of GPR were well-suited to conducting the survey at Cape Canaveral Air Force Station (CCAFS). The need to determine sub-surface conditions of the historic cemeteries while preserving the integrity of those sites were twin fundamental goals for the survey at the Cape. The decision to use GPR is reinforced by a number of previous studies that provided relevant background to the proposed study (Bevan 1991; Conyers 2006a; Thompson et al. 2004; Weaver 2006). GPR research by Bevan (1991) and Conyers (2006a) had revealed the types of subsurface profiles that commonly appear in historic cemeteries. Their research indicated that various methods used to bury individuals leave traces identifiable with GPR. GPR can remotely sense voids in the sub-surface created by vaults and partially collapsed caskets to construct a non-invasive picture of the subsurface (Sutton 2013). Metal parts of caskets return reflections indicating potential graves in addition to changes in soil consistency due to burial and decomposition processes, and also can give reflections that GPR can sense (Bevan 1991; Conyers 2006a).

Cemetery GPR at Cape Canaveral Air Force Station

The cemeteries at CCAFS offer numerous physical characteristics conducive to the use of GPR. Conditions on the ground, in the ground, the presence or lack of conductible material distributed in situ, the age of the material, in addition to the GPR itself, can impact the data

recovered in a number of ways (Meats 1996; Nuzzo 2005). Conditions including sandy soils enable excellent wave penetration with GPR and show distinctive soil stratigraphy in addition to disturbances and cuts within the soil that are indicators of human activities (Schultz and Martin 2012; Schultz and Martin 2011). The majority of the cemeteries are located on the west side of the peninsula so there is limited exposure to salt intrusions thus increasing the probability of success using GPR in this environment

Local sediments are sandy and uniform, and thus ideal for GPR (Huckle et al. 1971; Schmaizer and Hinkle 1990). The cemeteries' location on a coastal peninsula, however, is unusual due to the potential for soil salinity and an elevated water table. There are potentially three different burial practices evident in the cemeteries on Cape Canaveral (Cantley et al. 1994; Levy et al. 1984). The first is the use of vaults at the cemeteries, which the GPR survey will show as void areas in the subsurface. The second is single casket burials that GPR could record as changes in the stratigraphy of the subsurface. Finally, the possibility exists for burials in cloth or canvas materials that may or may not have ferrous compounds that GPR will pick up in the survey. Burial method coupled with the culturally significant east-west alignment of graves gives a predictable pattern for each cemetery that should facilitate the GPR survey and post-processing. This combination of conditions provides a starting framework for conducting a GPR survey.

It should be noted that although the existing conditions are conducive to the use of GPR, the CCAFS site has issues that will impact the survey in a negative way. The proximity of the

cemeteries to the Atlantic Ocean and the Banana River can affect the GPR reflections transmitted through the sub-surface to the receiving antenna. Depending on the level of the ground water in relation to the bottom of the burials and the ground surface, the reflections transmitted to the GPR unit can indicate a change of the dielectric constant in the substrate which in turn gives a false reading to a change of stratigraphic boundary or feature depth (Conyers 2013:27).

Also of note is the additional issue that salt water has on reflections generated by the GPR (Neal 2004; Schmelzbach et al. 2011). If there are intrusions of sea water in the substrate, the salt suspended in that water or in the soil has a attenuation effect on the electromagnetic wave generated by the GPR (Conyers 2012:104-106; Conyers 2013:53-54). This can change how the wave travels from the transmitter to boundaries of stratigraphic levels or features and back to the receiver. A worst case scenario would be that salt would hamper propagation and reception of a reflection to the GPR through the soil (Conyers 2012: 104-106; Conyers 2013:53-54). This would render any GPR survey conducted ineffectual and the data recovered highly suspect.

Soil conditions are not the only considerations for planning and conducting a GPR survey; any bioturbation, both faunal and floral, impacts reflectivity and feature placement in the survey. The distinctive inverted parabola created by anomalies in the profile makes differentiation of subsurface features from bioactivity difficult but essential to interpret while conducting a GPR survey (Conyers 2012:140-142). Faunal intrusions in the form of rodent runs can mix the soils and move artifacts up or down the soil column. In this case the GPR can record

geophysical targets but their depth in the soil column is suspect because of the bioturbation related to the burial. In the particular case of CCAFS, after conducting a pedestrian survey, there is only one cemetery with limited bioturbation activities. Based on the aforementioned pedestrian survey the remaining cemeteries have some sort of bioturbation action in or around the fenced cemetery boundaries.

While these limitations have the most impact on a GPR survey conducted at CCAFS, they also have an impact in any environment that GPR is used; they have the ability to change what the GPR receives as reflection profiles. In the course of conducting a survey understanding the type of environmental agencies at work on a archaeological site allows for mitigation during the GPR survey as well as during the post process analysis to obtain meaningful data. The ways the aforementioned environmental agencies impact the use of GPR, their effect of survey results and the measures taken to mitigate them will be discussed in the next chapter (Chapter 2). Following that chapter there will follow, in order, discussions of survey and research methodology (Chapter 3) as well as physical descriptions and characteristics of each cemetery and grid surveyed (Chapter 4). The final two chapters of this thesis will address the analysis, findings (Chapter 5) and conclusions of the GPR survey conducted at CCAFS (Chapter 6).

CHAPTER 2: BACKGROUND

The goal of this thesis is to locate unknown burials. Cape Canaveral offers an ideal setting in which to conduct research of this nature because the cemeteries have been protected and maintained by the military. The cemeteries are historic and thus have a known provenience. The various agencies such as climate, geology and human activity that shaped the Cape and the cemeteries themselves will be established as well as a current picture of CCAFS. This chapter also establishes the impact present conditions at the cemeteries have on conducting the GPR survey, and the historical value of GPR methodology, cemetery research, and the Cape itself.

Previous Research on Historic Cemeteries

Cemeteries are junctions where life ends and grief begins to heal. Families bury their loved ones to sustain their connection with the departed. This loving last act is performed by relatives to ensure the continuity of the memory of the departed. Cemeteries also provide a community with a symbolic means to honor the lives of their esteemed deceased citizens (Dunnavant 2012; Feldman 2007; Hay 2011; Kersel and Luke 2009; Orr 1990).

Funerary architecture, burial paraphernalia and interment practices are present in cemeteries that provide cultural insight to a community. The cemetery is a snapshot taken of a society at the time of each burial, reflective of the prevailing attitudes of the living. But the cemetery is also a delicate resource that once abandoned will begin to deteriorate and eventually become lost to the community it previously served. The cemetery offers the archaeologist an

opportunity for research. The systematic study of the characteristics of a cemetery provides information to manage, preserve and direct research of the site in a meaningful way.

In the 1960s, a series of surveys were conducted by Edwin Dethlefsen and James Deetz (1966) for the purpose of documenting the architecture and motifs of 18th and 19th century headstones in a colonial cemetery located in New England. Dethlefsen and Deetz (1966:40-41) postulated that information regarding death, disease and mortuary imagery was available based on the headstones' demographic information. The initial survey of the headstones recorded stylistic changes over time. It also revealed to Dethlefsen and Deetz (1967) that demographic information on headstones offered specific information that was of value to archaeologists; the engravings on the headstones provided information such as paternity, gender, and mortality rates. The team concluded that a headstone's statistical information was not only useful in documenting the demography of a specific community in New England, but the methodology could also be applied to any cemetery using burial markers (Dethlefsen and Deetz 1967). While Dethlefsen and Deetz provided insight to communities based exclusively on the documentation of mortuary architecture, the methodology of later investigations of historic cemeteries expanded to include physical and rescue archaeology.

The current state of a cemetery's preservation dictates the research question(s) and the appropriate methodology. As will be shown, documentary surveys are conducted in active burial grounds, however, a survey is not the only way cemetery research is accomplished. Motivation for research occurs when a cemetery falls into disuse and is "rediscovered," or when construction and the need for development in a community may potentially encroach on a suspected burial

ground. The results of such research reveal the necessary steps to ensure the protection, preservation, and management of the cemetery.

A number of early surveys of historic cemeteries in the United States offered demographic and cultural information. The purpose of each survey was specific to a research question or a cultural resource management goal. For example, a survey conducted in the Susquehanna Valley in central Pennsylvania revealed three previously unknown cemeteries as well as the burial practices of the Susquehannocks (Heisey 1967). The Susquehannocks lived during the period of European contact between the late 16th through the 17th centuries. The burial goods noted by Heisey evidenced the extent of trade contact between this tribe and the Monongahela tribes of eastern Ohio. He observed, as well, that the Susquehannocks buried lavish and important gifts with their dead. Following the practice of burying these prized items with the owner Heisey (1962:129-130) offered the summation that this practice removed a valuable tool for defense of the tribe and should be considered when explaining the disappearance of the community.

Another historic cemetery survey was conducted in Atlanta at Georgia's Oakland Cemetery, subsequent to the development of a plan to open areas of the cemetery that were not part of the original burial site (Dickens and Blakely 1978). The survey was conducted for the management authority of the cemetery and in accordance with guidelines of the National Historic Preservation Act (NHPA) of 1966 (Dickens and Blakely 1978). Through extensive historic document research, Dickens and Blakely theorized that the area they were about to survey was related to pauper burials performed between 1866 and 1884. In order for them to

confirm the historic records and eyewitness accounts pertinent to Oakland Cemetery, Dickens and Blakely used a mechanical road grader to remove the overburden in the survey area. What they found confirmed that the cemetery area had a larger volume of burials than anticipated had the area been used in the traditional pattern represented by the rest of the cemetery (Dickens and Blakely 1978).

Surveys to manage and protect individual burials have also been conducted. These surveys focused on more specific questions and end results such as protection from vandalism and corroboration of identity. One example is the 1979 survey conducted by Diane King on the purported burial site, in Tennessee, of a historic Cherokee chief. King sought to confirm, using both historic documentation and archaeological artifacts found in the graves, that one of three burials uncovered in archaeological excavations contained the remains of 19th century Cherokee Chief, Oconastota. King examined letters and United States Indian Affairs documents to confirm that grave goods found in the burial were linked to the historic account of the man (King 1979) and concluded that one of the burials, indeed, held the remains of Chief Oconastota.

A similar survey was conducted to verify the burial location of Chief Osceola, renowned leader of the Seminole tribe of Florida during the 18th century. His grave had been heavily vandalized (Dowd 1980). Using forensic anthropology and primary historic documentation, Dowd confirmed the identity of Osceola based upon the comparison of the condition of the remains to the historic sources. The doctor treating Osceola at the time of the chief's death in 1838 recorded that he had removed Osceola's head and preserved it. Forensic evidence

confirmed that the head was removed by an individual that had expert knowledge in surgical practices (Dowd 1980).

These case studies illustrate that the volume of data available in cemetery research provide meaningful anthropological insights because cemeteries are snapshots of the culture of its associated society. Well-maintained cemeteries potentially provide abundant data about its population such as demographics, family relationships, mortality rates, epidemics and conflict, to name a few examples. Conversely, cemeteries that fall into disrepair and are neglected to the point of passing from living memory can be irreparably damaged by development and construction. New techniques and tools emerged to facilitate research in rediscovered cemeteries. Ground Penetrating Radar (GPR) is one such tool that offers enhanced application potential to research, protect and manage cemeteries in any condition.

Historic Cemeteries: Studies Conducted using GPR

During the latter half of the 20th century the use of GPR as a effective survey tool for historic archaeological survey was established (Bevan and Kenyon 1975; Conyers and Goodman 1997; Conyers and Cameron 1998; Kenyon 1977; King et al., 1993). GPR facilitated archaeological prospection and excavation, and also offered a means to preserve and manage historical known sites such as cemeteries. During the early application of GPR, cemeteries offered a venue to test and calibrate both the methods and machinery of this particular form of geophysical survey (Doolittle and Bellantoni 2009; King et al. 1993). Work conducted abroad and in the United States demonstrated that GPR could identify structures such as vaults and

burials with a reliable degree of accuracy (Conyers 2006; Lorenzo et al. 2002). Lorenzo (2006) and Conyers's (2006) work in Spain revealed the GPR could record the voids created by underground vaulting. Doolittle and Bellantoni's (2010) work in Connecticut was conducted over a number years. Their research examined characteristics that were favorable for location of unmarked and unknown graves. They discovered that natural and cultural conditions had an effect on how effective GPR was in locating these types of burials (Doolittle and Bellantoni 2009). They noted the effectiveness of GPR to locate burials was dictated to soil types, burial materials and age of the interments. According to Doolittle and Bellantoni soils have an effect on wave attenuation, the loss of wave energy, as the radar wave travels through the sub-surface. The burial materials, be it the casket or the body, can deteriorate over time which in turn reduces the reflection signal returning to GPR unit. They noted in their final discussion that the effectiveness of GPR was governed by site conditions that included soils, the reflective attributes of the burial and the GPR instrumentation to locate unknown graves (Doolittle and Bellantoni 2009).

This understanding moved research on cemeteries and burials towards experimentation with GPR and refining the process for burial locations. This experimentation was originally directed in forensic anthropology to identify clandestine burials (Fielder et al. 2009; Dupras et al. 2006; Schultz 2003). But research was conducted in other environmental areas where burials might present a problem in using GPR (Gontz et al. 20110). With limited source material on what to expect when using GPR for burial location, experiments were conducted that used pig

carcasses to mimic human remains (Fletcher 2011; Hawkins 2009; Schultz et al. 2006; Schultz and Martin 2011). These particular studies were performed in Florida in soils that are similar to what would be encountered in conducting GPR surveys in this study.

This survey at CCAFS is among the latest in a number of surveys conducted using GPR in Florida. Other surveys executed in Florida used GPR in coordination with other methodologies to provide insight beyond just the location of unknown burials (Chilton 2007). Wardlaw (2009) conducted a survey in Orlando, Florida, at Greenwood Cemetery that used geographical information systems (GIS) that supported the hypothesis that the effective detection of burials by GPR was related to the age of the burial (Wardlaw 2009). He provided evidence that indicated younger burials were recorded more effectively by GPR than older burials. Conyers and Corey (2002) performed a GPR survey in Key West, Florida, to locate a mid-19th century African cemetery as it related to historic documentation. The non-invasive character of GPR was the optimum survey methodology for this cemetery (Conyers and Corey 2002).

Ongoing GPR surveys at Saint Michael's Cemetery in Pensacola, Florida, reveal large geophysical anomalies that indicate mass burials present at this site (Rosenberg Marshall 2013). Rosenberg Marshall (2013) followed the GPR survey with excavation of the larger geophysical targets. While the excavation did not uncover mass graves, it did locate unmarked burials.

The aforementioned surveys were conducted in similar soil and environmental conditions to those at CCAFS. The non-invasive characteristic of GPR to a site provides the means to obtain useful data. In the case of cemeteries where the sentiments of living

descendants would likely be offended by invasive methodology, GPR is an ideal tool for cemetery management and maintenance. Cemeteries that are no longer in use but have a living descendant community, as is the case for the homestead cemeteries at CCAFS, benefit from GPR as a means to gather information to further preserve, protect and curate these cultural resources and historic artifacts for the future.

Principles of GPR

The use of electromagnetic waves to discern sub-surface features began in the early 20th century (Conyers 2013:5). Geologists and the military found that radar waves directed into the ground would pass through dense objects, in this case glaciers. The resulting return echo records the boundary of the ice and the bedrock beneath the glacier (Conyers 2010; Conyers 2006b; Smith 2012). From these beginnings the development of geophysical technologies continued, and eventually encompassed a variety of the survey methods used by a diverse range of professions (Jaselskis et al. 2013; Cezar et al. 2001; Petinelli et al. 2011; Solla et al. 2011). GPR offers, with enhanced software and hardware, a flexible platform in conducting sub-surface surveys. Since the survey discussed in this thesis is located in historic cemeteries, GPR's ability to non-invasively prospect protects the integrity of the site while maximizing information obtained.

The GPR unit consists of three integrated components that are incorporated for use on one platform. The first component is a data collector that has the GPR imaging software used to record data recovered from the survey. The second and third components are the receiver and

the antenna. They are integrated into one device and are attached to a cart which is either pushed or pulled along a predetermined transect (Böniger and Tronicke 2009). The GPR unit emits electromagnetic radiation in the form of radar waves, directed down into the sub-surface strata by the transmission antenna (Conyers 2006b; Conyers 2010a). When the waves are emitted, they radiate out as a downward-pointing elliptical cone with the apex being formed by the antenna (Conyers 2006a; 2010b). A second antenna on the GPR receives the waves back as reflections of sub-surface structures or features (Ernenwein and Kvamme 2008; Leckebusch and Peikert 2001). When all traces are combined together and recorded by the GPR, they produce a reflection profile of the sub-surface. If there are any features that show up as point source reflections in the reflection profile, they are seen as parabolas in the two dimensional slices of the sub-surface (Conyers 2006a).

A point source reflection is the point where the electromagnetic wave encounters a change in the electric conductivity of the surrounding sub-surface material (Conyers 2006a, 2006b). Though the wave continues downward into the sub-surface, a portion of the wave is reflected back to the receiving antenna of the GPR unit that then records the depth of the anomaly (Conyers 2006a, 2006b). This information is then compiled and analyzed with GPR software. The aggregated image of multiple transects, known as a horizontal slice, provides a plan view of a surveyed area and is used to determine if any previously unknown features are present in the GPR survey area.

Conditions on the ground, in the ground, the lack of conductible material distributed in-situ, and the age of the material as well as the GPR unit itself can impact the data recovered in a

positive or negative way (Hansen et al. 2014; Leckebusch 2011; Leckebusch and Peikert 2001; Conyers and Leckebusch 2010). Subsurface soils offer varying degrees of resistance to the electromagnetic pulses sent out by the GPR unit (Conyers 2006; Doolittle and Bellantoni 2009).

GPR use electromagnetic pulses to probe the sub-surfaces soils. Those soils and sediments have an electrical charge that impacts the how the electromagnetic wave travels in the subsurface. Depending on the water and soil composition the electrical charge will impact the strength and speed of the GPR electromagnetic wave. This electrical charge is called the Relative Dielectric Permittivity (RDP) or dielectric constant of geologic materials (Conyers 2013). Understanding the RDP of the material the GPR electromagnetic wave is passing through is important because the RDP is related to how buried material stores and radiates energy back to the GPR unit (Conyers 2013; 2012).

Variables such as material composition will affect the speed of the pulse going to the geophysical target and the return to the GPR receiving antenna, and must be mitigated in post-processing. Other variables that must be considered are the time of year and the time of day the survey is conducted. If there are changes in soil temperature during a survey, the end results can be impacted if not mitigated during the post- analysis phase of the research (Conyers 2006; Doolittle and Bellantoni 2009).

GPR Processing

Following the field survey but before any analysis can be conducted on the GPR data, the raw data must be “cleaned” and prepared for post-processing. There are steps that logic dictates

to preserve the survey data and provide copies to work with during the processing phase of the GPR survey. The first step creates a copy of the data recovered during the survey which becomes the master copy and is archived. No processing work is conducted with this copy. Once a copy is produced the next step is remove test, “bad” or corrupted files. With these files gone the “clean” reflection profiles are ready to be processed. In processing the profiles time zero is established. Time zero is the term used to indicate where the electromagnetic wave first came in contact with the ground surface (Conyers 2013:99). With time zero established the next step filters the “noise” that was recorded by the GPR during the survey. There are a number of sources of “noise” or interference that degrades the reflection profiles of the GPR. The noise can be anything from the operator of the GPR, the antenna of the GPR or outside electromagnetic energy such as cellular towers (Conyers 2013:78-80). To remove this “noise” filters are applied in a specific order during the post-acquisition processing of the reflection profiles (Conyers 2013:129-131). Once the surface has been determined filters that remove horizontal banding that is attributed to GPR unit and surrounding background frequency interference (Conyers 2013:130). The next step of the filtering process removes the high frequency noise that appears as “snow” in the reflection profile (Conyers 2012:96; Conyers 2013:131). Once the background filtering processes are completed the reflection profile may need to be gained to increase their visibility (Conyers 2012:41-42). The filtering processes used in post-acquisition processing are bundled in third party GPR processing software that are used in archaeology today.

GPR Research at Cape Canaveral

If GPR is used in a collaborative methodological framework, the end product will reflect that situation. In establishing a “use” history for the cemeteries on Cape Canaveral, we need to anticipate any limitations and anomalous findings in the survey. The optimal scenario using GPR is achieving a clear image of the sub-surface. Unfortunately the validity of what the GPR is representing in the data can only be tested by actual excavation (Conyers and Cameron 1998). This is acceptable when dealing with house foundations, anomalous sub-surface features, or unassociated burials, but fails to offer a solution when investigating known features that cannot be excavated, such as historic cemeteries. The failure is caused by the simple fact there is no way to verify what the GPR recorded. It is contended here that in its present format, GPR is only as good as the supporting information that is gleaned from other sources of data. As will be discussed later, the age of the cemeteries, location of the cemeteries and settlement patterns of Cape Canaveral have a direct influence on what the GPR survey records. The use of supporting documents provides verification of the homesteading activities on the Cape.

Another important activity that must be mitigated for in researching the historical use of the CCAFS cemeteries was the military construction on the Cape. In general, construction activities have a dramatic effect on surface and sub-surface stratigraphy. Depending on the area and depth of the construction, the stratigraphy becomes unreliable for comparative analysis (Cantley et al. 1994; Huckle et al. 1971; Schmaizer and Hinkle 1990). This means the original stratigraphy of the pristine Cape Canaveral has been heavily modified by construction.

Depending on the depth of construction, the original stratigraphy has been altered and cannot be taken for granted as natural throughout the Cape (Cantley et al. 1994). Building and road construction that alters the landscape is just one activity that disturbs the natural stratigraphy of the Cape. This type of construction alters the topography of the surface landscape but the impact is limited in the sub-surface.

Another type of activity that leaves traces for GPR to detail are those that cut into the strata and then mixes that material in specific locations (Conyers 2006a, 2006b). Unlike activities that alter a landform over a broad area, this mixing leaves a defined and distinct footprint. In the case of burial activities, the footprint is small and the edges can form a distinctive and discreet boundary for the GPR to record the mixing of the strata (Conyers 2006a). The cultural and societal concepts on the sacred nature of a burial can protect the footprint and cut boundary in the sub-surface from the diffusion that occurs with larger and utilitarian construction projects. In particular, the cemeteries on Cape Canaveral offer the chance to confirm this assertion regarding the burial footprint when viewed through the lens of GPR.

Geography of Cape Canaveral

Cape Canaveral is located on the east coast of Brevard County in Central Florida. A brief history of settlement on the Cape previous to its use for military installations will be presented in Chapter 3. During the 20th century, two main entities shaped and extensively modified the peninsula: CCAFS located on the south end, and Kennedy Space Center (KSC) located to the north. CCAFS has been used as a military installation since the early 1940s, but has actually

been associated with the military in some form since the 1840s (Cantley et al. 1994; Levy et al. 1984). Recent aerial photographs reveal extensive coastal modifications such as landing strips, command control buildings, military housing, and supporting infrastructure such as roads and drainage canals for the operation of CCAFS and the launch facility of KSC (Figure 1). The interior of the cape houses a large number of structures in the form of buildings, primary and secondary roadways as well as rocket launch platforms.

Only one cemetery, Cape Road Cemetery, is identified on the Brevard County Registry of Cemeteries. It can also be located on the Google Earth map application. Documentation from the Department of the Air Force indicates five additional cemeteries: Quarterman South Cemetery, Quarterman North Cemetery, Wilson Plot, Penny Plot and Osmon plot. When viewed using Google Earth, the flora canopy concealed their locations. This implied that these cemeteries were not good candidates for the use of GPR, but a phase one pedestrian survey confirmed that they were fenced and maintained.

Environmental Conditions at Cape Canaveral

Since this project is multi-methodological in composition, it is important understand present environmental conditions at CCAFS. Sub-surface conditions at the Cape were mapped using ArcGIS (Figure 2). To accomplish this, various resources were used to lay the geological ground work for this project. Data was obtained from governmental sources such as the County Development Board of Brevard County as well as information from the State of Florida and Federal Departments of Defense and

Agriculture maps were utilized and cited in addition to the US Geologic Survey and private map provider Google Earth.

Cape Canaveral: Sedimentology

The entire cape is considered shoreline but falls exclusively into the Silver Bluff terrace structure topographically, which extends past Jacksonville in the north down through the survey area of Cape Canaveral around the southern tip of Florida then back up the coast to Fort Meyers on the west coast of Florida (Figure 3) (Healy 1975). The sedimentological aspects of the cape are similar to a barrier island even though it is connected to the Florida mainland. The sandy soil forms dunes on the front zone facing the Atlantic, with more compaction and stratification moving west through the other two zones to the Banana River.

The soil is made up of fine to medium-grained quartz material that is of undifferentiated deposits of shell, clay, marl, or peat that rest on Miocene and Pliocene deposits of unconsolidated beds of sand (Schmalzer and Hinkle 1990). The stratigraphic soil column is as follows: surface down to 15 foot below surface level is fine sand, from 15 to 30 feet below surface are fine to medium grain sands, from the 30 to 130 foot mark below surface are fine grained sand, marl, grey green clay, silt and shell (Schmalzer and Hinkle 1990). This formation is consistent along the coast of Florida. Conditions may be altered if there has been any landscape modification due to human or bioturbation agencies.

The core area of the peninsula is a uniform soil consistency despite the extensive building program of the latter part of the twentieth century. Unlike the rest of the Cape, the

western section has a high concentration of clays which can have an impact on the GPR survey. This is also where the bulk of the cemeteries are located. The contours of the land are consistent with the topography of coastal settings along southeastern Florida.

It must be noted that at the cemeteries, the soils were relatively undifferentiated and maintain the historic stratification of the sub-surface at least from the 1850s. Homesteader activities and later military construction had limited impact on these areas. This is based on two considerations. First, once a cemetery is established and maintained, the area within that space becomes sacred and is reserved only for burial activities. Secondly, land designated as a cemetery remains separate from all other activities related to running a homestead. Burnham Cemetery had a stratigraphy that was complex because the homesteaders established their burial ground atop an earlier Native American midden. This cemetery actually had better preserved stratigraphy than any of the rest of the CCAFS's cemeteries.

Hydrology of Cape Canaveral

Cape Canaveral has a diverse hydrology. To the west of the peninsula is the Banana River that is a part of the Indian River Lagoon system. These waters are brackish in nature supporting a tidal salt flat eco-system. To the east is the Atlantic Ocean. These two features impact the sub-surface water table and the resulting salinity levels of the corresponding soil strata which ultimately impact GPR. Five cemeteries are situated a short distance from the Banana River. Seasonal water levels of the river will invariably affect the geological conditions

at these cemeteries. Another of the cemeteries, Cape Road Cemetery, is located between the river and the Atlantic Ocean (Figure 4).

There were no standing bodies of water present and groundwater intrusions were not evident for real-time pedestrian survey. However, hydrological resource tables from the USGS indicate that a 3 m layer of recharged fresh water flows east to the Atlantic Ocean and west to the Banana River (USGS 2015). This discharge zone rests on a layer of intruding salt water that may have an impact if the GPR survey is done during the annual winter/spring drought (Schmalzer and Hinkle 1990). Salt water has a scattering effect on GPR electromagnetic wave. Salt water has a RDP of 81 to 88. The higher the RPD of a material means the energy will travel slower through that material and will dissipate (Conyers 2013:53). Drought conditions during the winter months in Florida allow salt water to intrude into the fresh water discharge zone affecting GPR performance.

Flora of Cape Canaveral

The flora of the peninsula resides in three zones along its length but is still considered coastal. The Atlantic side or the frontal zone of the peninsula has quite extensive beds of sea oats (*Uniola paniculata*) and other grasses (Williams 2007). In the center of the peninsula as well as along and around the installations and roadways is the second area that is referred to as "back dune zone" and contains sea grape (*Coccoloba univera*), wax myrtle (*Morella cerifera*) and saw palmetto (*Seronoa unifera*) throughout the area (Williams 2007). The final zone, the maritime and hammock stands, have a variety of flora types such as pine (*Pinus clausa* and

elliottii) and sand live oaks (*Quercus germinata*) that dominate the western edge of the peninsula bordering the Banana River (Williams 2007; Atlas of Florida Vascular Plants 2014). The types of indigenous plants on the Cape develop root mats that add geophysical noise to potentially obscure buried anomalous targets.

Climate of Cape Canaveral

Dynamic weather patterns impact the climate of the Cape. From the winter dry season to the summer hurricane seasons, patterns normal for the Cape affect the levels and salinity of the subsoils (Kelble et al. 2007). The Cape is located in a subtropical zone with high summer humidity and low winter humidity with an average precipitation amount of 52 inches a year (Florida Climate Center 2015). Cape Canaveral has temperatures average from 62.8°F as a low to 81.9°F as the high with an average yearly temperature of 72.4 °F (Florida Climate Center 2015). The amounts, frequency and severity of the yearly weather cycles are not uniform but do follow the above described patterns with certainty (Lazarus 2009; Schmidt et al. 2001; Smith et al. 2007). The Cape is also impacted by regional and world climatology that has an effect on its hydrology (Lazarus 2009; Ren et al. 2012; Smith et al 2007).

As has been shown cemeteries offer ties that bind a community to its past. But communities grow, change and develop in ways that do not take into consideration all that a cemetery represents. If the cemeteries are physically maintained and preserved, it has been shown that meaningful knowledge can be gathered for society. GPR, offers a “here and now” way to manage and document the cemetery. It is important to be aware of the weather patterns

and season precipitation rates as they affect how well GPR records data. Also the documentation of biological intrusions in the areas to be surveyed plays a role in analyzing the GPR data. GPR provides a valuable tool coupled with a thorough understanding of the geophysical sub-surface and environmental variables of the cemeteries to manage and preserve in an effective way sites located at CCAFS. To that end let us turn next to the methodology used to conduct the survey on the cemeteries on CCAFS.

CHAPTER 3: METHODOLOGY

Introduction

The methodological approach to conducting the GPR survey will be discussed in this chapter including site selection, equipment used, dates and times the surveys took place, basic field methods, and general challenges that arose. A brief summary of the settlement of the Cape prefaces corroborating ethnographic research of the individuals buried in the CCAFS cemeteries. The ethnographic data will provide specific demographic evidence regarding vital statistics and family relationships. The infusion of ethnographic information on the Cape homesteaders with the GPR data ensured historical accuracy that enhanced the post-processing analysis of the geophysical information derived from the GPR survey.

History of Cape Canaveral

Early Settlement

Cape Canaveral has a long history of occupation from the pre-Columbian period right through to the present day (Childers 2005; Scarry and McEwan 1995). Pre-Columbian peoples have occupied the region for many thousands of years (Childers 2005). Evidence of this occupation exists on Cape Canaveral in the form of Pre-Columbian shell middens, which are documented along the western edge of the peninsula along the Banana River. The decline of native populations followed the discovery of Florida by Spain in the early 16th century and its subsequent colonization by European powers (Childers 2005). The area was extensively mapped

by the Spanish between the sixteenth and eighteenth centuries (Childers 2004; Ruhl 1997). During the middle of the 16th century, the Spanish attempted colonization of Cape Canaveral. That brief effort lasted from December 1565 until the colony was abandoned in March of 1566 (Childers 2004). Spain ceased expansive colonization of Florida to focus on her holdings in northern Florida based at Saint Augustine on the east coast and Pensacola on the western Gulf coast of Florida. This area became known as Mission Florida and was the core area that would become the present state of Florida (Childers 2005; Ruhl 1997).

Following the American annexation of Florida during the early part of the 19th century, Cape Canaveral was developed militarily as a light house station. During the late 1830s, the United States Government authorized the construction of a lighthouse on the eastern margin of the Cape to assist in navigation and protect ships from underwater obstacles. Construction of the original light house was completed by 1847, and it became operational in 1849 (United States Army Corps of Engineers, Cultural Resources Investigation of Site 8BR239 [Cape Fish Company] 2008). In 1853, Mills O. Burnham, one of the original homesteaders of the Cape was appointed the first lighthouse keeper (Figure 5) (Wooley 1998). Burnham retained the job as lighthouse keeper for 35 years until 1886 (Wooley 1998). His tenure in that post included the American Civil War and the post-postbellum Florida land boom of the late 1860s and early 1870s.

The settlement of the Cape was in a large part attributed to the lighthouse (Baxter et al. 2006; Cantley et al.). With that construction and the end of the Second Seminole War, permanent occupation of the Cape was a reality (Porter 1943; Knight 2010). Beginning with Mills O.

Burnham and followed by other homesteaders, the Cape was partitioned to create homes and farms.

Cape Canaveral Homesteaders

Settlement occurred gradually on Cape Canaveral beginning in the 1850s and continuing to the late 1880s. A survey prepared between 1859 and 1860 supported by Florida tax records from the late 19th century confirm that by 1885 at least nine families including the Burnham, Wilson and Quarterman, occupied homesteads there (United States 1880 Population Census). While further sub-division of the land occurred due to sales, marriages, inheritances, and the arrival of new settlers, there is only a small group of surnames that have bearing on this survey. The cemeteries left on the respective homesteads of these families provide the platform for the research and analysis of this survey.

The Cape retained the frontier character of the homesteads throughout the late 19th and early 20th centuries (Carlson 2010; Otto 1986). The arrival of the railroad in the 1880s increased communication and transportation between the Cape and the world, but the homesteads were still a quiet backwater compared to the rest of Florida (Carlson 2010). The one institution that was a permanent fixture on the Cape was the lighthouse. The original lighthouse was replaced after the Civil War with a more modern structure (Baxter 2006). Due to shoreline erosion, the new lighthouse was moved to its present location on the Cape in 1894 and the original lighthouse was demolished to provide base material for the new one (USACE 2008).

Cape Canaveral Development in the 20th Century

In 1950, the government purchased all privately owned land on Cape Canaveral and the remaining descendants of the Burnham, Wilson, and Quarterman families and the families that worked at the fish processing plant and citrus cultivation relocated to other areas of the country (USACE 2008). The United States Air Force assumed control of the lighthouse and the cemeteries but demolished the majority of the buildings on the Cape to make way for development of its launch facilities.

For decades, the economic activities of the Cape were centered on exploitation of land and sea resources. This was reflected in the type and dispersion of the structural remains. In a cultural resource survey conducted in 1984, the researchers indicated that foundations and walls of the homesteads, out-buildings and commercial structures were either in a high state of decay or had been “pushed” into piles by the Air Force to make way for ongoing construction (Levy et al. 1984).

The Cape today has few reminders of its occupational past beside the cemeteries. At the time of this survey there were no free standing structures from the homesteader occupation visible near the cemeteries. The cemeteries offer a window into the past and that must be preserved. The protection of these cultural artifacts and the documentation of their place in time provided the impetus for the survey of the cemeteries.

Historic Cemeteries on Cape Canaveral

Seven known historic cemeteries are located at CCAFS. These cemeteries are vestiges of the Cape's homesteader past. A comprehensive archival search was conducted in 2014 for this thesis that compiled local histories and personal ethnographies of the American homesteaders of Cape Canaveral. This search utilized peer-reviewed publications, state and federal documents and accredited public historical resources (Deagan 1988; Underberg 2006) supplemented with data obtained from internet third-party sites such as Ancestry.com, Fold3.com and Graveregistry.com to create genealogical kinship diagrams identifying descent and marriage relationships among the people buried in the named graves. Legacy 8 Family Tree Genealogical software, produced by Millennium Corporation, was used to organize and document the myriad of multimedia and hard data relating to the demographics of the cemeteries in the survey (Figure 6). The use of commercial software, when it offers the flexibility and interactive platforms that meet the needs of academic research, was considered acceptable and desired (Burton 2003).

CCAFS manages all of the facilities and cemeteries on their portion of Cape Canaveral. The seven cemeteries scattered among these facilities ranging from community/family-sized plots to isolated graves. All the cemeteries are located on coastal margins. Geographically there are six cemeteries situated on the west side of the peninsula along the Banana River and one cemetery located on the east side of the peninsula. The cemeteries are: 1) Cape Road Cemetery, a community/family cemetery; 2 and 3) Quarterman Homestead Cemeteries, South and North;

4) Burnham Homestead Cemetery; 5) Wilson Cemetery; 6) Penny Plot, with one named grave; and 7), on the eastern side of the Cape bordering the Atlantic Ocean, a single grave containing Harry Osman, a sailor who drowned in 1913 (Wooley 1998). The first four cemeteries were chosen for the survey. The three remaining cemeteries, Wilson, Penny and the Osman plot were not surveyed due to floral intrusion. All the cemeteries in this study contain individual family burial sites except for Cape Road cemetery which includes members from the Artesia community (APPENDIX N).

Cape Road Cemetery was established from a grant of land purchased by Samuel Jeffords in 1894 to bury his son (Wentworth 2000). “Artesia” was the original name for this cemetery but it was also known as the “Jeffords Family’s Cemetery” (Wentworth 2000). With the incorporation of Artesia, this cemetery became a community burial site. According to the headstones and markers, the first burial was Jeffords’s son in 1894, and the final burial was Charles A. Terryn who was interred in January 1949. There are at least two generations of families buried at Cape Road Cemetery.

The remaining cemeteries are exclusively family and descendant burial plots. Quarterman South Cemetery contains the remains of George and Mary A. Quarterman (APPENDIX N). There is also a smaller headstone in memory of V. W. Quarterman who likely died as an infant. Of note is the condition of George Quarterman’s headstone; it is a recent addition to the burial plot. According to Wentworth (2000) there was no headstone besides Quarterman's wife’s to indicate that he was buried beside her. Through conversations with

descendants and literary research, Wentworth concluded that George Quarterman was indeed buried beside his wife.

Quarterman North Cemetery includes the plots of George M. Quarterman and Anna D. Quarterman. George M. Quarterman was the son of George and Mary Quarterman. Anna D. (Burnham) Quarterman was the youngest daughter of Mills O. and Mary A. Burnham. Their burial markers are modern. Also located in Quarterman North Cemetery is an area with one single wooden marker bordered by individual concrete posts estimated to be 0.5 m above the ground surface. According to a 1993 cultural resource survey conducted on site, this plot is related to the family pets as reported in an interview with Mrs. Oscar Floyd Quarterman in 1971 (Cantley 1994).

Burnham Cemetery contains multiple generations of Mills O. and Mary A. Burnham's immediate family and at least one additional family member (APPENDIX N). The burials of Mills and Mary are in the western center of the cemetery. The remains of Henrietta Wilson, granddaughter of Mills and Mary Burnham, lie in a concrete enclosure to the north of their plots. Henrietta's second husband, Thomas Thompson, is interred beside her. Henrietta was the daughter of Henry Wilson and Frances A. (Burnham) Wilson. Frances was the eldest daughter of Mills and Mary Burnham, and her grave is located to the south of her father's grave. The two remaining graves belong to Elliot J. Burns and an infant, Harold W. Butler. Harold was born on 8 June 1914 and died on 13 August 1914. At that time, the assistant lighthouse keeper was a John B. Butler (Baxter et al. 2006). There is the possibility that these two individuals are

connected as father and son; Elliot J. Burns purchased the home of Mills and Mary Burnham (Langlais 1984).

An element of the story of the Burnham family cemetery is related to two sons of Mills O. Burnham who preceded him in death: George and Mills O. Jr. George was born in New York between 1836 and 1838 and traveled with the family as they moved south to Florida in the early 1840s (Figure 7) (Baxter et al. 2006; NPS 1984; Ranson 1926; Stacy Pomeroy Draper email communication 2014). George's life and subsequent death was described by Ranson (1926) in his memorial narrative on the life and times of Mills O. Burnham. Later historical research and cultural resource management reports used Ranson's work to confirm that George Burnham died in August 1849 during the Second Seminole War on a voyage from the Indian River region to St. Augustine. Though not stated in Ranson's work, it is assumed that he was buried at sea.

The death of Burnham's second son has somewhat better provenance. At the start of the American Civil War, Mills O. Burnham, Jr. volunteered for service in a Confederate regiment raised for the defense of Florida. He was mustered in April of 1862 and was stationed at Cape Lee, Florida. He was attached to the 7th Florida Infantry his regiment which eventually travelled north to Chattanooga, Tennessee. According to historic records, Mills died on July 10th of 1862, but there is a discrepancy regarding the location of his grave (Figures 8, 9 and 10). Although documentation implies that Mills was buried in Atlanta, Ranson mentions traveling to Chattanooga, Tennessee, in 1901 where he saw a memorial marker with Burnham's name (Figure 11) (Ranson 1926). Regardless, there is enough documentation regarding the burial of

Mills O. Burnham, Jr. to satisfy that he is not buried in the family cemetery but is buried in Chattanooga.

The burials at the historic cemeteries on CCAFS follow traditional Christian funeral practices where spouses are buried together. According to tradition, the burial spatial relationship should be the wife located on the right of the husband (Rugg 2013). The graves of Henry and Frances Wilson at Burnham Family Cemetery and George and Anna Quarterman at Quarterman North Cemetery reflect this practice. However, the burials of Mills and Mary Burnham, Thomas and Henrietta Thompson at Burnham Family Cemetery and George and Mary A. Quarterman at Quarterman South Cemetery reversed the spatial relationship, with the husband interred on the right side of the wife. At Cape Road Cemetery, the traditional spatial arrangement of the wife on the right-hand side of the husband is also the preferred burial practice. For example, the graves of Vida Kate and Charles William Jandreau, Allee and Willoughby Whidden and Julia and Samuel Jeffords conform to this.

There is evidence of enslaved Africans present on the homesteads thought out Volusia County. Though Brevard County would encompass Cape Canaveral in the future it was part of Volusia County in 1860. In the 1860 United States Census the demographic designations for “White”, “Freed Colored” and “Slave” in Volusia County showed an aggregate population of 1,158 individuals. Of that population 861 were white, while the remaining 297 were slaves of color (Kennedy 1864). The names of the two principal families on Cape Canaveral, Burnham and Wilson do not appear as slave owners in either the original returns of the 1860 United States

census nor in a report on population of the United States, written by Joseph C. G. Kennedy at the direction of the United States Secretary of the Interior in 1864. There was however indirect confirmation for enslaved Africans at the Cape (Ranson 1926). The one piece of direct evidence is a bill of sale with Mills O. Burnham's signature for the purchase of a "servant," but there is no clear indication that enslaved African burials took place in any of the homestead's cemeteries (Figure 12).

Ground Penetrating Radar Methodology

Site Selection

The choice of Cape Canaveral Air Force Station for this research was based on the history and location of the cemeteries. GPR works best in areas of minimal biological and landscape modification. In areas of urban development it is also beneficial to understand the effect that urban growth has on or around the site. The site needs archival documentation to confirm the history of the site past to present. Where GPR explores the sub-surface features of a site it is the surrounding environments, artifacts and documentation that offer explanations to what the survey finds.

Of the seven cemeteries at CCAFS, four were good candidates for GPR surveys: Cape Road Cemetery, Quarterman South Cemetery, Quarterman North Cemetery and Burnham Family Cemetery. A number of considerations were used to select these four. The uniform nature of the sandy sub-surface soils with lower clay content provides for excellent electromagnetic propagation and reception for the GPR antenna (Conyers 2013). As noted previously, the time of

year and lack of intense precipitation meant the water table would not inhibit the function of the GPR (Weaver 2006). The maintenance of the cemeteries was also a factor in selecting them for the survey. CCAFS had maintained the grave markers and provided documentation of the historical use of the cemeteries. The documentation also included information for graves rumored to be present in the cemeteries but unidentified by physical markers.

Cape Road Cemetery (Figure 4) in particular, was well suited for the GPR survey because of the low density of floral intrusion and higher density of marked graves. The assumption that Cape Road Cemetery was a good candidate for survey was also based upon the levels of the ground water, protected status and the soil composition at this site (Weaver 2006). As outlined in the previous chapter, the survey at CCAFS cemeteries was an extension of traditional cemetery research and more recently, GPR use in cemeteries.

Survey Equipment

The components of a GPR unit are the wheeled cart with handle, battery, antenna and control unit. The wheels on the cart are used to measure the distance traveled along transects. This information is then transmitted via direct cable connection to the control unit. The GPR has two optional antenna configuration systems. The first type is the bistatic antenna consisting of two antennas, one that sends electromagnetic pulse and a second antenna that receives the reflected electromagnetic pulse. The second type, the monostatic antenna, is combined as one antenna doing the double duty of sending and receiving the electromagnetic waves (Conyers 2013). The control unit used for the CCAFS survey was a third-party laptop computer and the

antenna system was monostatic. The GPR unit used at CCAFS was a wheel cart manufactured by MALÅ (MALÅ 2011).

To get a general sense of sediment relative dielectric permittivity (RDP) the GPR to the sites surveys at CCAFS, a metal pipe was selected on the north side of Cape Road Cemetery. Using a total station it was determined the depth of the pipe to the modern grid surface. The machine settings were Time Window at 84.1494 with a sampling frequency of 1877.61. The number of samples was set at 158. This is much less than recommended by Lawrence Conyers. He recommends a sample of 512 for archaeological GPR surveys (Conyers 2013:94-95). The samples in the survey conducted at CCAFS were set lower because of the GPR recording unit software. Manually setting the sample higher caused clipping of the sine wave. Clipping occurs when gain is misapplied (Conyers 2013:100-101). At the time it was felt that maintaining the factory specification for gain afforded the best option for data collection. There was no excavation to determine depth because the survey site was location on a military installation and was also a historic cemetery.

The grid was initially set at .5 m transect intervals but at the recommendation of the post-processing software company, the interval was reduced to allow for complete coverage of the survey area using a 250 MHz bandwidth antenna. Higher bandwidth has a reduced wave penetration depth. However, it provides higher resolution imagery of subsurface features and allows for smaller features to be identified. Conditions at the time of the survey determine

which modulating frequency should be used (Conyers 2006a; Doolittle and Bellantoni 2010; Schmaizer and Hinkle 1990).

Chronology of Survey

The initial survey was conducted from August 2011 to October 2011. A re-survey of Cape Road Cemetery Grid 2 using 25 cm transect intervals was conducted during January 2013. This survey was done to compare the geophysical differences in using a 25 cm transect instead of 50 cm. After the comparison, no geophysical differences were noted between the differing transect interval. In Florida, early autumn is the height of the Atlantic hurricane season. At the time of the first survey and through January 2013, hurricanes had no impact on the region. Late summer evening precipitation patterns were observed during the initial survey. Light precipitation occurred once during the survey of Quarterman South Cemetery. The re-survey of Cape Road Cemetery Grid 2 occurred during the winter dry season of Florida and no precipitation was present. Therefore, the impact of weather patterns and local precipitation on the selected cemeteries was negligible.

Field Methods

The GPR surveys for CCAFS were conducted identically on each selected cemetery, using standard practice, along a grid transect laid out perpendicular to the graves within the cemeteries. This configuration of transects was best to completely document the sub-surface area

of the burial for geophysical anomalies. The survey used a boustrophedon technique to record transects in the cemeteries.

In the case of Christian burials, an east- west alignment of the remains is the norm. This is the case at Cape Canaveral (Rugg 2013). Since Christian burials in general are longer than they are wide, more transect area can be covered moving north to south on the survey area rather than east to west (Rugg 2013). The information of burial alignment was important to ensure both largest profile of burials would be surveyed and that the GPR unit covered the most area.

The grid form initially was set at 0.5 m intervals between transects. This allowed for complete coverage using a 500 MHz bandwidth antenna with an option, depending on soil conditions, to utilize a 250 MHz bandwidth antenna. Upon recommendations from the software manufacturer, it was decided to decrease the transect interval to 0.25 m with all other aspects of the survey remaining the same.

Survey Challenges

During the survey a number of real world issues arose that impacted the pedestrian survey. In the initial stage of the Cape Road Cemetery survey, the laptop used to record the raw slice traces malfunctioned. The first malfunction occurred with the software program that digitizes and records raw GPR traces. The software program was closed and restarted, and the cemetery was resurveyed.

Due to the time of year of the initial survey, late summer, heat was a factor. The first two survey areas were completely exposed and devoid of shaded areas to moderate the laptop

heating. The fix for this problem was to shut off the laptop and move it to a place of shade. This cooled the laptop enough to continue the survey from the last successfully recorded transect. The remainder of the survey was conducted in areas of thick forest canopies. This mitigated the natural radiant heat buildup of the laptop. This in turn lowered the need to close out the laptop due to overheating.

The final challenge throughout the survey was the pervasive issue of battery power loss to the control unit of the MAIA GPR. This was mitigated by the availability of a standby replacement battery which replaced the drained unit. The survey was then continued from the point of the last successfully recorded transect.

The cemeteries at CCAFS provided a viable platform to expand cemetery research with the practical use of GPR. The location of unknown burials at these sites provided the opportunity for guidance in protection, preservation and maintenance of the cemeteries. The selection of survey sites over others because of natural and geophysical limitations was deemed an effective use of limited time and material of the survey. There were mechanical and computer malfunctions that arose during the survey that were mitigated for during the processing and post-processing analysis of the GPR trace data. The mitigation of the GPR data and the processing and analysis of said data is the subject for discussion in Chapter 5.

CHAPTER 4: PHYSICAL DESCRIPTION OF THE CEMETERIES

The majority of the cemeteries on Cape Canaveral Air Force Station (CCAFS) are located on the western side of the peninsula. There is one outlying single plot cemetery on the east side of the peninsula located close to the Atlantic Ocean and above the high water tide mark. The locations of the western cemeteries are directly correlated to the settlement and development of Cape Canaveral during the 19th century. The grounds of the homesteads were high and dry enough to support the subsistence activities of a pioneer family. The evidence on site points to the area as being a favorable site for prehistoric habitation as well (Childers 2005; Scarry and McEwan 1995). The National Park Service maintains fenced areas designated as prehistoric sites. One of the cemeteries surveyed, Burnham Cemetery, is situated on a pre-Columbian shell midden. Just as the original inhabitants recognized the advantages of habitation on the western side of Cape Canaveral, the early American pioneers that settled the region did as well.

Cape Road Cemetery

Cape Road Cemetery is located in the median of a four lane main road leading into and thru CCAFS. The road is named “Samuel C. Phillips Parkway” and runs north and south. Samuel C. Phillips Parkway originated as a two track wagon road that ran the length of the peninsula and was used by homesteaders to travel to neighbors, to port facilities or the lighthouse (Figure 13). The original two-track road was later surfaced and eventually enlarged to accommodate heavier transportation and ultimately modern vehicular traffic. With the acquisition of the land on the peninsula by the Air Force, this road underwent its final upgrade to

its present form. It was this construction that isolated the cemetery in the median and caused the most surface and sub-surface disturbance that affected the survey conducted with GPR.

Physical Characteristics

Cape Road Cemetery is contained within a fenced area that is 32 m extending north to south by 40 m extending east to west. Though these measurements define the current shape of the cemetery, they are considered arbitrary. To the east of the fence line is a road drainage ditch located at a distance of 1 to 2 m away. On the northern side of the cemetery is a paved access road that links the north and south bound lanes of Samuel C. Phillips Parkway. This access road is about 20 m distant from the northern fence line of the cemetery. The area between the road edge and the fence line is such that the survey was not conducted there due to the location of the access road. To the west of the cemetery are the south-bound lanes of the Samuel C. Phillips Parkway. Between the eastern edge of the parkway and the western fence line are a number of trees that render this area unsatisfactory for a GPR survey based on the intrusion of the root mats and root structure of the trees. Also of note is a 1-m-high identification and historical marker constructed of red brick that lists the name, benefactor and dedication date of the cemetery. To the south of the cemetery is the open area of the median. This area is devoid of trees and obvious obstructions and was designated Cape Road Cemetery Grid 2 during the survey (Figure 14).

The interior area of the cemetery contains a number of important features. There are stands of trees located throughout the cemetery that potentially affect the performance of the

GPR (Figure 15). There is a group located on the western edge of the fence line of the cemetery. Though the trunks and canopies of these trees are outside the cemetery fence, their roots and root mats impact the survey. These trees are Sand Live Oaks (*Quercus germinate*) and Sabal Palmetto (*Sabal palmetto*) (Williams 2007). The second group of trees is located in the northwest central area of the cemetery and also consists of Sand Live Oaks and Sabal Palmetto. The third group of trees is a loose concentration of Sabal Palmettos located adjacent to the south central fence line. The root systems of the Sabal Palmetto, as individual trees, affect GPR less than the individual Sand Live Oak trees but in the concentrations present at Cape Road Cemetery, their root “footprint” must be taken into account. The fourth group of trees is an elongated cluster of Sand Live Oaks and Sabal Palmetto that extend from the central southeast fence line to the southeast corner of the southern and eastern fence lines.

The burial plots themselves are another prominent feature. There are a total of 20 markers with various identifications including given, middle and surnames. In addition to the identifiable burials, there are also markers that denote burials of unnamed individuals. The identified burials are dispersed throughout the cemetery with a majority of them occurring along the eastern edge of the cemetery. There are also groupings of identified burials located in the central, south central and northwestern areas of the cemetery.

Cape Road Cemetery Grid 2

To the south of the Cape Road Cemetery, and also situated in the roadway median, is an area that runs along the southern fence line of cemetery. This area is of interest because of its

proximity to Cape Road Cemetery. The designation for this site is Cape Road Cemetery Grid 2 (Figure 16). The physical dimensions of the grid are 20 m extending north to south and 39.5 m extending east to west. The grid dimensions are arbitrary, but because of its location on the southern fence line of Cape Road Cemetery, it serves a dual role of advancing the survey by locating potential sub-surface anomalies and offering a standard by which to judge the effectiveness of the GPR for the rest of the survey. Because the area was not used as a cemetery the grid can be used as an example of native geology of the Cape. Though this area is level and has been manipulated in the past, it was decided that it was a good candidate for a separate survey. Aerial photographs of the area from the 1940s indicate that land clearing and improvements pre-dated the photographs. Therefore, the possibility of the area containing sub-surface anomalous features warranted an independent investigation and analysis.

Photographs taken during the 1940s show that the area was clear cut and modified. These conditions have been maintained to the present day. There are neither individual trees nor large groupings of trees in the survey grid area. The area has been physically and extensively altered in the past, both by activity of the original homesteaders and later by the Air Force. There is, at this time, no evidence of faunal bio-turbation. Cape Road Cemetery Grid 2 does not have any obvious and typical surface indications that burials are contained within the survey area (Figure 14).

Quarterman Homestead Cemeteries

There are two cemeteries tentatively linked to the Quarterman Family homestead: Quarterman South Cemetery and Quarterman North Cemetery. They are separate from each other and are located north of Cape Road Cemetery. Both are accessed from the south bound roadway of the Samuel C. Phillips Parkway via a two-track sand access road. These cemeteries are situated between the roadway to the east and the Banana River to the west. Historical documents indicate that the Quarterman cemeteries are located on the original homestead of the Quarterman family. For the purpose of this research, Quarterman South is divided into three grids: Quarterman South, Quarterman South Grid 2, and Quarterman South Grid 3 (Figure 17) (Figure 18).

Quarterman South Cemetery

Quarterman South Cemetery is approached from a two-track sand access road bearing west off Samuel C. Phillips Parkway. Extensive stands of Sand Live Oak trees and Sabal Palmettos surround the cemetery. The access road turns north paralleling the Banana River. It is at this juncture that Quarterman South cemetery is located on the west side of the access road. The cemetery is enclosed by a chain-link fence with a simple 36 inch wing gate on the north side boundary fence line. Physical dimensions of the cemetery are 15.2 m by 15.2 m (Figure 19). Along the western and southern boundary of the cemetery, the tree line is thick and tangled but does not intrude into the cemetery, at least not above ground. There are marked burials present (Figure 20). Along the eastern fence line, the access road comes close to the cemetery but does

not impact the enclosed fenced area. The northern fence-line and adjacent area has nominal flora intrusion in the form of isolated Sabal Palmettos clustered in the western area near the northwest fence post.

The floral intrusion within the confines of the cemetery is isolated but impactful. Along the interior fence line are isolated Sabal Palmettos. In the southwest central area of the cemetery is a very large water oak tree. The tree's canopy footprint and related root mat covers the southwest corner of the cemetery. The remaining area is grass-covered, interspersed with bare sand patches and has the appearance of being maintained. The cemetery has three markers and 2 foot stones to indicate the presence of burials. The tree line to the west and south of the cemetery, mentioned previously, has a canopy footprint that is also an indicator of root growth activity. This activity potentially affects sub-surface anomalies and the burial record.

Quarterman South Grid 2

Along the eastern fence-line and bisected by a two-track sand access road is Quarterman South Grid 2. This grid was placed at the eastern edge of Quarterman South Cemetery. It was selected for the survey based upon its proximity to Quarterman South Cemetery and the potential to contain unknown burials. Physical dimensions of the survey grid area are 10 m east and west by 15.2 m north and south (Figure 21). There is floral intrusion in the form of tree root mats in the southwestern corner of the grid. Along the eastern edge and the northeastern corner, the proximity of the access road to these boundaries offer man-made intrusions that must be

accounted for in conducting the survey and interpreting the data. The remainder of the grid is grass-covered with no observable cultural or biological impediments to conducting the survey.

Quarterman South Grid 3

The final grid of Quarterman South Cemetery lies along the northern fence-line of the cemetery. Quarterman South Grid 3 extends 8 m north to south by 15.2 m east to west (Figure 22). This grid comprises the accessible area that offers the best survey options. The grid has minimum floral intrusion. The western boundary shares the tree line described previously in the Quarterman South Cemetery survey area. The area is grassy with areas of bare sand and is maintained by the CCAFS. There are no observable cultural or biological activities in the grid area that impact conducting the survey.

Quarterman North Cemetery

The second cemetery related to the Quarterman Family is north of Quarterman South and is also located along the two-track sand access road. The cemetery is fenced off from the surrounding forested area. The forest extends on the east, west and southern fence lines of the cemetery. The north boundary of the cemetery is free of floral intrusion but contains the pedestrian entrance for the cemetery and the termination of the access road. The area within the fence has been maintained and the landscape is comprised of grass and sand expanses typical of the other cemeteries in the survey. There are a number of isolated water oak and Sabal palmettos located throughout the cemetery. The largest of the water oak trees is located between and to the

west of the two concentrations of burial plots in the cemetery. One set of 2 burials are identified as belonging to George M. and Anna D. Quarterman. The second set has been described as a pet cemetery (Cantley 1994). The survey of this cemetery was divided into two distinct grids; grid 1 and grid 2 (Figure 23 and 24).

Quarterman North Cemetery Grid 1

Quarterman North Cemetery Grid 1 was established inside the cemetery proper. Due to the floral intrusion of the aforementioned water oak tree, the survey grid was offset 36 degrees east of magnetic north. This arrangement offered the best option for the survey. The physical dimension of the grid is 14 m by 7.5 m. The grid contains the burials that are arranged within the four concrete posts mentioned in Chapter 3. Other than the root mat intrusion of the water oak tree, the ground cover is comprised of grass and bare sand patchwork. This area is maintained by CCAFS.

Quarterman North Cemetery Grid 2

The final area surveyed at Quarterman North Cemetery is Grid 2 which is located outside the cemetery perimeter running parallel along the north fence line. The dimensions for this grid are 8 m north to south by 11.5 m east to west. Surface conditions in the grid area are similar to Quarterman North Cemetery with the presence of grass and extensive patches of loose sand. In particular, the eastern area of Grid 2 exhibits soil of a very loose compaction that is indicative of extensive disruption either caused by natural man-made (or a combination of both) activities.

There is no observable cultural evidence of burial activity in this area, and it is maintained by the CCAFS.

The tree line borders the east and west sides of Grid 2. Its canopy footprint and subsequent root mat intrusion is expected to impact the survey. This is also where the entrance and roadway to Quarterman North Cemetery are located. There were expectations this arrangement would influence the survey results. The roadway is not paved and requires maintenance, which modifies the surface and near sub-surface conditions. This is then reflected back to the GPR during the survey. These reflected traces must be documented and mitigated during the post-processing analysis for this grid. Additionally, since the entrance provides ingress and egress to the cemetery, the potential for reflective material, both by accident or design, becomes imbedded in the sub-surface and identified by the GPR as a geophysical target. In this case, the depth and spread of the geophysical feature must be mitigated for in the post-processing of the survey data

Burnham Cemetery

Burnham Cemetery, like all but one of the burial plots in the research, is located north of Quarterman North Cemetery between the Banana River and the south bound roadway of Samuel C. Phillips Parkway. Access to the cemetery is also negotiated by a sand two-track access road that runs perpendicular to the main parkway, leading to a right curve on the two-track roadway, past protected and secured Native American mounds, and culminating in the entrance to the cemetery. The entrance is located on the cemetery's western fence line.

Burnham Cemetery is enclosed by a chain link fence that creates a rectangle that is longer running north to south than east to west (Figure 25 and 26). An extensive forested area surrounds the cemetery. The majority of the trees are water oak and Sabal palmetto, and the canopy footprint extends along the boundaries of the cemetery. In the cemetery proper there are isolated Sabal Palmettos and one water oak tree located in the northern central area. The ground cover is grass with areas of patchy sand that is maintained by CCAFS. There are six burial plots arranged in a linear fashion. A concrete enclosure containing three burials is located at the north end of the cemetery (Figure 27). The remaining burials occur south of this enclosure and are arranged in family groupings (Figure 28). Of note is the fact that the area surrounding Burnham Cemetery is dotted with Native American mounds and middens. The cemetery itself lies upon an extensive midden complex with a number of historic burials intruding into this earlier feature.

Burnham Cemetery Grids Large and Small

The survey of Burnham Cemetery consists of two grids located in the southwest corner of the site (Figure 29). The western fence line is not a completely straight boundary. This necessitated moving the grid boundary 1 m east of the existing fence line to maintain a uniform western boundary to parallel the eastern boundary. The southern fence line is also not straight and does not run parallel to the northern fence line of the cemetery. This discrepancy required the grid be placed in such a way as to run parallel to the western boundary of the cemetery. To accommodate the gap in the grid along the southern boundary, another smaller grid was laid out to complete the survey. The larger grid is designated "Grid 1," and its dimensions are 31 m north

to south and 11 m east to west. The smaller grid, located to the south, is designated "Grid 1A." Its dimensions are 3 m north to south and 7 m east to west. Grid 1 contains sparse flora intrusions but has a number of clustered burial plots within its boundaries. Grid 1A has no observable flora intrusions or historic artifacts within its boundaries. The familiar ground cover of patchy grass and sand is present in the grids, and they are maintained by CCAFS.

Additional Cemeteries and Burial Plots

Additional cemeteries were originally included in the scope of this study. For various reasons they were ultimately excluded in the actual GPR survey. Wilson Cemetery, Penny Plot and the Osmon grave site had detrimental issues of size, condition and location that were impediments in conducting a GPR survey. Wilson Cemetery is located at the western side of Burnham Cemetery. The small size of this cemetery and the fencing around it proved to be limiting factors for use of GPR; the transects would be constrained by the fenced area of the cemetery and the electromagnetic interference of the fencing material itself removed Wilson Cemetery from consideration for the GPR survey. Penny Plot was ruled out as a candidate for the use of GPR because of its location in a heavily forested area. Finally, location and geology at the Osmon burial disqualified this site for the use of GPR; the burial is located on coastal sand dunes that would hamper the movement of the GPR unit. Additionally, the proximity of the burial site to the Atlantic coast would increase the effect of salt water intrusion in the surrounding subsurface likely ensuring the potential for "false" positive anomalous targets in a GPR survey.

Though these cemeteries were not used for the survey, they offered ethnographic and genealogical evidence that is included in the analysis.

CHAPTER 5: ANALYSIS

With the survey completed and the beginning of the post-processing analysis underway there was a need to understand expectations and characteristics of burials that were documented in other GPR surveys conducted at historic cemeteries. Anomalies that appear in the post-processed reflection profiles had the potential to be either man-made or naturally occurring. Naturally occurring anomalies can be roots of trees and plants as well as geological such as changes of soil stratigraphy in the sub-surface (Conyers 2006a:64; Conyers 2013; Conyers 2012: 142-144). Man-made anomalies can be pipes, foundations and burials to name a few (Conyers 2006a:200-204; Conyers 2012:81-84). In the case of burials, there were a number of characteristics that appeared in the reflection profiles. There can be a hyperbola that appears in the reflection profiles that denotes a reflective object or void (Figure 30 and 31). The hyperbola for a man-made anomaly can also be generated by roots of a plant, so additional characteristics must be used to verify a burial was present in the survey (Guo et al. 2013a; Guo et al. 2013b; Tanikawa et al. 2013; Wu et al. 2014). Orientation and depth of anomalous targets were indicators of whether or not a burial was present (Bevan 1991:1311; Conyers 2006; Isaacson 1999). Changes in the stratigraphy of the sub-surface soil as well as mixing of the soil column indicated that a burial shaft was present was another characteristic to look for in the post-acquisition analysis of the survey raw data (Bevan 1991; Conyers 2006a; Conyers 2012:79; Conyers 2013:107). These characteristics established the criteria for the following post-processing analysis of anomalous targets found in the reflection profiles of CCAFS survey.

Post-Acquisition Processing

The data compiled from the various Ground Penetrating Radar (GPR) surveys of Cape Canaveral Air Force Station (CCAFS) were processed using Geoscanners AB GPRSoft Pro software. This software offered a macro function for processing large data sets of GPR information. Macros are computer tools that were created to perform a number of computer operations that an operator installs in a template. In essence, the macro function provides a single template of one GPR slice profile to which ground surface, background noise reduction, filtering and gain enhancing were applied across the dataset to enhance the imagery. This macro was then applied to all the slice profiles of the data set. The dataset was used to craft a series of maps and informational sheets for use in mapping near-surface anomalous targets that occurred in the survey. The two techniques provided a complete picture of sub-surface conditions at CCAFS.

As has already been stated, the reflection profile was the two-dimensional image of what the GPR unit was recording of the structure in the sub-surface of the soil. These profiles were individual representations of each transect of a larger survey. The reflection profiles contained information that indicated targets or anomalies that were of interest to the archaeologist. Though useful, the reflection profiles were limited to an overall analysis of the sub-surface at a site. They only offered a single snapshot of a much larger picture.

Ground Penetrating Radar Reflection Profiles

There were a number of techniques, methods and software products used to create useful reflection profile sets to map CCAFS cemeteries. Suffice to say, there were many private and public sector texts written on the processing and post-processing analysis of GPR data, and without a doubt, this processing was of benefit to the analysis of the cemeteries. The macro function of GPRSoft Pro combined a number of important features to a single slice profile of a given data set. This macro slice profile became the template by which a universal filter array was added to the raw data set of the survey. In previous editions, software used in processing GPR slice profile data sets required individual filter steps be performed on each and every individual raw reflection profiles to “clean” the reflection profile.

All of the survey data sets for CCAFS’s cemeteries were analyzed and prepared in the same manner. For each cemetery survey data set, a macro was created using a single reflection profile. The same filters were applied to each reflection profile to create a macro. Though the macro was built using the same filtering tools, the variables in the filters were unique for each cemetery survey. Then, the macro was applied to the entire data set for that particular cemetery. Each macro processed began with a step to determine ground zero of the reflection profile. This adjusted the time-zero to correct for the passage of the electromagnetic wave from the antenna through the air between the bottom of the GPR unit and the ground surface. The adjustment made in the macro applied a common time-zero correction to all reflection profiles.

The next step was setting the high and low pass filters. This effectively reduced high and low frequency noise from the reflection profiles (Conyers 2013:129, 134-137). These frequencies were related to communication, electrical interference and human activity. The reduction of these frequencies enhanced the visual characteristics of the reflection profiles. Background removal was a process that allowed marginalized signals such as electromagnetic interference, neither related to nor produced by the GPR Unit, to be processed out of the reflection profiles. This had the effect of removing the horizontal banding that appeared in the reflection profile.

The final step required adjusting the gain. The function of gain visually enhanced the reflection profile (Conyers 2013:143-144). For deep-positioned geophysical surveys, the electromagnetic wave potentially weakened as the depth increased. This attenuation of the wave in addition to wave deflection, could may reduce the visual imaging and minimize target acquisition for the survey. With near surface GPR surveys, gain enhanced the image of the reflection profiles. The order of operation for which the macro was constructed using GPRSoft Pro on the selected reflection profiles for the creation of templates was variable with the exception of gain. The filters were applied first, followed by the application for gain functions that enhanced the visual characteristic of the processed reflection profiles and the horizontal slice overview map rendered for the analysis. The general and macro statistical information of the cemeteries and grids selected for survey can be found under appendices B thru K for each

cemetery and grid. Two large computer files house the original surveys and the processing done on CCAFS. Each file will be indicated in the forthcoming descriptions.

The description of each cemetery and grid processed addressed the characteristics and problems encountered in analyzing the post-processed reflection profiles. Each description included maps that show the overview of the surface, the beginning of anomalies, the termination of anomalies and side and end profiles. The rest of the description consisted of transect location, top and bottom depth and length of each anomalous target in the cemetery or grid. A designation was given to each anomaly that included survey location and figure identifiers. This information was finally compiled in a list with additional information to indicate the anomalies' particular characteristics. This list is located in APPENDIX O.

Reflection Profile Point Plot Mapping

One aspect of reflection profile mapping was the volume of data the process was rendering. The advantage of this type of mapping was electromagnetic connections were shown in space. A good example for this was the presence of vaults in the sub-surface of a cemetery; the void that vaults created was shown clearly by the returning electromagnetic waves that the GPR unit records. However, in the case of CCAFS cemeteries, the anticipated target of unknown graves was difficult to represent and analyze completely due to the presence of biological and geological background "noise." This "noise" was eliminated using a simple point plot mapping technique that is fundamental to all archaeological work.

The survey of the cemeteries of CCAFS produced reflection profiles that, as stated before, were used to construct the horizontal slice overview. In constructing the point plot maps for each cemetery the same reflection profiles were used that were utilized to produce the horizontal slice overviews. The first step to building a point plot map was creating a large block grid map where each block had a scale of one centimeter being equivalent to one meter. Each centimeter block was further subdivided into 100 millimeter blocks. Division of the blocks in this manner allowed for the best format scheme to represent each anomalous target occurring in each reflection profile along a given transect (Figure 32).

Each cemetery was systematically and manually plotted in the same manner. In addition to the point plot maps that documented the characteristics of each transect of each cemetery or grid surveyed, an accompanying informational sheet was produced. The identity, location and depth of each anomalous target were recorded on this informational sheet, as well as any anomalous geophysical targets such as stratigraphic discontinuities or unusual geologic features. Any data or processing issues were outlined according to each cemetery.

The following analyses for each cemetery or grid surveyed were based on the reflection profile point plot maps. It should be reiterated that geophysical targets located by the GPR unit cannot be specifically identified unless excavated. Because this was not possible in historic cemeteries, any concentrations of geophysical targets located within the confines of CCAFS cemeteries will be designated as features. The concentrations of geophysical targets were based

on the data gained from the GPR survey, and then correlated with existing information and data about the cemeteries to form a sub-surface geophysical map of the cemeteries and grids.

Once the features were designated they were analyzed for burial activity. To do the analyses of a feature the expected characteristics were established for a burial. These characteristics conformed to known Christian burial practice. The length of 2 meters, the width of 1 meter and a depth of 2 meters was the physical dimensions used as an expected characteristic for a burial. The orientation of the geophysical targets was another expected characteristic used to identify a potential burial. The mitigation of biological intrusions was used to provide an expected characteristic to interpret anomalous targets in feature areas as burials. Finally historical sources were reviewed for corroborating evidence of burial activity in a feature area.

Cape Road Cemetery

The survey was conducted on two consecutive days in August 2011. The conditions were dry and the temperature was between the mid-80s to low-90s. During the first day of the survey, numerous adjustments to the GPR unit and the computer were made. The GPR unit was calibrated to sub-surface conditions using a buried iron pipe whose depth could be manually measured (APPENDIX B). The first part of the survey covered a total of 35 transects. The dimensions of the first grid were 13 m by 34 m. Transects 1 to 4 were used for calibrations of the GPR unit. The actual survey began at transect 5 and continued to transect 35.

Transect 5 began at the 0.5 m mark with each subsequent transect interval at 0.5 m. The

first transect was recorded heading north followed by the second transect being recorded heading south. This movement was repeated for all subsequent transects in this survey on both days. The second day of the survey presented conditions similar to the previous day with the exception that it had rained the night before. The survey continued as the day before but started with a new file designation. The iron pipe was again used to calibrate the GPR unit (APPENDIX C). The survey began with transect 11 and continued in the same physical survey pattern as the first day. The last transect of the survey was transect 75. The dimensions of the surveyed area for day two were 26.5 m by 34.4 m. There were a number of corrupt files that were removed during the processing that produced the horizontal slice overview. The initial attempt to create a combined and complete horizontal slice overview proved unsuccessful. Data processing for each day's survey did produce a horizontal slice overview, so post-processing analysis was conducted on each grid separately.

The post-process analysis for Cape Road Cemetery and all subsequent cemeteries and grids began with viewing the reflection profiles generated by the survey. Identification of existing burials provided the expected characteristics for the unknown burials. The reflection profiles also provided the potential depth of burial activity and the base level for the post-processing of the horizontal slice. This level was established at 2.5 m level below the surface time zero. The decision to start the analysis at this depth was based on the understanding that historic burials would not register below this point because of the physical structure of the grave (Conyers 2012:58, 79). Consideration of the coastal and geological environment of Cape

Canaveral also set depth restrictions on burials because of the possibility of high water levels, salt intrusion from the ocean and soil sediments (Conyers 2012:65-66, 70-71). These principles were applied to the entirety of the post-processing analysis of the CCAFS GPR survey.

Cape Road Cemetery had 22 recorded burials. The individual locations of these burials were discussed here. The reflection profiles for the majority of the burials were along transect 71 of day 2 (Figure 33). The geophysical targets indicated were, from left to right, the Jeffords family burial, the Hardin family plot and the Jandreau family plot. Samuel Jeffords had a granite capstone with concrete coping over his grave, while his son Joseph's grave was marked with concrete coping and a headstone. The southern end of transect 71's reflection profile revealed the foot prints of the double granite headstones of the Hardin and Jandreau family burials. The reflection profile showed the near surface geophysical footprint of the surface headstones and boundary features of these graves. As indicated in figure 33 and represented on the point plot survey site map in figure 34 there were a series of distinctive geophysical targets evident in the location of the Jeffords family burial. Also indicated beneath Busie Carlisle, the reflection profiles show a small number of geophysical targets and may indicate remains of the his burial equipment (Figure 35).

During the second day of the Cape Road Cemetery survey, two burials marked with modern wooden crosses were found along transect 39: Margarett E. Lelasky, an adolescent female and John Easterlin, an adult male. There was an intense source of electromagnetic reflection on the southern end of this transect (Figure 36). These graves were located in a swale

at the lowest elevation of the cemetery. There was the possibility of the presence of another grave in this area belonging to Ben Lewis, a local postmaster (Wentworth 2000). Based on the spread of geophysical targets there, it could be reasoned that a number of burials were present.

The reflection profile point plot maps add a layer of information to the survey of Cape Road Cemetery (Figure 34). The near-surface point plot map of the cemetery shows seven concentrations of geophysical targets. Three of the features were situated in the same spatial arrangement as known burials (CRC A, CRC C, CRC G), one had a locational relationship to both bioturbation agencies and a known burial (CRC B), another was beneath a palmetto stand (CRC E) and finally the remaining two had no obvious relationship to either burial activities or biological processes (CRC D, CRC F) (Figures 37 and 38).

Feature CRC G had a relationship to the Jeffords family plot. The feature showed the probable burial spot of Busie J. Carlisle. This individual was the youngest child of Samuel Jeffords and his first wife, Julia. Feature CRC C may indicate the burial plots of Margarett E. Lelasky, John Easterlin or Ben Lewis. John Easterlin, the husband of Busie J. Carlisle, may in fact be located to the north and beside Hubert Wensley Syfrett. Syfrett is the younger brother of Samuel Jeffords's third wife Lillian "Catherine" Syfrett (Wentworth 2000).

Feature CRC B is the feature that had both a biological and a burial relationship. The burial spot of Allee Whidden and Willoughby Whidden was located to the east of the feature but there was also a Water Oak tree to the west of this geophysical anomaly. CRC A was north of the previously mentioned feature and could encompass the burial of other Whidden family

members. Records state that Kate Morgan's aunt and "some Whiddon's" were buried in that section of the cemetery (Wooley 1998).

Feature CRC E did not have an obvious connection to any specific burial, but it should be noted that there were concentrations palmettos to the northwest and south east which were indicated in the geophysical record from the survey. When the point plot map was created there was an east/west orientation of the anomalous targets which previously was considered a characteristic of a burial. The length and width of the anomalous targets corresponded with established characteristic linear dimension for a burial. The potential for flora intrusion that border CRC E was a concern in hypothesizing the area as a burial. That coupled with the lack of historic documentation provided a counter argument for the presence of a burial.

The remaining features CRC F and CRC D had anomalous geophysical targets not related to the biological or burial activities. Of the two features CRC D had the characteristics to be an unknown burial (Figure 38). There was an east/west orientation of the anomalous targets and the concentrations of reflective targets were characteristic of a burial. The depths of the targets also indicated this area could be a burial. The fact that floral intrusion was limited, based in part to the size and dispersion of the trees in the area, allowed for the hypothesis that a burial could be present. The one factor that was not in agreement was the historical references. Though this area of the cemetery had a large number of burials the historic record doesn't indicate any other burial activity than what had been noted previously (Figure 34).

The anomalous targets of CRC F also conformed to the previously mentioned characteristics of a burial. There was an east/west orientation of the anomalous targets and the concentrations of reflective targets hypothetically could be that of a burial. CRC F was located 6 meters to the west of the CRC C which ruled out any overt links between these areas. Also no floral intrusion was present to account for the anomalous targets. Historically there were indications of a burial based on anecdotal evidence (Wentworth 2000). The one problem with hypothesizing a burial was present in CRC F was the amount and dispersion of the anomalies in the target area. This area had just three anomalies. Two of the anomalies processed an east/west orientation but the distance between the targets was over 1 meter. The spatial relationship of the three anomalies targets limited a hypothetical argument in favor for a burial in feature CRC F. As stated previously, though there were graves that were related to geophysical targets in the point plot map, the lack of consistent geophysical targets for all the surface headstones must be noted.

Cape Road Cemetery Grid 2

Cape Road Cemetery (CRC) Grid 2 was surveyed twice. The transect interval of the first survey was 0.5 m, while the transect interval of the second survey was 0.25 m. A substantial amount of time elapsed between the two surveys. The transect interval (0.5 m) calibrations and environmental conditions for CRC Grid 2 were the same for both surveys done in August 2011 (APPENDIX D). The second survey was conducted at 0.25 m transect intervals in January 2013 and used the original iron pipe for calibrations of the GPR unit (APPENDIX E). In the first

survey there were a total of a 112 transects with the dimension of the grid 20 m by 39.5 m. The second survey had a total number of 168 transects (Figure 40).

The same parameters were in effect for this analysis as previously stated. The difference between surveys was in the transect intervals. Analysis of these grids offered two objectives: first, to satisfy that no unknown burials were located in the grid and second, to corroborate and possibly enhance the analysis by decreasing the transect interval. A geophysical anomaly appeared in both the 0.5 m transect interval and the 0.25 m transect interval (Figure 41). The reflection profile indicated that it was a locus of high electromagnetic reflectivity but not a burial. CRC G2 B did have the east/west orientation that was characteristic of a burial. The dimension was 1 m in length which was also a characteristic of a burial. There were only two anomalous targets in the area that were linear but was a small concentration of targets to hypothesize that a burial was present. More conclusive evidence was a comparison of the calibration pipe in figure 30 to the anomalous target in figure 41. Because of the low count of anomalous targets in CRC G2 B and the comparisons of what the reflective profile signature of a pipe was in an adjacent survey grid the conclusion was this was a pipe.

The point plot map for Cape Road Cemetery Grid 2 did show five areas of geophysical targets (Figure 40). All the features had a straight line progression from west to east. There were five geophysical targets dispersed in the survey grid area. Feature CRC G2 B was the longest of these with a length of 5 m. The remaining features; CRC G2 A, CRC G2 C, CRC G2 D and CRC G2 E had only two geophysical targets in their feature area. Transect 54 located in

CRC G2 C does displayed a defined hyperbola (Figures 42 and 43). There was only one other anomalous target in the feature area. The geophysical targets in the feature areas displayed the east/west orientation but had a separation of 50 cm (Figure 44 and 45). The depth was also problematical though CRC G2 C feature area had anomalous targets that were well placed to make a case for a burial (Figure 45). Also in the case of CRC G2 C the presence for a burial was strengthen by the hyperbolas in transects 53 and 54, because these anomalous targets displayed an east/west orientation and spatial relationship for a burial (Figures 44 and 45). It should be noted that CRC G2 D has a strongly reflective anomalous target (Figure 45). But as was the case with the other features in this survey grid, the low concentrations of anomalous targets coupled with the lack of historical documentation made it difficult to hypothesize burials conduct in CRC Grid 2.

Quarterman Cemetery South

Three individual grids were the focus for data processing for Quarterman Cemetery South. These grids were analyzed separately. Grid 1 was the fenced area of the cemetery itself. Grids 2 and 3 bordered Grid 1 (Figure 46). All three surveys were conducted on the same day, and the GPR unit was uniformly configured for each (APPENDIX F, G and H).

Quarterman South Grid 1 was the first survey conducted on the cemetery. There were five feature anomalies noted in the reflection profile and point plot maps. Two features can be explained as floral root mats (Figures 47 and 48). Two features were close to a known burial (Figures 47 and 49). These features lie on a east/west axis but only had one anomaly alone 2

transects and connection to a burial was tenuous at best (Figure 49). Though the area had headstones, there were no indications in the mapped overview that there were any anomalies directly associated with burials (Figure 49). One feature, QSG1 A, had two target anomalies resting on a north/south axis but were not associated with either biological or burial activities (Figure 50).

Grid 2 also had five anomalies within the boundary of the grid area (Figure 46). The feature's location and depth indicate biological activities as an explanation for the existence of the geophysical targets recorded by the GPR. Feature QSG2 A had an east/west orientation and was centered on the southern edge of grid 2 (Figure 51). There were single anomalies located on the southern end of adjacent transects. The two features, QSG2 B and D, had the burial characteristic of an east/west orientation and also had no obvious biological intrusions. Of the two, QSG2 B had marginally higher concentrations of anomalous targets (Figure 51). Though both features anomalous targets consisted of single reflective points located on adjacent transects, QSG2 B had a length of 1 m that typified as a burial characteristic. QSG2 E was the one feature area that did not display the any characteristic of a burial (Figure 52). The concentration of three individual anomalous targets on adjacent transects were dispersed in such a way as to precluded them being associated with a burial. Also directly opposite and along the west side of the feature was a tree that lent evidence to indicate the root structure was what the GPR had detected in this feature area to produce anomalous targets. The final anomalous feature, QSG2 C in the center of the grid, could not directly be linked to biological processes.

This feature had an east/west burial orientation that was located in a linear isolated cluster with no obvious outlying anomalous geophysical targets connecting the feature to any of the other features or floral elements in the locale environment. The length of the individual anomalous targets located on adjacent transects provided credible characteristic evidence, as outlined previously for burial activity (Figure 53).

Grid 3 was the final survey area for Quarterman Cemetery South. There were two isolated features in this grid. The proximity of Grid 3 to the forest edge offered the best explanation for the anomalous targets that appeared in the reflection profiles and map. Each feature occur in two transects only and they had an east/west orientation. There were a number of isolated geophysical anomalies but no patterns for burial activities were apparent in the survey data.

The reflection profile point plot maps revealed few concentrations of geophysical targets in comparison to Cape Road Cemetery and Burnham Cemetery. Two of the grids exhibited at least one area that could be identified with burial activities, but those areas also had faunal or potential man-made intrusions that prevented characterizing the feature as burials. In Grid 3 there were two features of note. QSG3 A and B each had two individual anomalous targets located on separate transect and they had a linear east/west relationship. Although QSG3 A had the correct orientation for a burial, the proximity of the two-track road, location of the grid at the entrance to the cemetery, and the abundance of trees in the area was sufficient to rule out the geophysical targets as a burial (Figure 54). In general, all three grids showed neither distinctive

geologic disturbances nor stratigraphic discontinuities. These characteristics led to the assumption that, at least in the vicinity of the cemetery, the construction of the military launch facilities on the eastern side of Cape Canaveral did not impact the homesteads on the western side of the Cape.

Point plot maps of Quarterman South Cemetery provided no clear evidence of burial activity beneath the headstones of Mary A. Quarterman and Vernon Quarterman. The headstone for W. G. M. “George” Quarterman was a modern addition to Quarterman South Cemetery. Wentworth’s description of the cemetery in 2000 made a passing reference to Mary and Vernon Quarterman (Wentworth 2000). The cultural resource survey conducted in 1994 mentioned that family members believed George was buried at Quarterman South Cemetery (NPS 1984). There was also a problem in the identification of the infant burial located beside Mary Quarterman. Though Wentworth documents offered the name of Vernon for the burial, other sources such as the aforementioned CRM reported name the child "Vercina" instead (Wentworth 2000; Charles et al. 1994). In creating a burial genealogy for Quarterman South Cemetery for this thesis, the infant was identified as a descendant of George and Mary Quarterman based on the legible last name on the head stone and the proximity to Mary’s grave.

Quarterman Cemetery North

Generation of reflection profiles and maps for the Quarterman Cemetery North was straightforward. There were no survey transect issues to mitigate during the reflection profile processing (APPENDIX I). In fact, Grid 1 and Grid 2 required no pre-processing “cleaning” of

the raw survey data. The post-processing analysis, however, was more challenging due to the location and bio-intrusive nature of the surrounding forest root mats. Grid 1 was located within the bounds of Quarterman North Cemetery (Figure 55). Although the military has maintained the landscaping inside the cemetery, there were a number of trees that impacted the grid area. Quarterman North Cemetery Grid 2 was located on the border of the cemetery but outside of the fence of the cemetery proper. The area had been cleared, yet there were several tree stumps in the grid area.

Grid 1 of Quarterman North Cemetery had the typical electromagnetic anomalies also found at the Quarterman South Cemetery. Both Quarterman South and Quarterman North cemeteries were surrounded by forest. Although there were two grave markers in Grid 1, the reflection profile registered four geophysical targets along transect 7 but not directly beneath the markers (Figure 56). There were geophysical anomalies but they were individual and isolated from each other. The examination of the Grid 1 reflection profiles revealed that the concrete posts are not plainly differentiated from the surrounding sub-surface electromagnetic reflections.

Grid 2 of Quarterman North Cemetery had far less anomalous targets in the same subsurface zone as Grid 1. Conditions on the surface of this grid predicted extensive floral intrusion in the grid sub-surface. The proximity of stands of oaks and pine trees on the eastern and western edges of Grid 2 coupled with tree stumps in the survey area provided the evidence to explain what anomalies were present in the reflection profile. Along QNG2 transect 10 the sub-surface anomalous targets are within 2 meters of a Pine tree stump removed for the survey (Figure 57).

Burnham Cemetery

There are two grids that comprise the Burnham Cemetery survey area. They were adjacent to each other along the south fence line. The Burnham Cemetery survey was conducted using uniform GPR calibrations and sets (APPENDIX L and K). Burnham Cemetery Large Grid comprised the bulk of the survey area, while Burnham Cemetery Small Grid covered a smaller area between the Larger Grid and the southern fence line of the cemetery. Pre-processing for each grid was minimal requiring no “bad” transects to be cleaned from the GPR survey files. Processing for the reflection profiles followed the same procedures as outlined for previous grids. The methodology for surveying the smaller grid added processing steps to generate the reflection profiles. Transects 45 to 50 followed the normal back and forth survey pattern of all grids up to this point. Transects 51 to the end of the grid at transect 58 were surveyed traveling in only one direction, south, due to the size and shape limitations of the small grid. These conditions meant that two maps were produced for use in the post-processing analysis (Figure 58).

Burnham Cemetery offered an opportunity to discover unmarked graves. One group of burials and an two isolated burials in the Large Grid area were surveyed in the course of the survey. The group burial, which was comprised of Burnham and Wilson family members were indicated by surface headstones. One grave was constructed of cement and was readily identifiable in the reflection profile (Figures 59 and 60). This provided a reference to locate the other graves positioned along this transect on the point plot map. The isolated infant burial was

not clearly indicated in the reflection profile (Figure 61). Mills O. Burnham's cement and brick burial slab was not obvious in the reflection profile but his daughter and son-in-law's burial site appeared in feature area BFC F. The location of the Butler burial was obscured by the geophysical footprint of the palm trees in the vicinity of the grave. This was true universally throughout the Large Grid and of significance under the identified burials. Since the location of Burnham Cemetery was on a prehistoric midden, it was assumed that the midden material would maintain the outline of the grave shaft better than that of the sandy conditions at the other cemeteries and grids. The smaller grid attached to Burnham Family Cemetery survey is called Burnham Cemetery Small Grid. To complete the survey and mitigate the southern fence required the division of the grid into two areas. The GPR survey of the Burnham Small Grid revealed no geophysical anomalies.

The reflection profile point plot map of Burnham Cemetery showed that this cemetery had the largest number of geophysical targets (Figure 58). The Large Grid area for Burnham Cemetery had a total of ten geophysical anomalies. The point plot map, reflection profile point plot descriptions, survey field notes and photographic evidence were instrumental in selecting the ten areas of geophysical interest within the Burnham Family Cemetery Large Grid (Figure 62).

There were three areas that dominated the survey area in the Burnham Family Cemetery. Features BFC D, BFC F and BFC J had a large number of geophysical targets. They also had small clusters of anomalies with an east/west orientation but the overall dispersion of the

anomalous targets in BFC J and for that matter BFC D and F did not have the expected characteristics of a burial. They had biological intrusions from the surrounding forested area with feature BFC F being the only area that overlapped existing burials. The location of BFC J along the eastern edge of the survey grid offered the chance for root intrusion. BFC F, though in a similar location as BFC J, also had the burials located in the feature area. There was the characteristics east/west orientation of four anomalous targets within BFC F that was lacking in BFC J. With BFC J's proximity to the western edge of the cemetery and the surrounding forest for the anomalous targets recorded in the GPR survey (Figure 63). BFC D also had a diffused cluster of anomalous targets. There were two areas within the feature that had an east/west orientation that were characteristic to burials but the depths of those anomalies suggested biological intrusion (Figure 64). Though BFC D was located in the central portion of the survey area the hypothesis for biological intrusion could be propagated by comparing the reflection profile of transects that contained both a burial and a tree along its length. Transect 13 ran along the western edge of four burials of the survey and transect 39 that was bisected by and oak tree (Figures 65 and 66). As indicated in Figures 65 and 66 the burials had a different geophysical characteristic. The depths of the geophysical targets for the tree roots in Figure 66 were similar to those in BFC D. It is then logical to hypothesize that the dispersed anomalous targets in BFC D were related to biological intrusion. This hypothesis is valid for the other features in the survey area that did not have the characteristic features of burials as outlined previously in this chapter.

Features BFC B, BFC C, BFC E and BFC G were biological in nature. The location of BFC E and BFC G on the southern side of a medium size tree established a case for bioturbation in defining the recorded anomalous targets (Figures 65 and 67). To hypothesize that floral intrusion accounted for the anomalous targets located in features BFC B, BFC C and BFC H was problematic to prove with certainty. All three of the features had an east/west orientation characteristic. In the case of features BFC B and C the characteristic dimensions for a burial were observed.

In postulating that root intrusion and not burials were the anomalous targets recorded in the survey, the characteristics of a burial must be used. These features had the characteristic spatial length and orientation. Since the survey was set to run transects perpendicular to the burial orientation and the transect interval was set at 25 cm, the expectation was multiple geophysical targets, if present, would be recorded as anomalous. This would be the optimum in practice that didn't have a guarantee in GPR practice (Bevan 1991, Conyers 2006a; Conyers 2013:15-16). Because of the climatic conditions and age of the cemetery there would be very little left of any of the burial artifacts (Conyers 2006a; Conyers 2012: 129-139). This being the case, the one remaining characteristic was the burial shaft. The burial shaft, if the soils were stratigraphic and reflective, could be differentiated from the surrounding soils in the reflective profile (Conyers 2012: 139). Since Burnham Family Cemetery was located atop a shell midden, due to the compact nature of the soil, prospects were good to detect a burial shaft in the reflection profiles. The excavation of the burial shaft and subsequent reburial would leave

anomalous targets seen in the reflection profile Conyers 2012: 139). In the case of BFC B and C there was no indication of a burial shaft in the reflection profile (Feature 66).

Features BFC A and BFC I were of particular interest (Figures 64 and 65). These two feature areas had limited root intrusion. The features had the east/west orientation with multiple geophysical targets. The clustering of BFC A electromagnetic targets offered the better potential for a burial than did BFC I, but neither should be ruled out as a potential unrecorded grave. One remaining feature area, BFC H, had an east/west orientation but the target only occurred twice within its boundaries (Figure 68). Though the expectation of multiple anomalous targets in reflection profiles were optimum for post-acquisition analysis, other conditions must be used in establishing a burial was being recorded in the raw data (Bevan 1991; Conyers 2006a; 2012: 129-139). The location of this feature on the edge of the survey area restricted the information that could be gleaned from the reflection profiles.

Discussion

A picture emerged of the cemeteries on Cape Canaveral upon compilation of all the elements of this thesis. Although historical specifics were recorded about these cemeteries, determining if there were missing parts to the story was harder to discern. Geophysical surveys and in particular, Ground Penetration Radar (GPR), were useful tools to search for sub-surface anomalies, but guaranteed no definitive answers. The GPR survey confirmed the locations of burials that consisted of building materials such as brick and concrete coping, granite and marble headstones and underground vaulting.

Referencing Table 9, each feature was evaluated for burials using the geophysical targets found in the survey. The table also noted the concentration of geophysical anomalous targets present in the feature area to confirm a burial had occurred. The end result of this analysis provided the basis for speculation on the presence unknown burials. This assumption was linked to the geophysical targets, the concentrations of the targets, the alignment and the expectation of burial characteristics in identifying a burial was present. Features CRC A, C and D in Cape Road Cemetery provided evidence for multiple burials. Feature BFC A in Burnham Cemetery and Feature CRC D in Cape Road Cemetery were probable for single unknown burials. Quarterman South Grid 2 also had a favorable anomalous geophysical signature of a unknown burial but location next to road access to the cemetery recommended caution in asserting that claim. The remaining features had anomalous targets that were located within their boundaries. The anomalies were either single geophysical targets with no corresponding relationship to any other geophysical target or there were concentrations of geophysical targets that were spatially related but did not conform to the established burial characteristic outlined in the previous sections or other characteristics of the grouping could not be related to a typical burial.

The areas of geophysical interest were present in the reflection profiles. But there were areas in the cemeteries that show no evidence of ever having been used for burials. Does this rule out finding burials in other parts of these cemeteries? Not necessarily. Upon consideration of the location of these cemeteries, an explanation was available. The environment of Cape Canaveral was and had been impacted by a number of natural agencies that changed how the

surface and the subsurface appeared in a geophysical sub-surface over time. The surface features of the cemetery could change over time due to additional burials, environmental conditions and maintenance. Additionally the length time between the burial and the survey was important to note. The range of time of the burials at the CCAFS, 142 years at Quarterman South Cemetery to 62 years at Cape Road Cemetery, meant much of the burial equipment had degraded or been completely assimilated into the surrounding sub-surface, rendering detection by GPR problematic. This being said, as the homesteads of Cape Canaveral grew from frontier settlements to established communities, the cemeteries reflected that growth. But the possibility existed that not all burials were recorded in governmental records. Times of war, natural disasters and changes in societies were events that interrupted the normal bureaucratic activities of governments. These conditions were prevalent during the American Civil War. Cape Canaveral was a Union Army outpost at the beginning of the war. The lighthouse located on the peninsula was dismantled at the start of hostilities by Lighthouse Keeper Miles O. Burnham. Family biographies divulged that Burnham buried the components of the lighthouse and then withdrew to his homestead until hostilities were concluded. The 1860s was also a time of change to the existing economic order of the south. The emancipation of the slave population changed the societal dynamics of the region. According to the United States Census of 1860 there were slaves at Cape Canaveral. During this time it is possible for burials that were performed but not recorded because of the social status of slaves in the south. Because slaves were property they would be buried by next of kin and not by their owners.

To explain the inconsistencies in the geophysical record for burials on CCAFS, it is proposed that environmental conditions and the span of time of the burial can account for the lack of geophysical targets beneath all the known burials (Bennett et al., 2009; Bruland and Richardson; 2005; Davis Jr. et al., 2003; Davis III et al., 2004; Hepner and Davis Jr., 2004; Lago et al., 2010; Neal, 2004; Smith et al., 2009). The settlers of Cape Canaveral selected this site to homestead for a number of reasons. The homesteads situated between the Atlantic Ocean and the Banana River had convenient access to transportation and subsistence resources. Protection was another benefit, considering the history of the Burnham family during the Second Seminole War when they were afforded time to escape any repeat of the violence they were exposed to in the past. But the security, environment and convenience of the Cape for the settler's homesteads did not penetrate far beneath the landscape that their cemeteries occupied. The location of the Cape guaranteed that subsurface geology and hydrology would impact the final resting places of their loved ones.

As with all landforms that occupied ecological boundary zones, the environment forces could influence these areas in varying degrees. Cape Canaveral was a peninsula, but it was better characterized as having traits of a barrier island. Fine-grained sand particles that create sand dunes occurred along the length of the cape. The subsurface geology consisted of relic sand dune formations with an over burden of deposits of heterogeneous sands and clays. The location of the Cape in a coastal margin gave rise to an interconnectedness of subsurface water flow, surface water and atmospheric precipitation. The absorption and flow capacity of the soils of the

Cape allowed for all the aforementioned agencies to remodel the surface and subsurface of the peninsula. This was particularly problematic for cemeteries. Maintenance of the cemeteries on Cape Canaveral required accurate geo-spatial recording of the graves and continued preservation of the burial markers. In the case of a hurricane, the twin threats of wind and storm surge could wreak havoc on grave markers. If the cemetery was in use, returning the markers back to their original positions would not be difficult. There was an obvious assumption that grave makers and the burial beneath were linked. It can be conjectured that one element of a burial, the grave marker was affected by the surrounding environment. But in analyzing the GPR data from the survey, it was necessary to look at the burial not as a singular unit of headstone, burial shaft and burial container but as distinctive and separate parts. All were affected by conditions in the environment they occupied. This also impacted the analysis of the GPR data for the cemeteries.

The surface maps of the cemeteries of Cape Canaveral recorded all the headstones on the ground surface, but failed to provide conclusive evidence of the burials beneath all of them. The age and historical information indicated that vaults were seldom used, at least not in the designated survey areas. There were limits to what the GPR surveys could record. Metallic objects, hard stone artifacts, changes in subsurface stratigraphy and voids caused by air were a few of the items that would register in a survey. Artifacts organic in nature were very difficult to see (Conyers 2013). Human bone was also invisible to the electromagnetic waves of GPR.

In the case of the Cape cemeteries what was not seen beneath the grave markers was indicative of subsurface conditions that absorb and remove the usual geophysical reflective

targets that register with GPR. Including consideration of the seasonal cycles of precipitation, cyclonic activity of Florida and the passage of time since burials had occurred, I assert that material and activities that generate geophysical targets would not consistently be present. Since there was limited use of vaults in the surveyed area of the Cape cemeteries, the assumption was the caskets and the metallic hardware, over time, would deteriorate to such an extent that the hydrological action would effectively remove evidence of them. The burial shaft would also be affected by the environment of the Cape, blending that feature into the surrounding stratigraphy. The homogeneous and porous nature of the subsurface soils and the lack of clearly defined stratigraphy would render detailing the burial shaft edges difficult to visualize in the reflection profiles especially since backfill is likely to be identical to the surrounding sediment.

The post-processing analysis for the CCAFS survey revealed a number of interesting characteristics of the sub-surface. The first indication in the reflection profiles for geophysical anomalies emerged at 155 cmbs. With the exception of the Burnham Cemetery Large Grid, which provided evidence for anomalies at 170 cmbs, all other cemeteries and grids in the survey sample registered anomalies at equal to or less than 155 below ground surface. Inverting the progression of the analysis of the reflection profile mapping, the geophysical targets increased in density as the surface of the grid was approached. At 75 to 40 cmbs, the density and magnitude of the geophysical anomalies increased. This zone was related to the biology of the survey areas. From 40 cmbs to the surface, the geophysical anomalies in the reflection slices increased in density. CRC Grid 2 had one isolated area (CRC G2 A) where the anomalies were distinctive

compared to the surrounding area. No large trees grew in the survey area. Therefore, this anomalous target was not natural.

The decision to conduct the analysis from 2.5 m below surface was based on the societal convention that the base of the burial would be at least 1.8 to 1.9 m deep. It was possible to anticipate a slightly deeper burial, but it would be below the 2.5 m starting point for the analysis. In every grid analysis, 2.5 m below surface were sterile of any geophysical anomalies. Approaching 1.7 to 1.5 m below surface level, the anomalies appeared but these were not located below the established and known burials. Given this information, the analysis shifted to focus exclusively on the burials. No anomalies were present until the 75 cmbs mark. This characteristic was illustrated by the two graves located in the Burnham Cemetery Large Grid. The electromagnetic wave passed through and around the burial and its geophysical footprint ends at the 1.3 m mark. There are no other geophysical targets below that level. The Burnham burials were the most distinctive of all the known burials in the geophysical record of CCAFS, but all of the anomaly's characteristics were uniformly disappeared by 2.5 m below the surface. This indicated local environmental conditions were impacting the known burials. It can be deduced that unmarked burials were susceptible to the same environmental conditions. It cannot be assumed, however, that burials did not occur simply because they did not appear in the geophysical record.

CHAPTER 6: CONCLUSION

The purpose of the research conducted for this thesis was the practical use of Ground Penetrating Radar to survey in a coastal environment to locate unknown burials. Cape Canaveral Air Force Station was the site selected for this study. Conditions on this site offered a variety of challenges for GPR. Situated between the Atlantic Ocean to the east and the Banana River to the west, Cape Canaveral offered an environmentally active landscape to survey. The sub-surface was equally challenging with a relic sand dune landscape serving as the foundation for CCAFS. The Cape offered a juxtaposition of the forces of development that dominate Florida today with those that settled this coast in the nineteenth century. The focus of the GPR survey was locating unknown burials in cemeteries that these homesteaders used to bury their dead.

The GPR surveys produced reflection profiles of the geologic sub-surface that highlighted geophysical anomalies that occurred in the homesteader cemeteries. These overviews showed an abundance of anomalies that were related to the biology of Cape Canaveral. The known burials of the cemeteries were also illuminated using GPR, thus proving the practicality of this technology in a coastal environment. The hydrology and geology at the near sub-surface of the Cape did not factor into the effectiveness of GPR. However, attempts to locate anomalies that might be unmarked burials in the reflection profiles proved more circumstantial.

Though a GPR survey cannot specifically locate unknown burials at Cape Canaveral, it appears that there are geophysical targets that suggest burials are present. Since there were

inconsistencies in the geophysical data beneath known burials, it is fair to conclude that a headstone is not the only indicator for burial. The number of concentrated geophysical anomalies that are grouped as features in the point plot reflection profile maps provides both the ending point of the survey and the beginning for new research. Based on the expected burial characteristic along with the post-processing analysis of the raw survey data there were seven feature areas that had the potential to be burial related (Table 9). There were three features in Cape Road Cemetery, two features in Quarterman South Cemetery and two in Burnham Family Cemetery. This fact offers guidance for the cultural management of these cemeteries. It would be advantageous to survey the areas in and around the homesteads systematically to document any and existing cultural artifacts. It would be advisable to use this GPR survey as a starting point and then utilize other geophysical methods to continue the research on Cape Canaveral. Additional methods for geophysical survey such as seismic reflection imaging (SRI), magnetic mapping and resistivity profiling, to name a few, compliment what GPR records and will enhance the findings of this thesis.

With further analysis of the known graves, the evidence for time and environmental impact offers an explanation for the absence of geophysical anomalies under known burials and a direction for further study. The assumption that a single headstone denotes a burial is a tenuous hypothesis, but if that headstone appears in a group it becomes plausible to state a burial is present. Understanding how environment and time impact burials experimental research involving various materials along coastal margins would yield useful information for researchers.

At Cape Canaveral, the known headstones should yield some geophysical anomalies to prove that a burial is present. In the post-process analysis of this survey, however, there were instances that some headstones did not have an extensive concentration of geophysical targets to denote a burial while others did. Does that mean that nothing was buried or does it mean there are other agencies at work that remove the physical evidence of burials? The environmental, geological agencies and the length of time the burials occurred offer mitigating processes for the lack of geophysical targets at known burials, as well as the opportunity to study the effect that these processes exert on burials over time. Long term experimental burials in coastal margins, if undertaken, would provide useful information on the effects coastal environment and interred burial chronology have on the geophysical record of historic cemeteries.

APPENDIX A: FIGURES

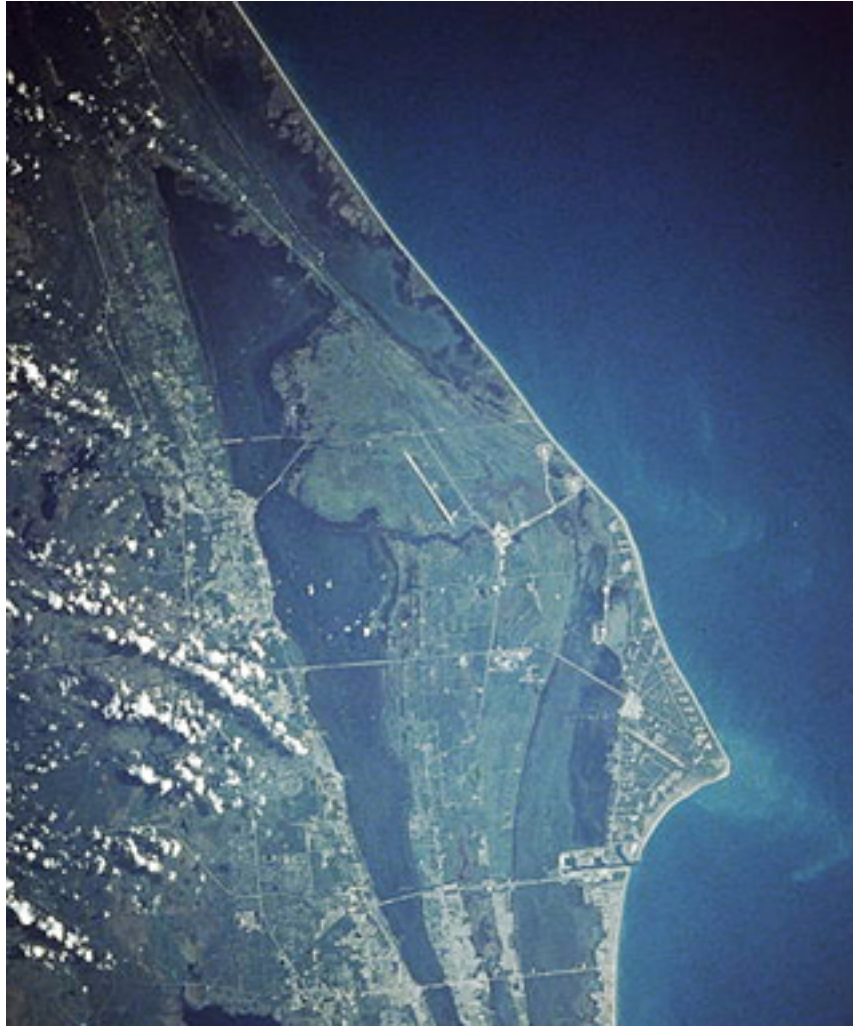
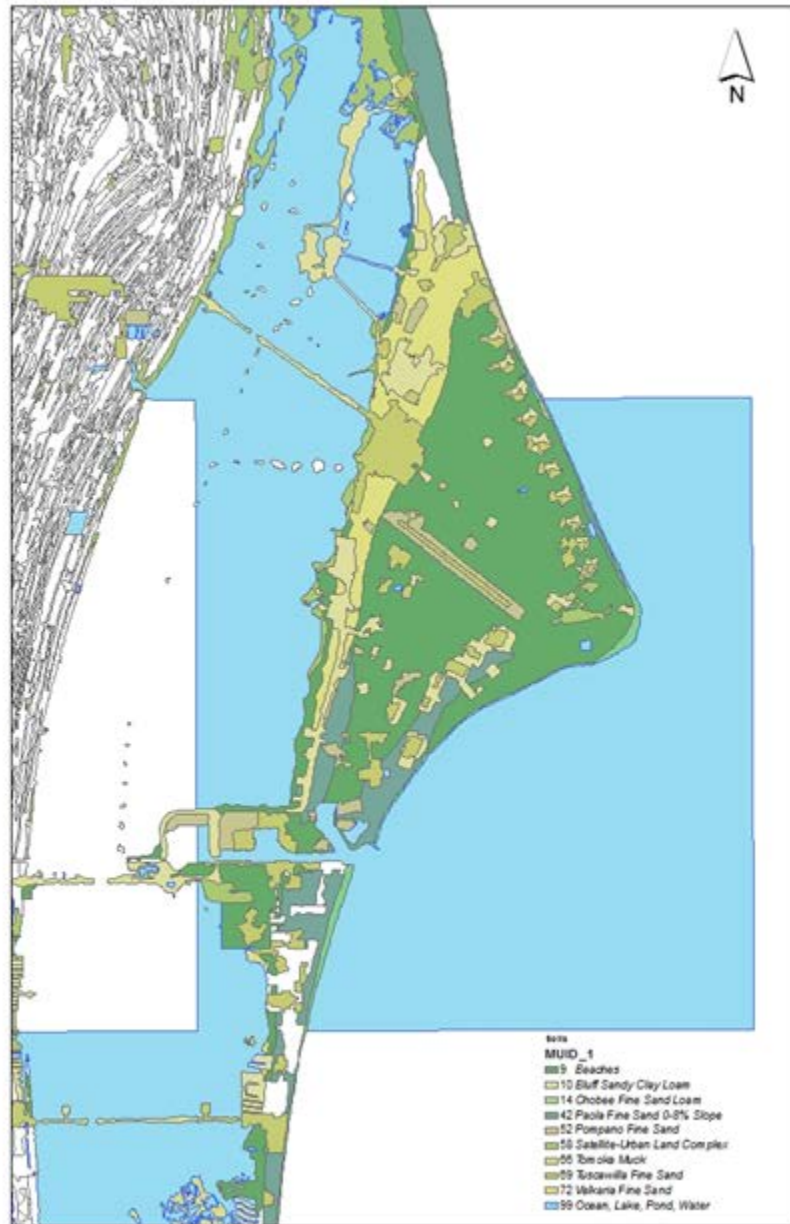

Figure 1 Cape Canaveral Satellite Image. source; www.nps.gov 2014



Source: US Soil Conservation Survey; St. Johns River Water Management District

0 0.204 0.8 1.2 1.6

Figure 2 Cape Canaveral Air Force Station Sub-surface Soil

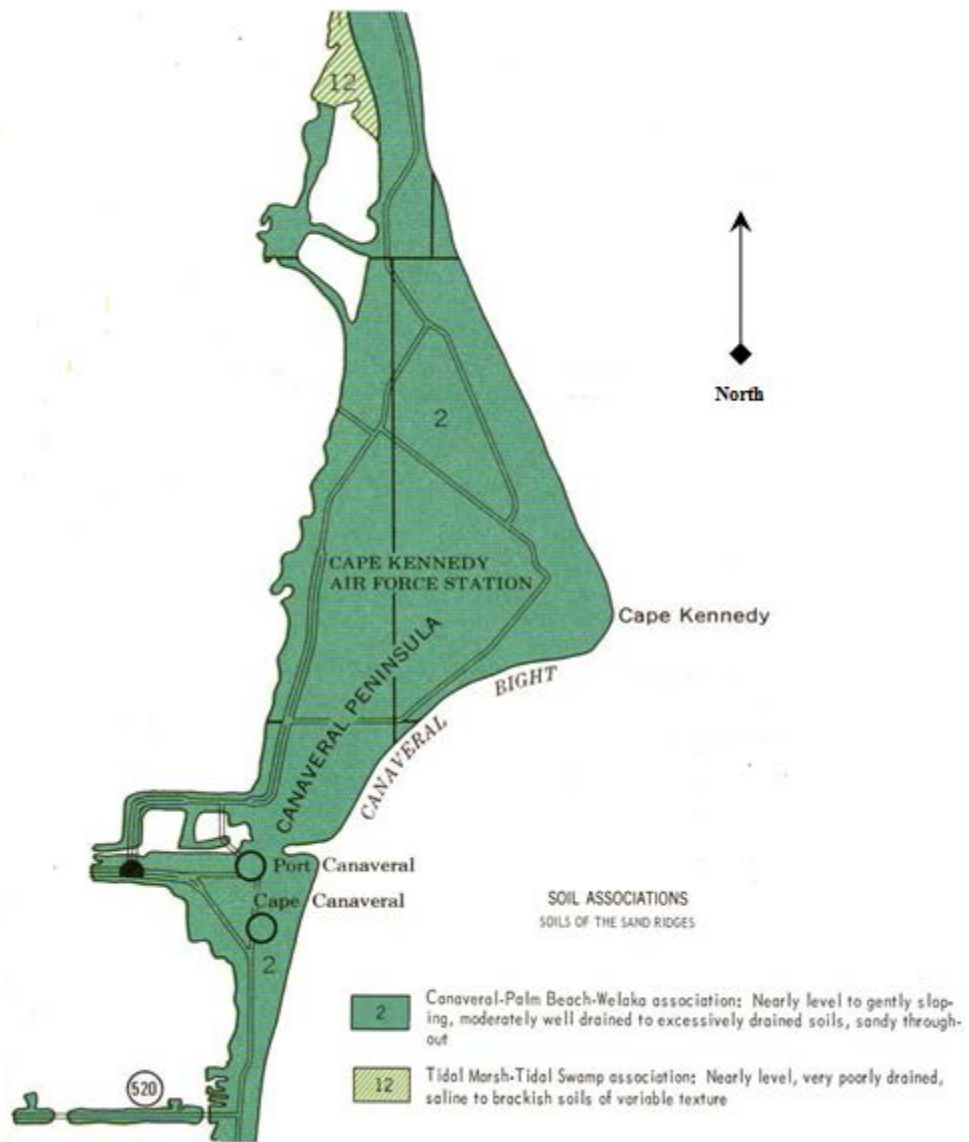

Figure 3. Soil Type USDA UFDL Map

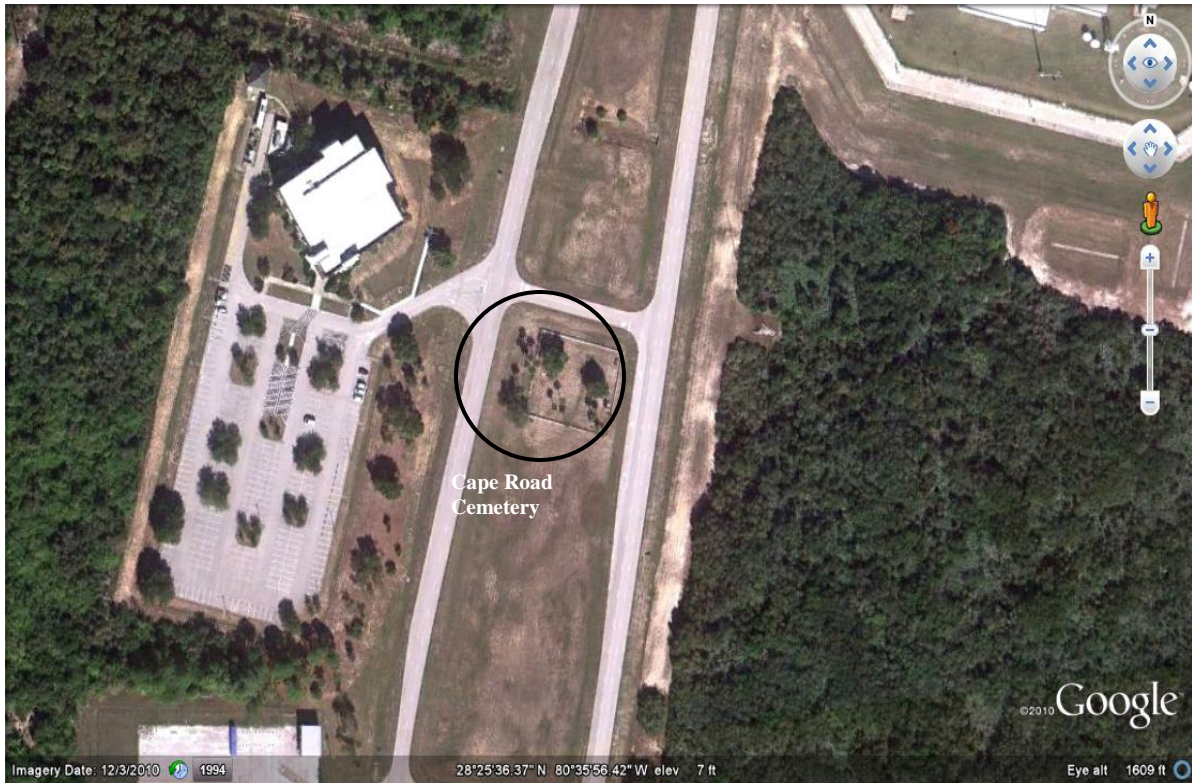

Figure 4 Cape Canaveral Cape Road Cemetery source; Google Map 2014



Figure 5 Mills O. Burnham. source; Brevard Historical Society

The screenshot displays the Legacy 8.0 software interface for a family page. At the top, there is a menu bar with options: Legacy Home | Family | Pedigree | Descendant | Chronology | Index. Below this, the main content area is divided into several sections:

- Parents:** Timothy Burnham (1782-), Catherine Young (1784-). There are buttons for 'Click to Add Father' and 'Click to Add Mother'.
- Husband:** Captain Mills Olcott Burnham. Born: 9-8-1817, Thetford, Orange County, Vermont. Sex: M. Age: 68. Buried: 4-17-1886. Buried: Burnham Cemetery (homestead).
- Wife:** Mary Ann McCune/Burnham. Born: 8-18-1821, Ulster, North Ireland. Sex: F. Age: 66. Buried: 6-25-1888. Buried: Burnham Cemetery (homestead).
- Marriage:** 9-9-1835.
- Children:** A list of seven children:
 - 1 Frances Augusta Burnham (1838-1924)+
 - 2 George Burnham (Abt 1839-1855)
 - 3 Mills Olcott Burnham Jr. (1843-1862)
 - 4 Louise Burnham §
 - 5 Mary Burnham §
 - 6 Katherine Jerusha Burnham Quarterman (1845-1927)+
 - 7 Anna Dummit Burnham (1859-1945)+
 There is a 'Click to Add a Child' button next to child 7.

The bottom of the window shows a taskbar with several open tabs, each labeled 'Right-click to set a bookmark', and a status bar with the time 8:33 and window dimensions H:1, M:1, W:2.

Figure 6 Legacy 8.0 Screen Shot of Burnham family Genealogy, source; Legacy 8

(Confederate.)

7 Fla.

Mills O Burnham Jr.
 _____, Co. _____, 7 Regiment Florida Infantry.

Appears on
Company Muster Roll
 of the organization named above,
 for *Feb 7 1862*, 186_____.

Enlisted :
 When *Feb 7 1862*, 186_____.
 Where *Fort Mifflin Pa*
 By whom *John P. ...*
 Period *2 months in the ...*

Last paid :
 By whom _____
 To what time _____, 186_____.

Present or absent _____

Remarks :
Discharged ...
Feb 1862

Book mark : _____

(642) _____ *Copyist.*

Figure 8 Muster/Death notice Mills O Burnham Jr., source; www.fold3.com

(Confederate.)

6 | 7 | Fla.

Mills O. Burnham Jr.

Co. F, 7 Reg't Florida Infantry.

Appears on

Company Muster Roll

of the organization named above,

for *Sept 11 to Nov 14*, 1862.*

Enlisted:

When *Sept 11*, 1862.

Where *Camp Lee Va*

By whom *T. J. ...*

Period *Sept 11 to Nov 14*

Last paid:

By whom *T. J. ...*

To what time *Nov 14*, 1862.

Present or absent *Absent*

Remarks:

absent sick leave

Sept 11 to 14

*Roll endorsed: "This muster was made under an 'immediate' order of Nov. 6, 1862, on Nov. 14, 1862."

Book mark:

Mills O. Burnham Jr.
Copyist

(642)

Figure 9 Muster November 1862, Mills O. Burnham Jr., source; www.fold3.com

(CONFEDERATE.)

B *7* *Fla*

M. O. Burnham.
Regt Co. D. 7 Regt Fla

Appears on a
as Mills O. Burnham left

List

of military clothing left by deceased soldiers

in Gate City Hospital,
at Atlanta, Ga.

List dated
June 6, 186

Value *\$3.00*

Remarks:

Book mark:

J. W. Wilkinson
(652) 1965 Copyist.

Figure 10 Mills O. Burnham Jr. Personal Effects, source; www.fold3.com



Figure 11 Possible Mills O. Burnham Jr. headstone, source; www.oaklandcemeteryburials.com

U.S. DEPARTMENT OF COMMERCE

MANIFEST of Slaves, Passengers on board the *Steamer S. Mathews of Savannah*

P. M. Mully - Master, burthen *175* - Tons, bound from *Savannah* for *Jacksonville*

NAMES	SEX	AGE	HEIGHT		CLASS	OWNERS OR SHIPPERS	RESIDENCE
			FEET	INCHES			
<i>Pence</i>	<i>Male</i>	<i>20</i>	<i>5</i>	<i>10</i>	<i>Black</i>	<i>J. Burnham</i>	<i>Savannah</i>
<i>Nancy Child</i>	<i>Female</i>	<i>30</i>	<i>5</i>	<i>5</i>			
<i>Daisy</i>	<i>Male</i>	<i>60</i>	<i>5</i>	<i>6</i>			
<i>Linda</i>	<i>Female</i>	<i>50</i>	<i>5</i>	<i>5</i>			
<i>Daphney</i>		<i>70</i>	<i>5</i>	<i>5</i>			
<i>John</i>	<i>Male</i>	<i>12</i>	<i>5</i>	<i>5</i>			
<i>Sally</i>	<i>Female</i>	<i>40</i>	<i>5</i>	<i>5</i>			
<i>Henry</i>	<i>Male</i>	<i>25</i>	<i>5</i>	<i>6</i>		<i>Mills O. Burnham</i>	<i>Jacksonville</i>

Figure 12 Slave Manifest related to Mills O. Burnham Sr., source; www.ancestry.com



Figure 13 Cape Road Cemetery 1943, source; Thomas E. Penders, 45 SW Cultural Resource Manager



Figure 14 Cape Road Cemetery Grid 2, source; Google Earth

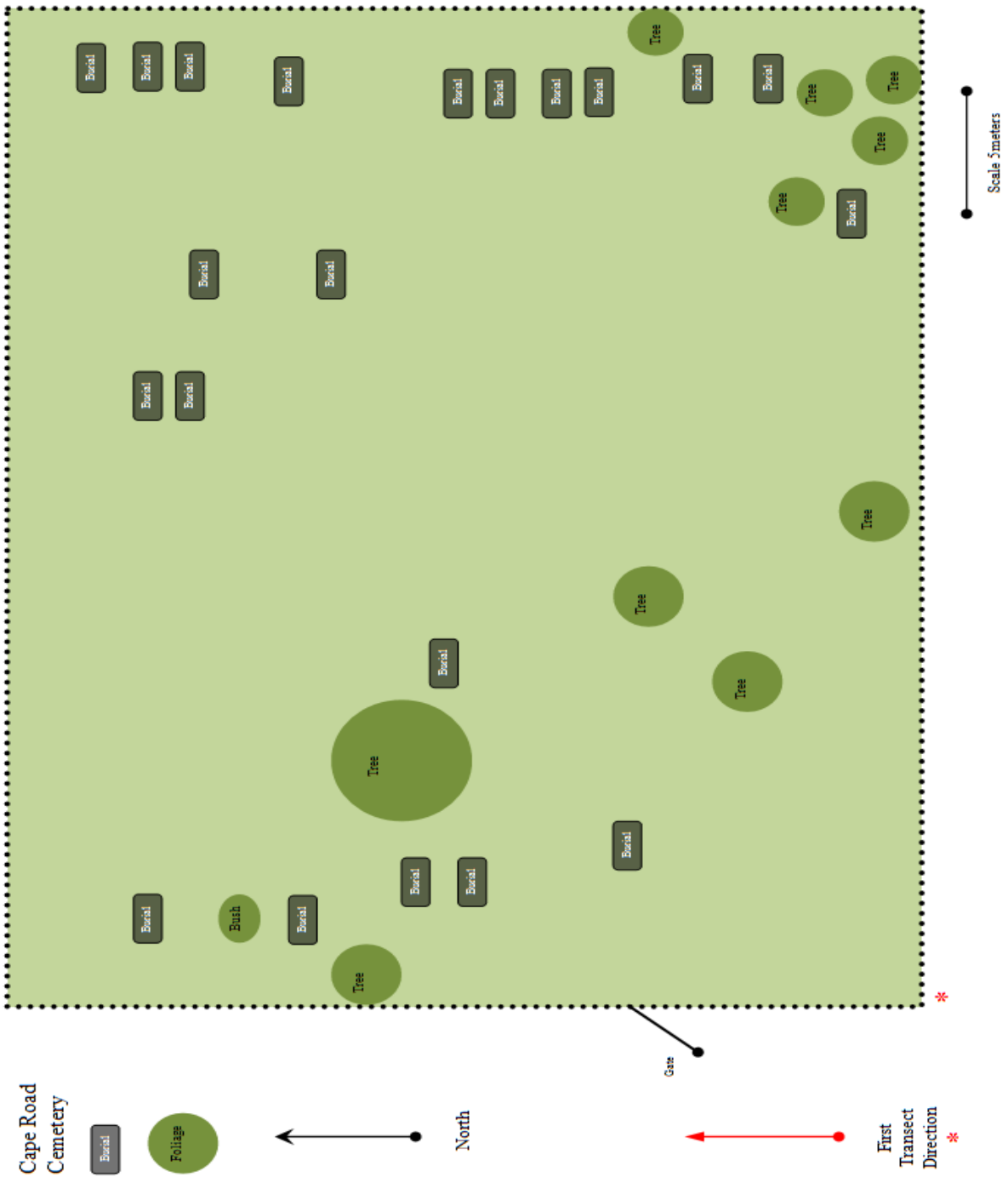

Figure 15 Cape Road Cemetery Map, source; W. Boynton

CRC Grid 2

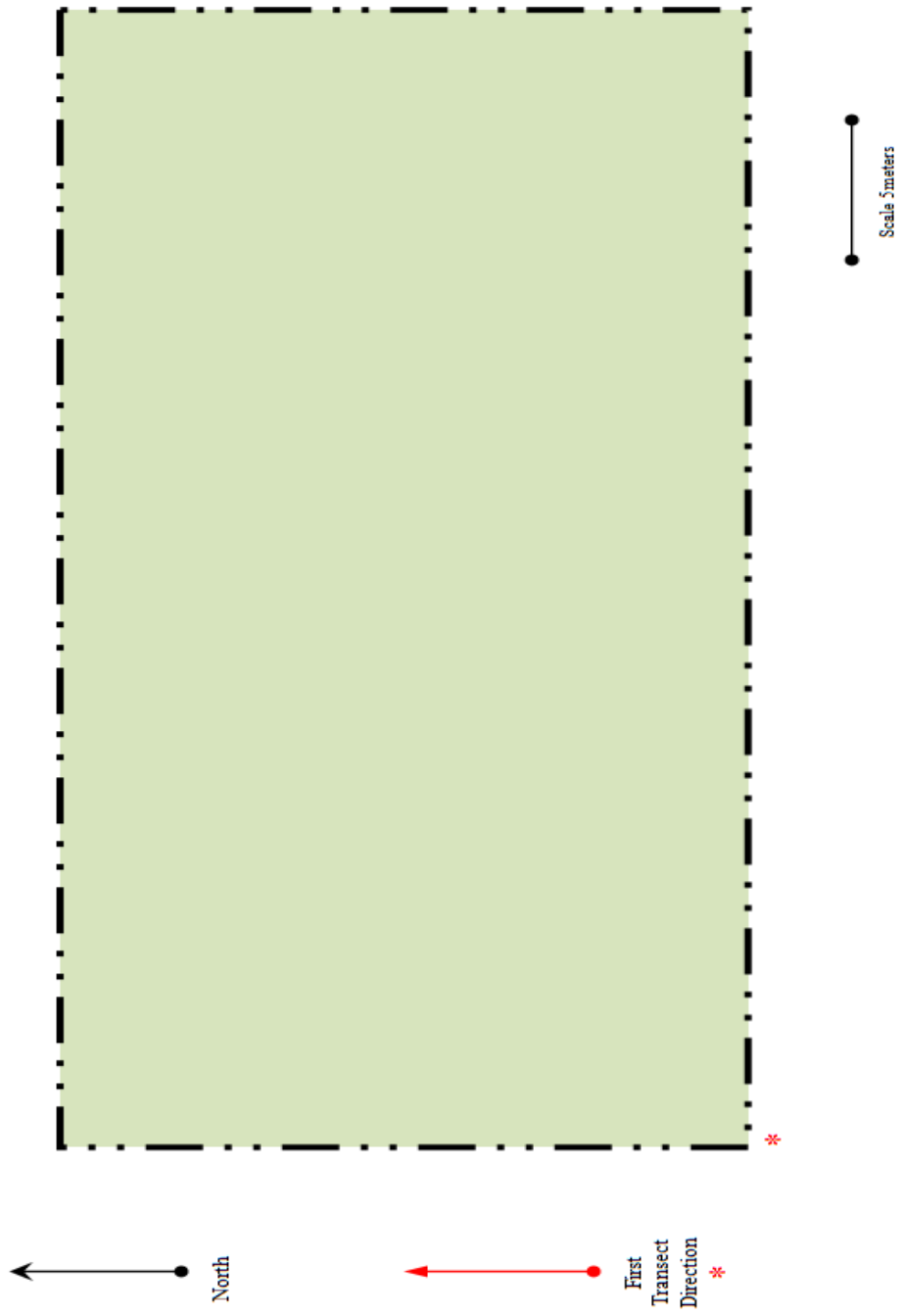

Figure 16 CRC Grid 2 Map, source: W. Boynton

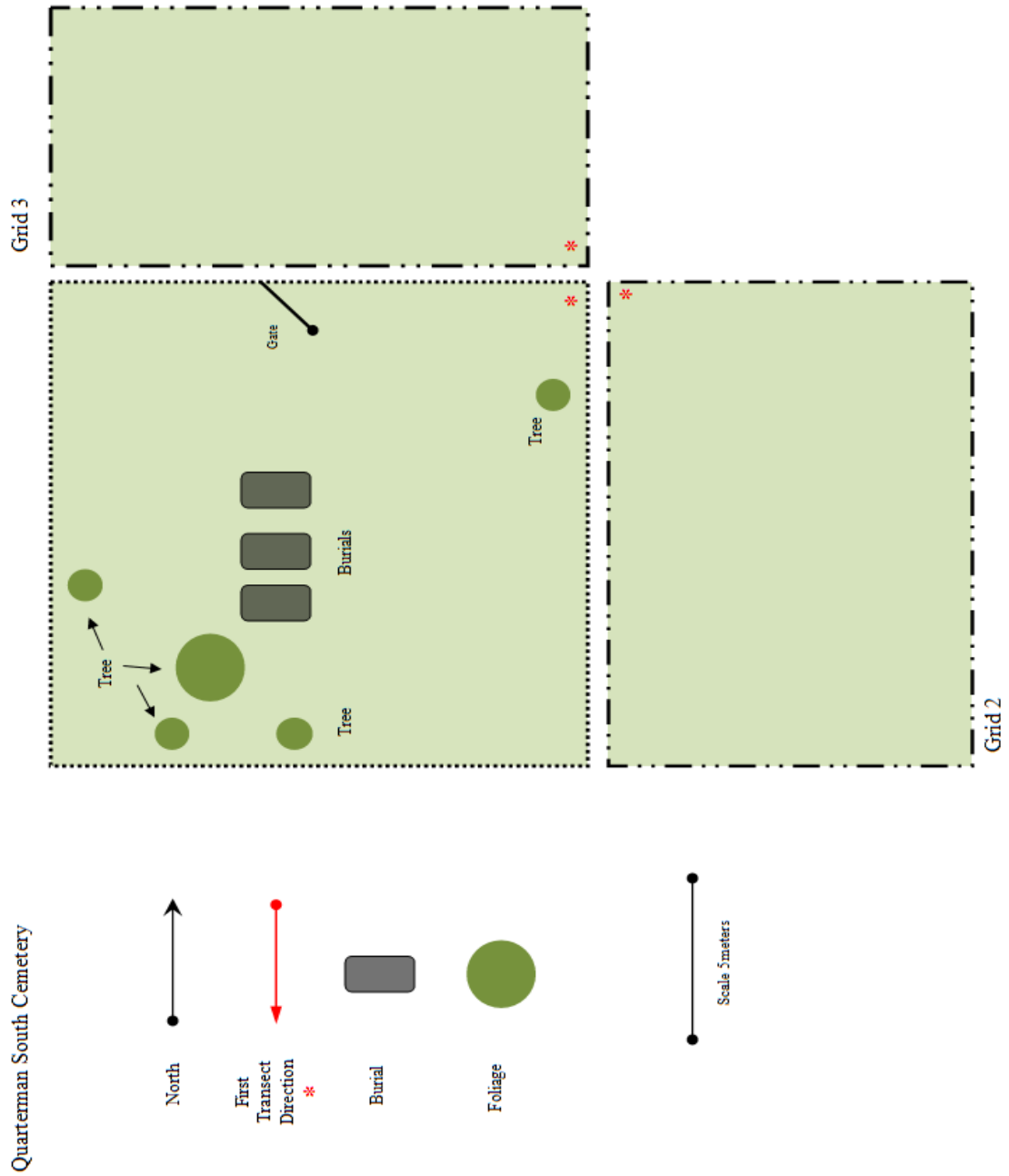

Figure 17 Quarterman South Grid Maps, source; W. Boynton



Figure 18 Quarterman South Cemetery, source; Thomas E. Penders, 45 SW Cultural Resource Manager



Figure 19 Quarterman South Cemetery, source; Thomas E. Penders, 45 SW Cultural Resource Manager



Figure 20 Quarterman South Cemetery headstones, source; Thomas E. Pender, 45 SW Cultural Resource Manager



Figure 21 Quarterman South Cemetery Grid 2, source; Thomas E. Pender, 45 SW Cultural Resource Manager



Figure 22 Quarterman South Cemetery Grid 3, source; Thomas E. Penders 45 SW Cultural Resource Manager



Figure 23 Quarterman North Cemetery, source; Thomas E. Penders 45 SW Cultural Resource Manager



Figure 24 Quarterman North Grid Maps, source; W. Boynton



Figure 25 Burnham Family Cemetery, source; Thomas E. Penders, 45 SW Cultural Resource Manager

Burnham Family Cemetery

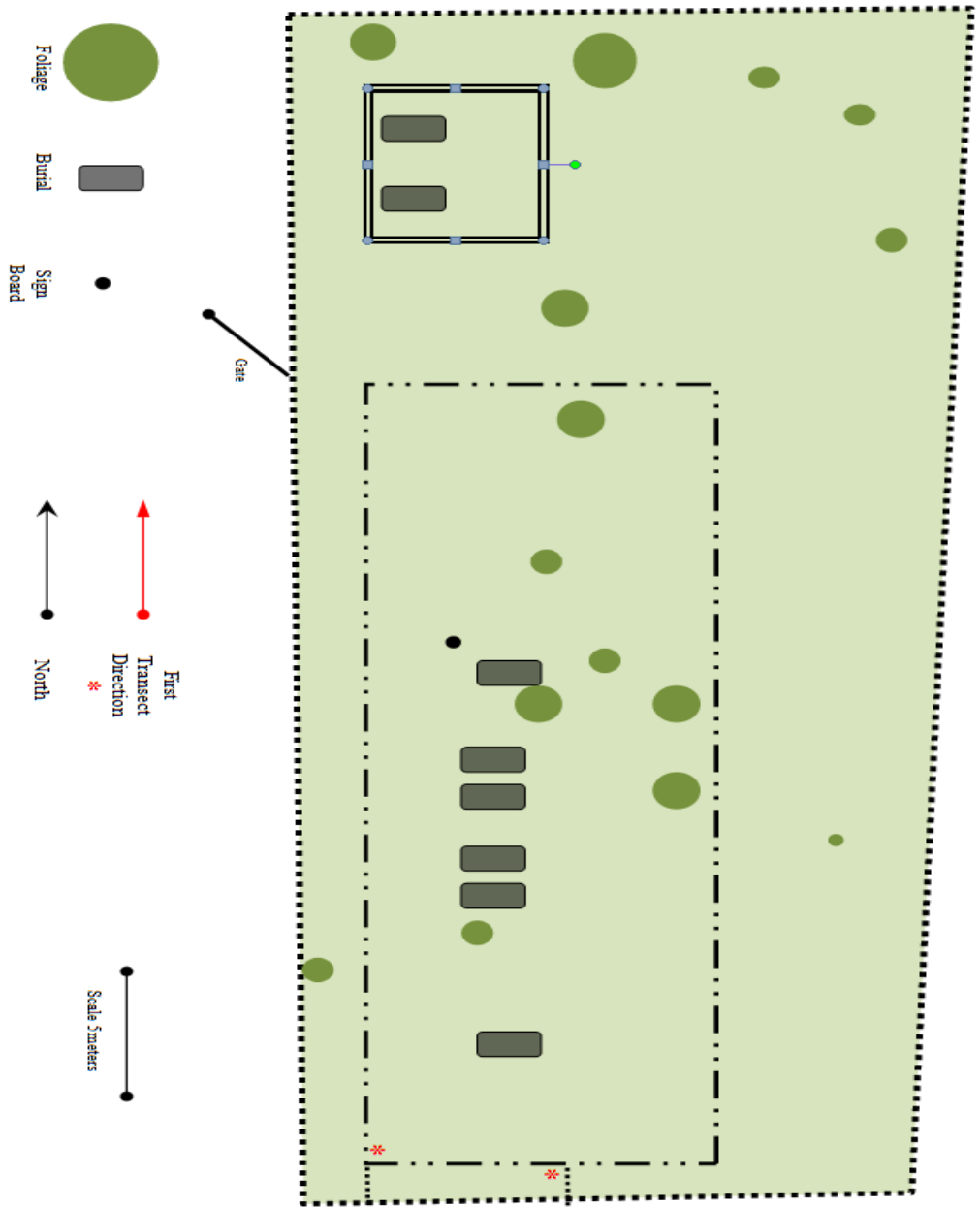

Figure 26 Burnham Family Cemetery Map, source; W. Boynton



Figure 27 Burnham Cemetery North enclosure, source; Thomas Penders, 45 SW Cultural Resource Manager



Figure 28 Burnham Cemetery North perspective, source; Thomas E. Penders, 45 SW Cultural Resource Manager



Figure 29 Burnham Cemetery Southwest corner, source; Thomas E. Penders, 45 SW Cultural Resource Manager

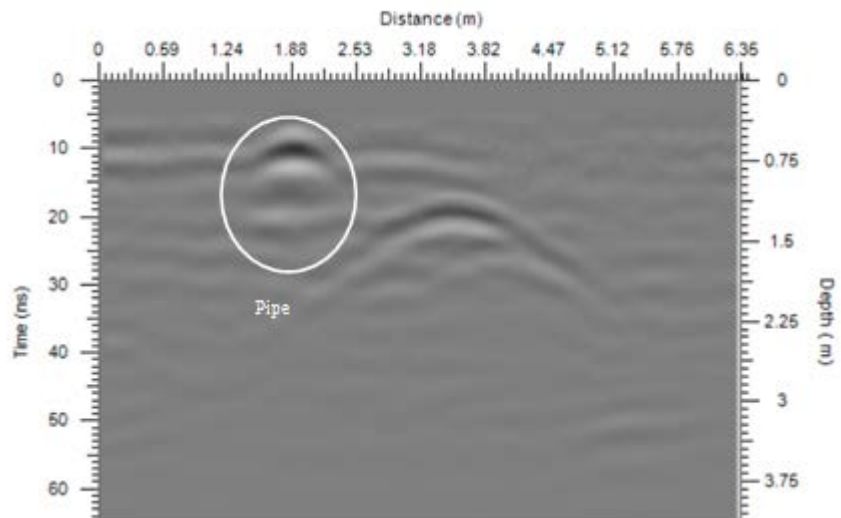

Figure 30 Calibration Pipe Cape Road Cemetery, source; GPRSoft® Pro Version 2.6.4

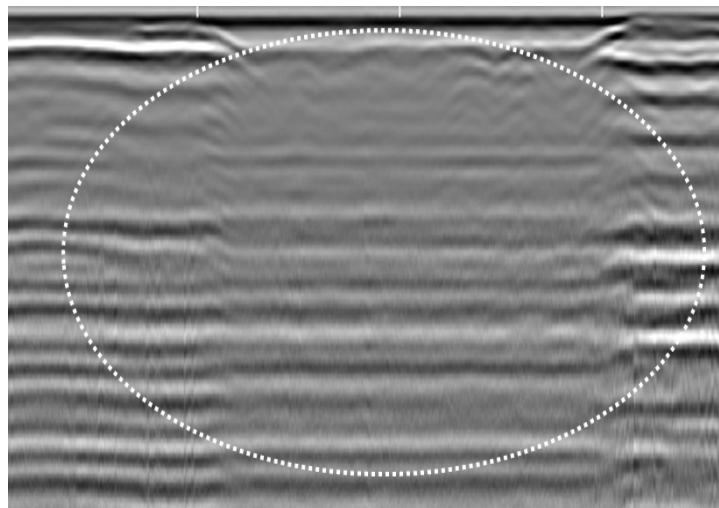

Figure 31 Tank Void, source; <http://www.enviophysics.com/GPR.html>

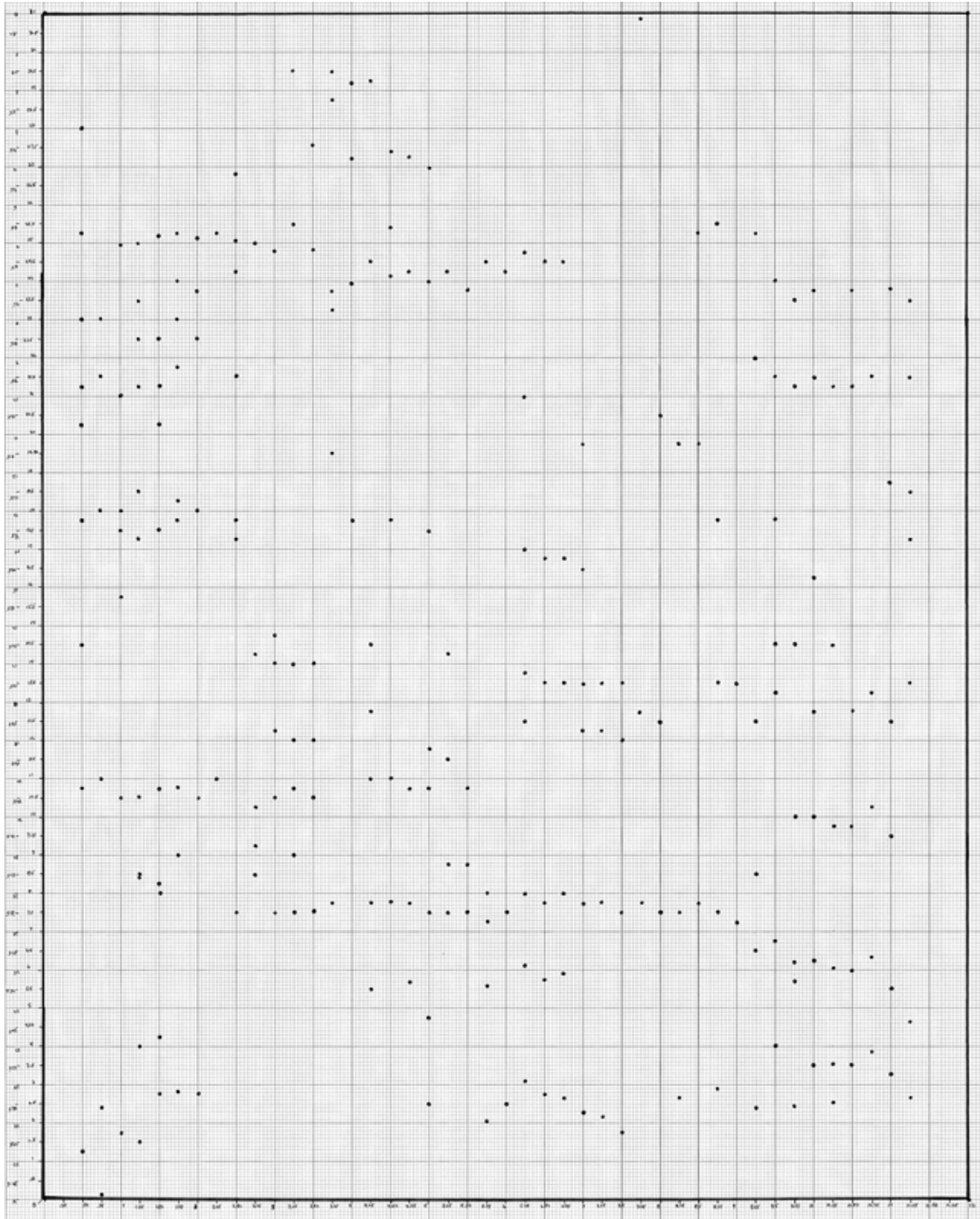

Figure 32 Example Point Plot Map Burnham Family Cemetery, source; W Boynton

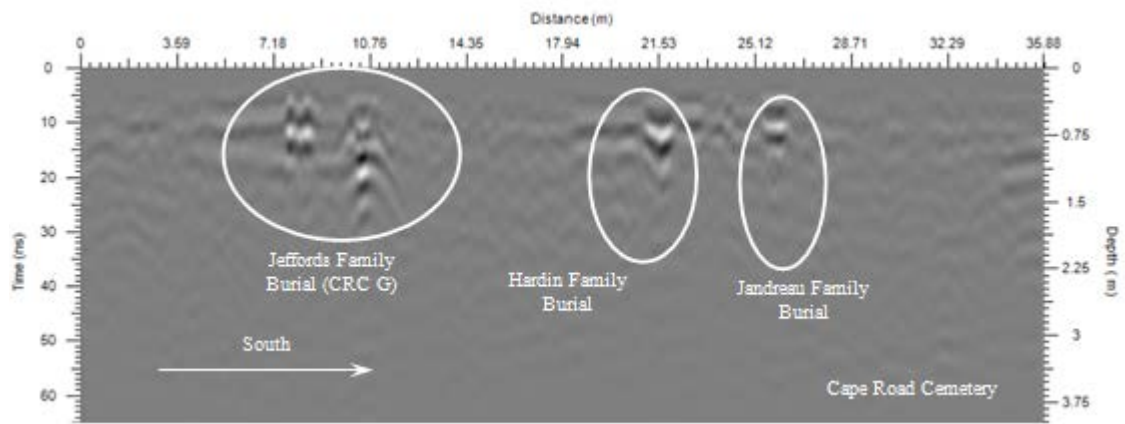

Figure 33 Cape Road Cemetery, Day 2, Transect 71, source; GPRSoft® Pro Version 2.6.4

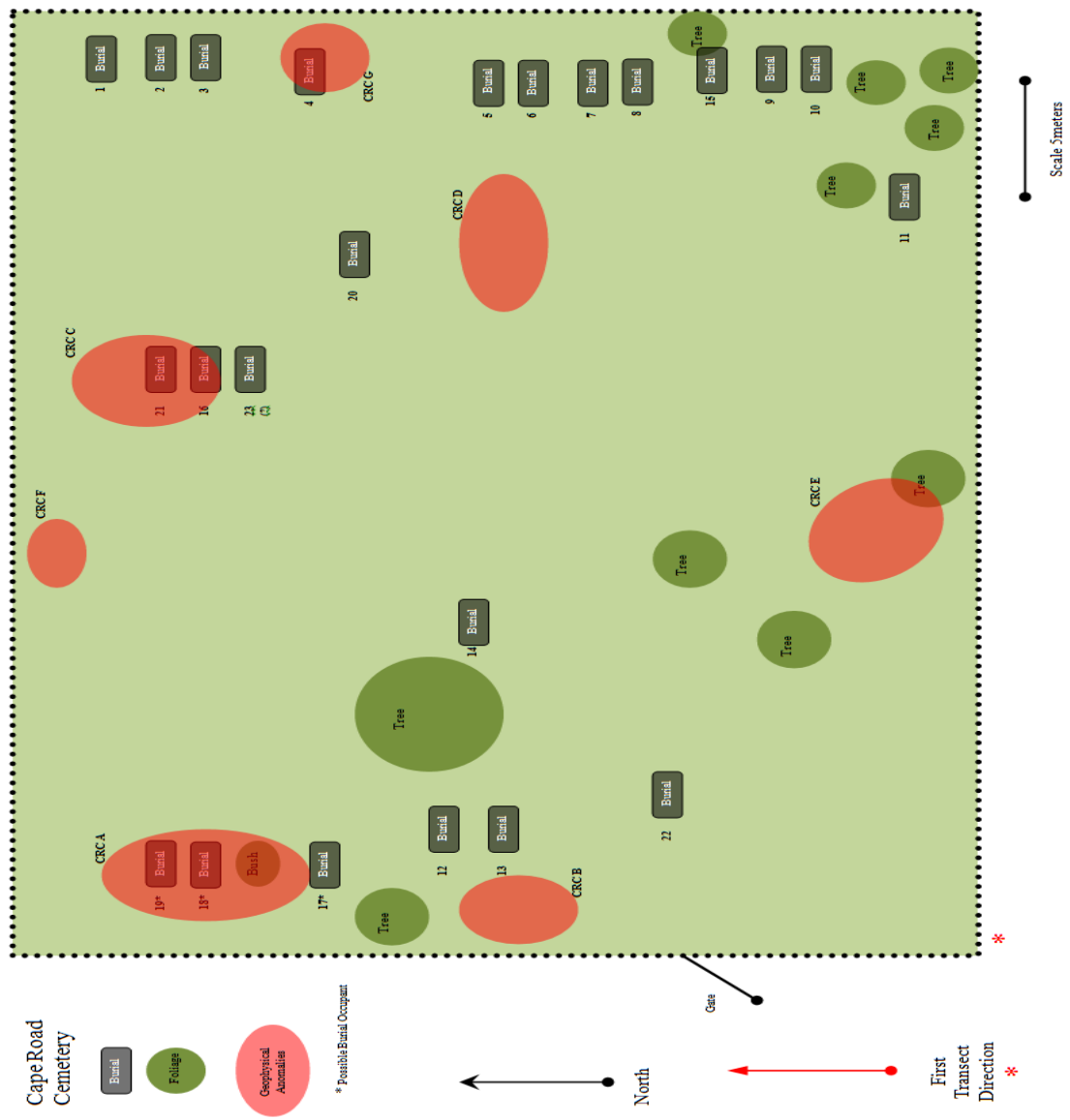

Figure 34 CRC Anomalous Features Map, source; W. Boynton

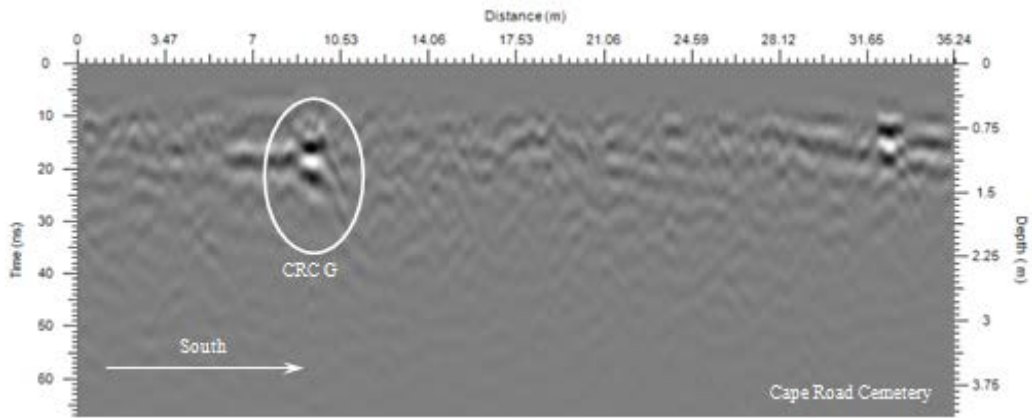

Figure 35 Cape Road Cemetery, Day 2, Transect 68, source; GPRSoft® Pro Version 2.6.4

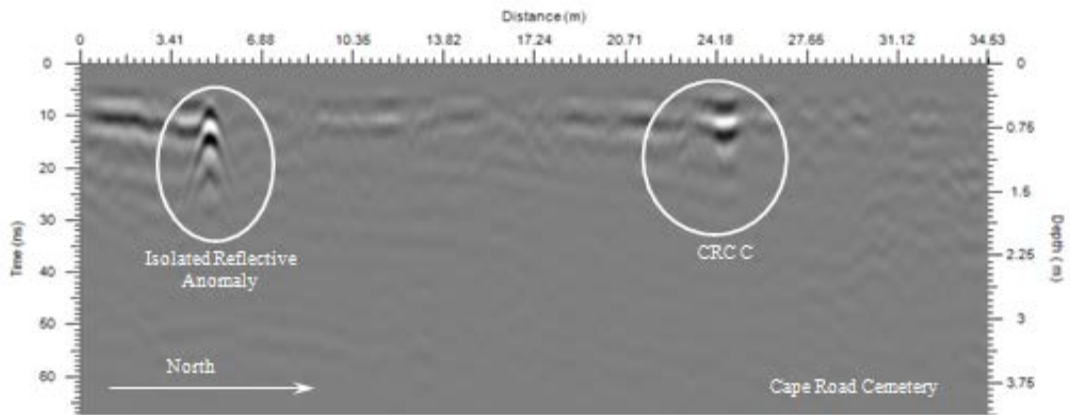

Figure 36 Cape Road Cemetery, Day 2, Transect 39, source; GPRSoft® Pro Version 2.6.4

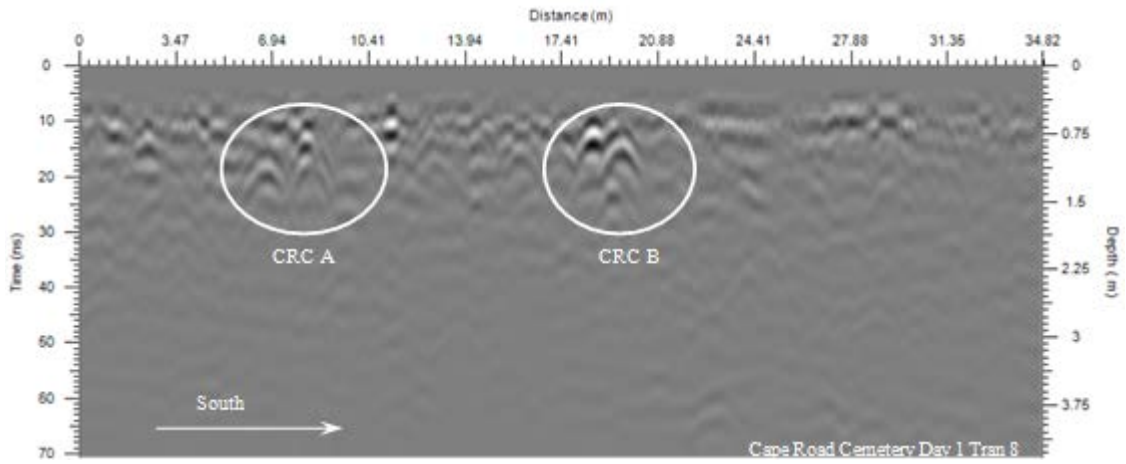

Figure 37 Cape Road Cemetery Transect 8 Day 1, source; GPRSoft® Pro Version 2.6.4

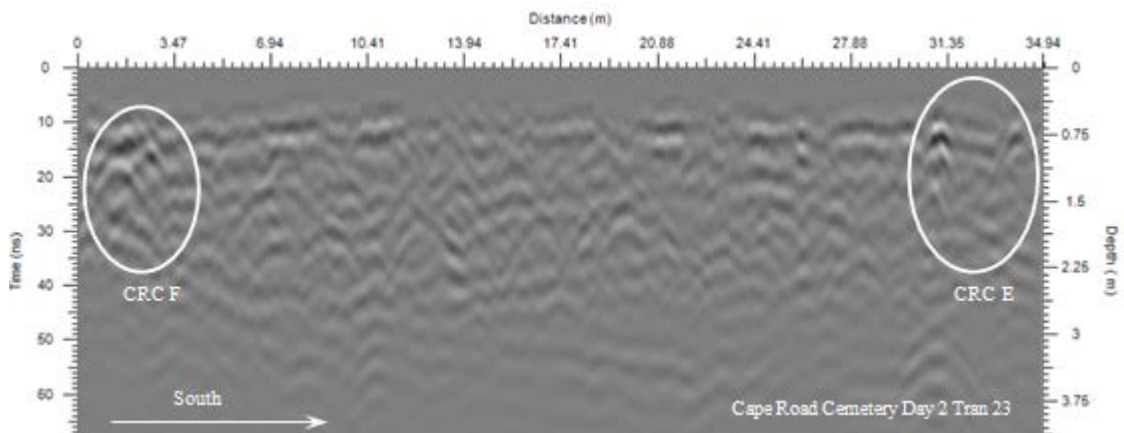

Figure 38 Cape Road Cemetery, Day 2, Transect 23, source; GPRSoft® Pro Version 2.6.4

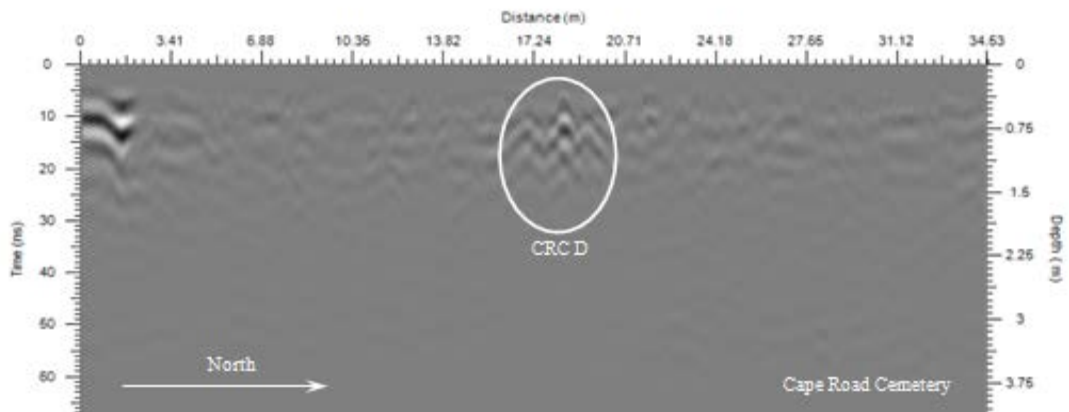

Figure 39 Cape Road Cemetery, Day 2, Transect 57, source; GPRSoft® Pro Version 2.6.4

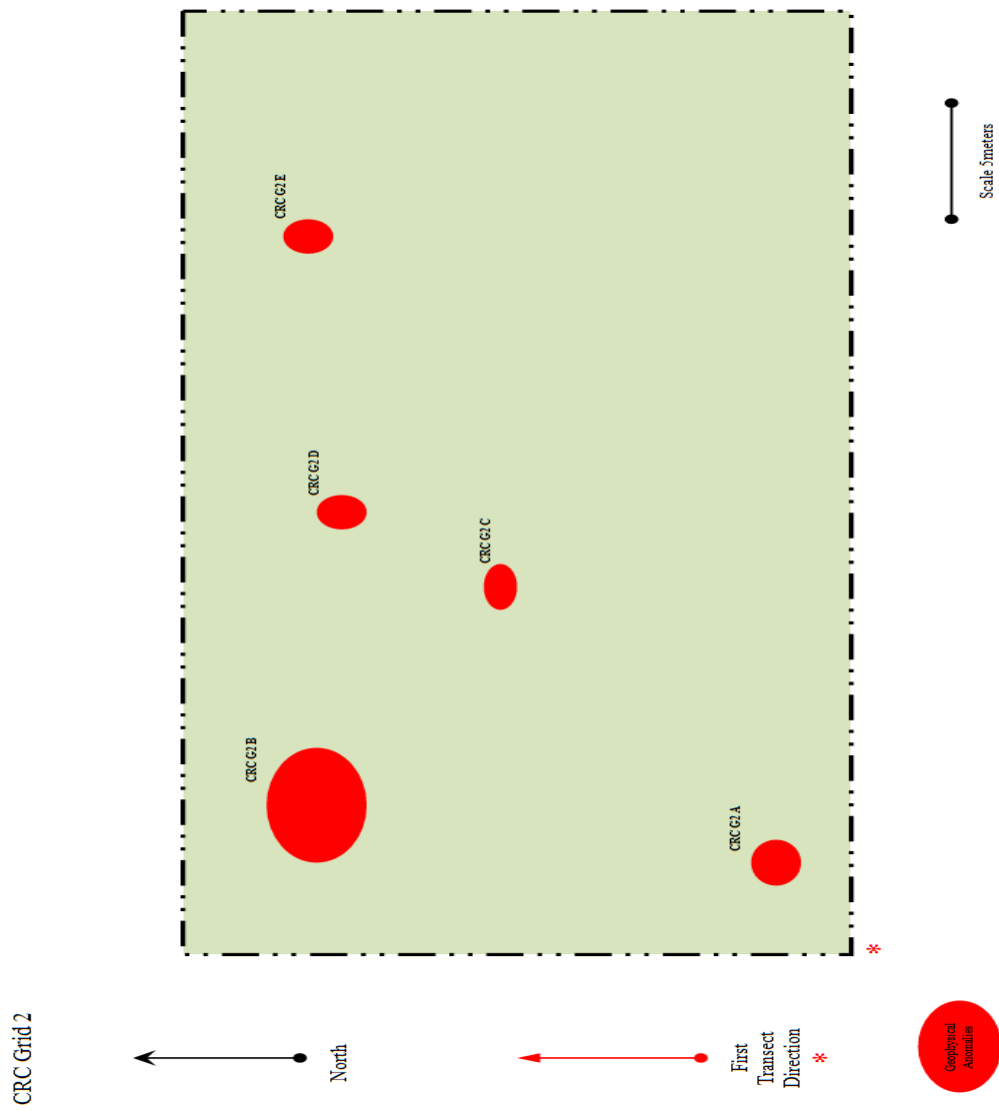

Figure 40 Cape Road Cemetery Grid 2 Anomaly Map, source; W. Boynton

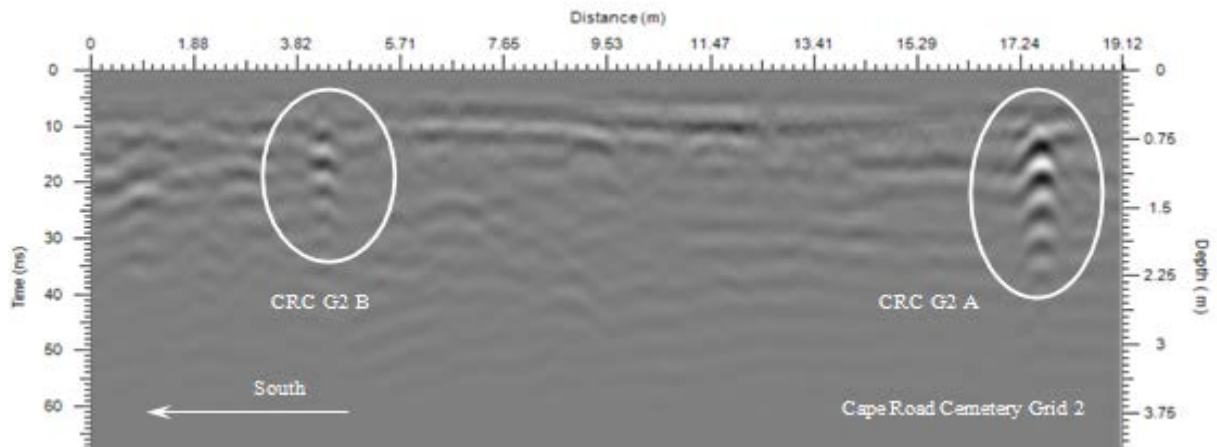

Figure 41 Cape Road Cemetery Grid 2 Transect 21, source; GPRSoft® Pro Version 2.6.4

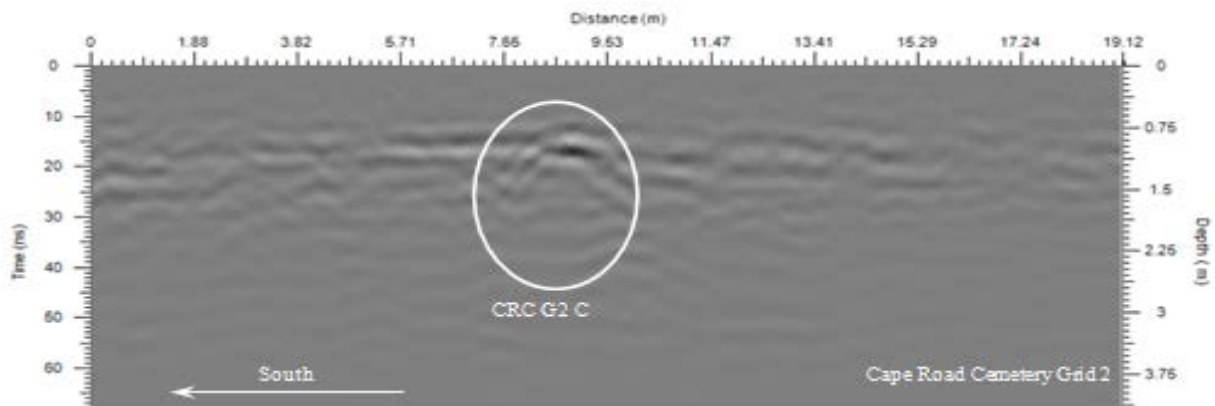

Figure 42 Cape Road Cemetery Grid 2 Transect 54, source; GPRSoft® Pro Version 2.6.4

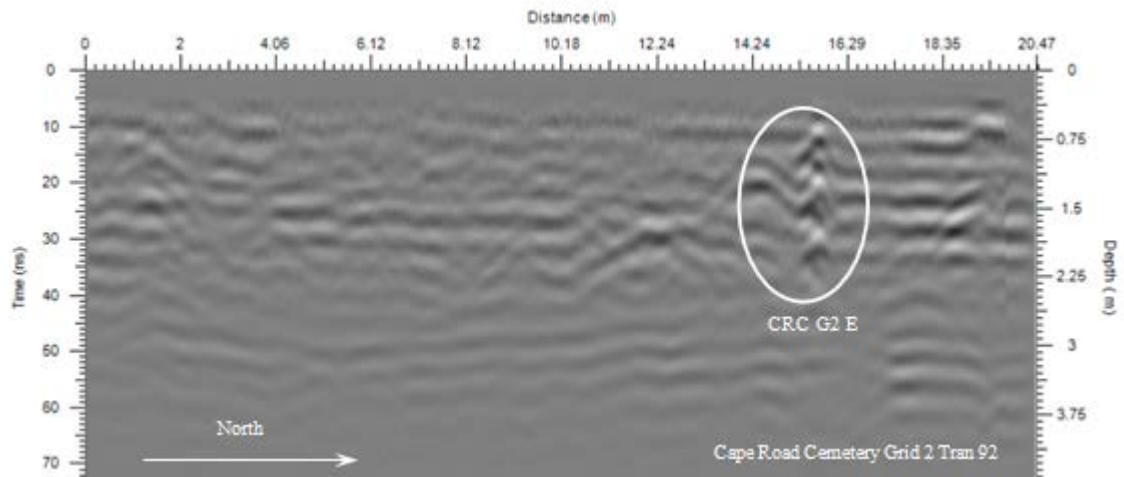

Figure 43 Cape Road Cemetery Grid 2 Transect 92, source; GPRSoft® Pro Version 2.6.4

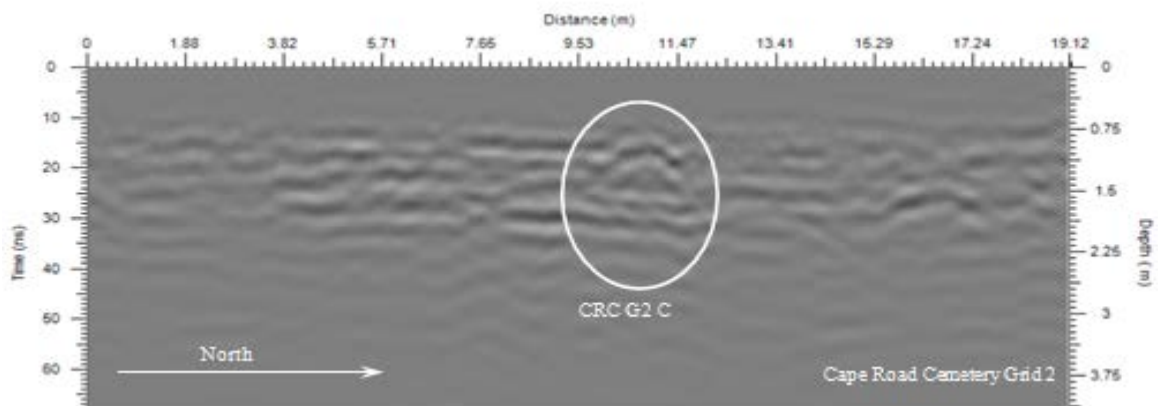

Figure 44 CRC G2 C transect 53, source; GPRSoft® Pro Version 2.6.4

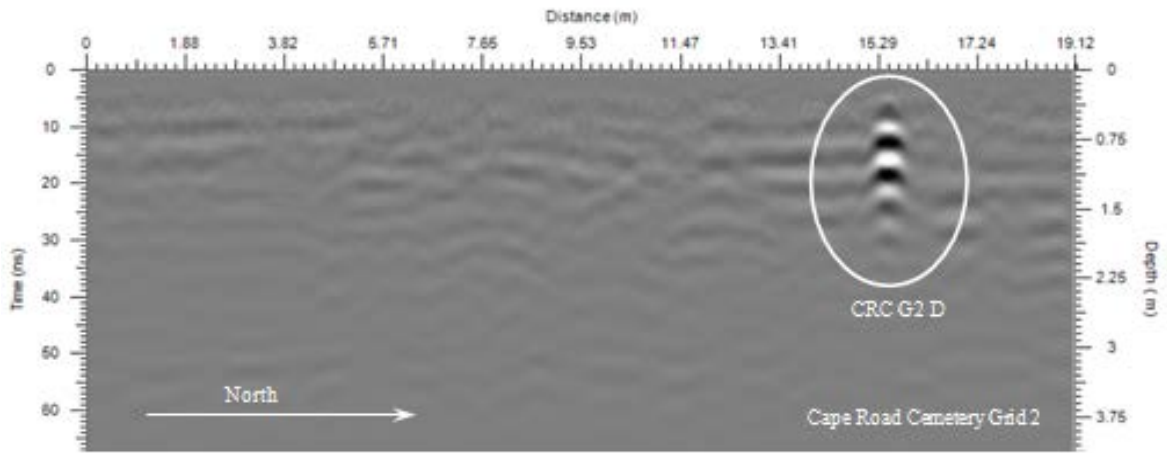

Figure 45 CRC G2 D transect 59, source; GPRSoft® Pro Version 2.6.4

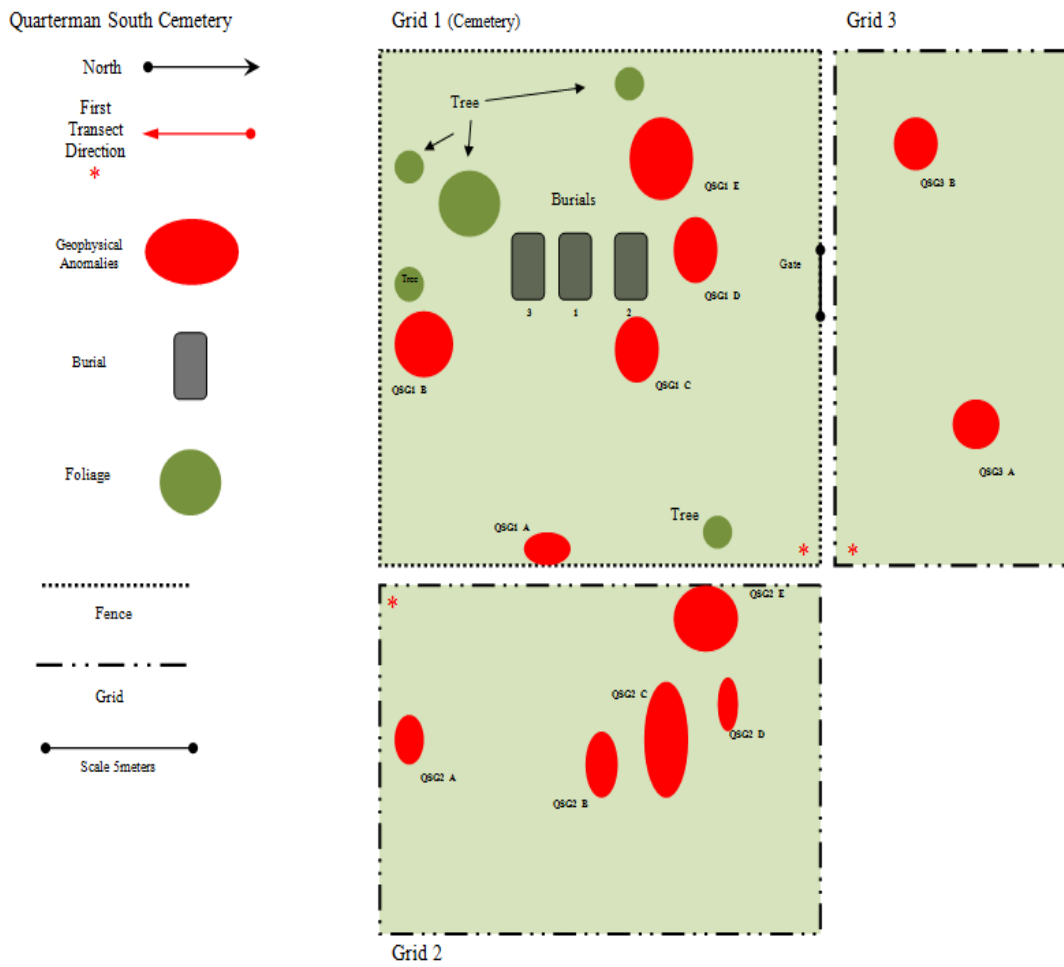

Figure 46 Quarterman South Grids 1, 2 and 3 Anomalous Maps, source; W. Boynton

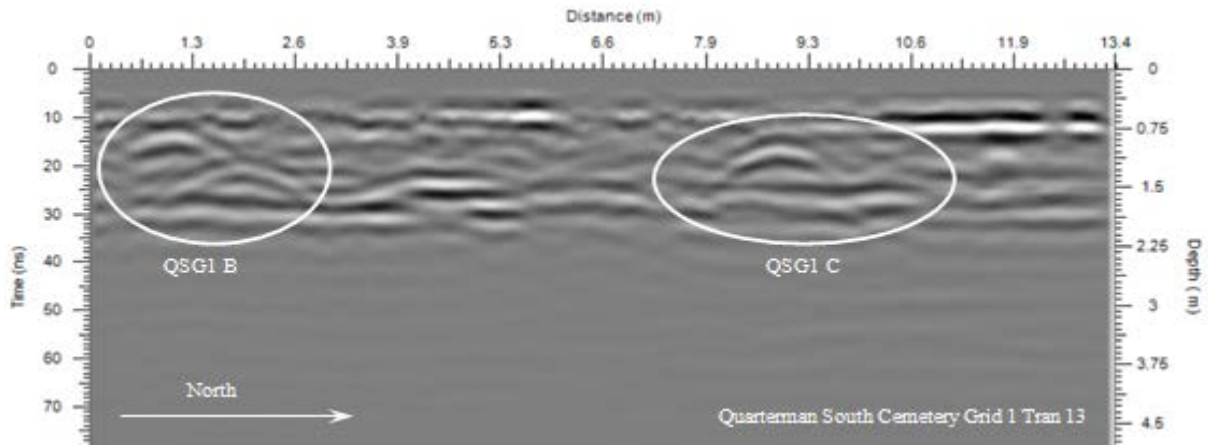

Figure 47 Quarterman South Grid 1, Transect 13, source; GPRSoft® Pro Version 2.6.4

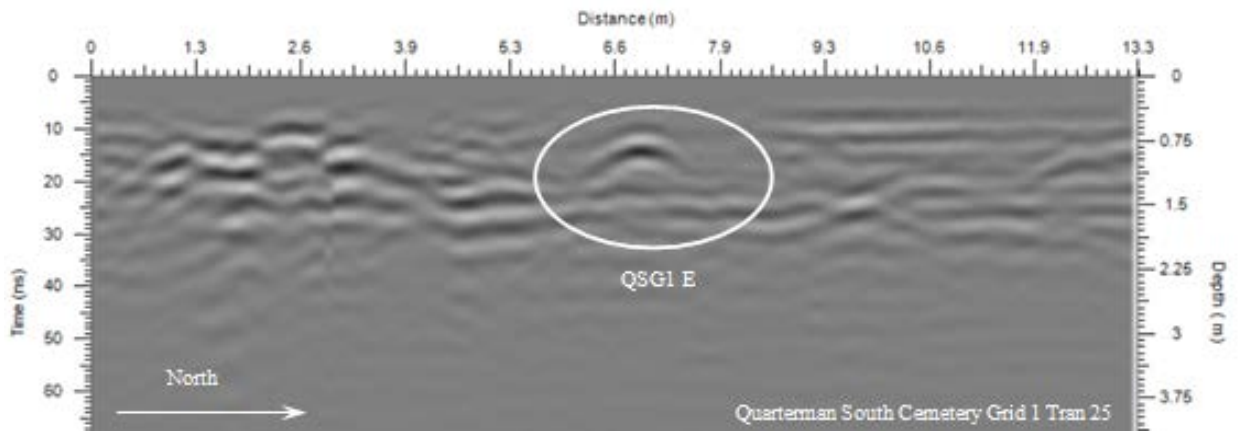

Figure 48 Quarterman South Grid 1, Transect 25, source: GPRSoft

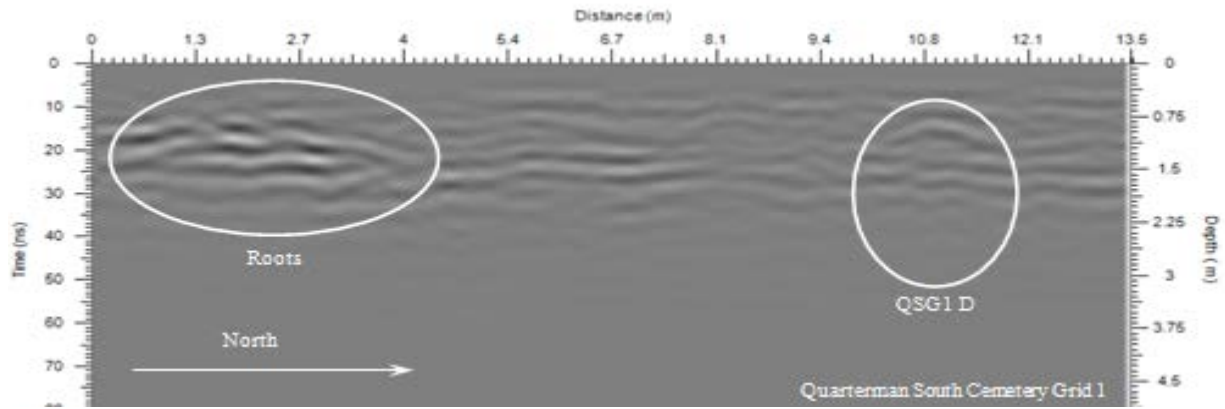

Figure 49 Quarterman South Grid 1 Transect 21, source; GPRSoft® Pro Version 2.6.4

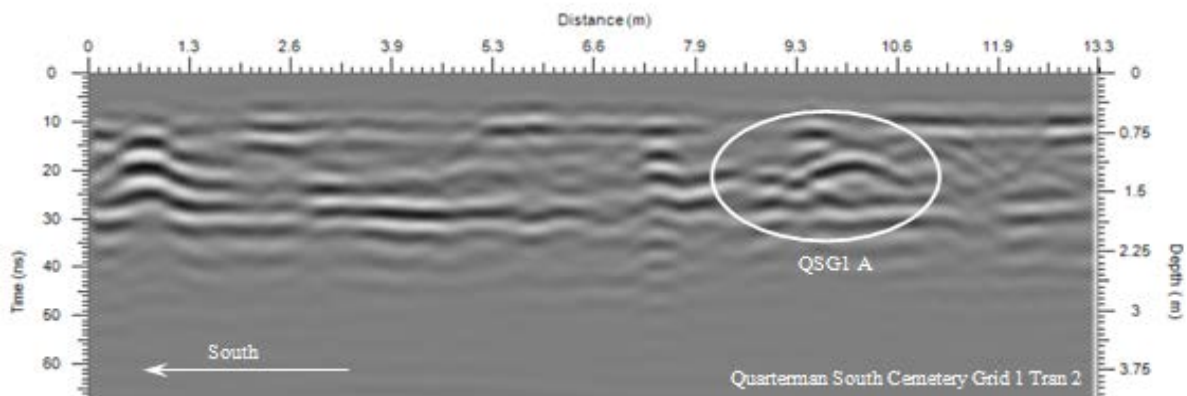

Figure 50 Quarterman South Grid 1, Transect 2, source GPRSoft® Pro Version 2.6.4

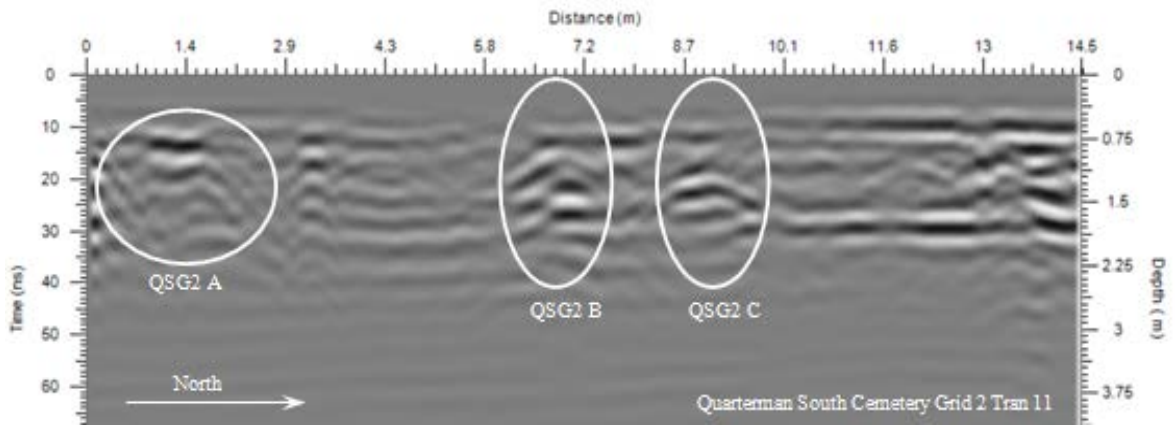

Figure 51 Quarterman South Grid 2, Transect 11, source; GPRSoft® Pro Version 2.6.4

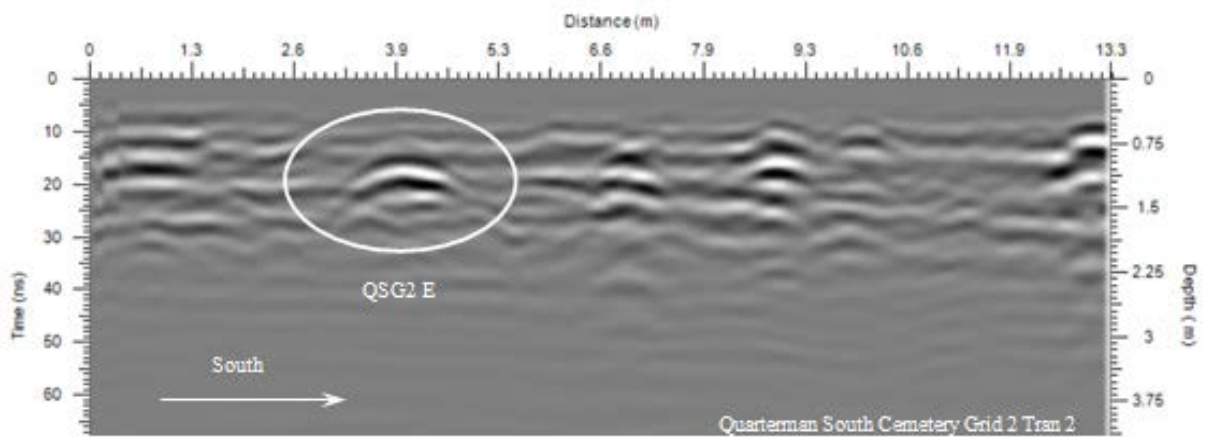

Figure 52 Quarterman South, Grid 2, Transect 2, source; GPRSoft® Pro Version 2.6.4

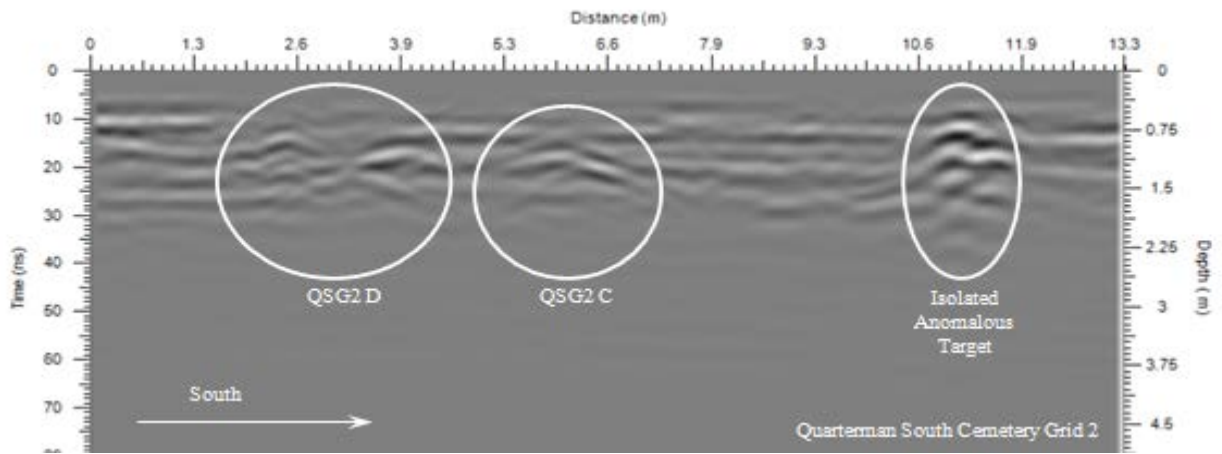

Figure 53 Quarterman South Grid 2, Transect 8, source; GPRSoft® Pro Version 2.6.4

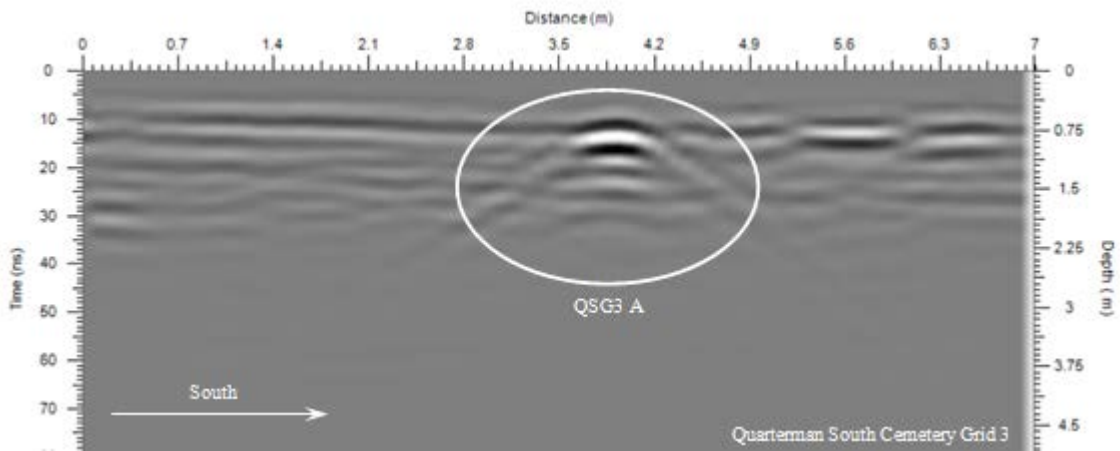

Figure 54 Quarterman South Grid 3, transect 29, source; GPRSoft® Pro Version 2.6.4

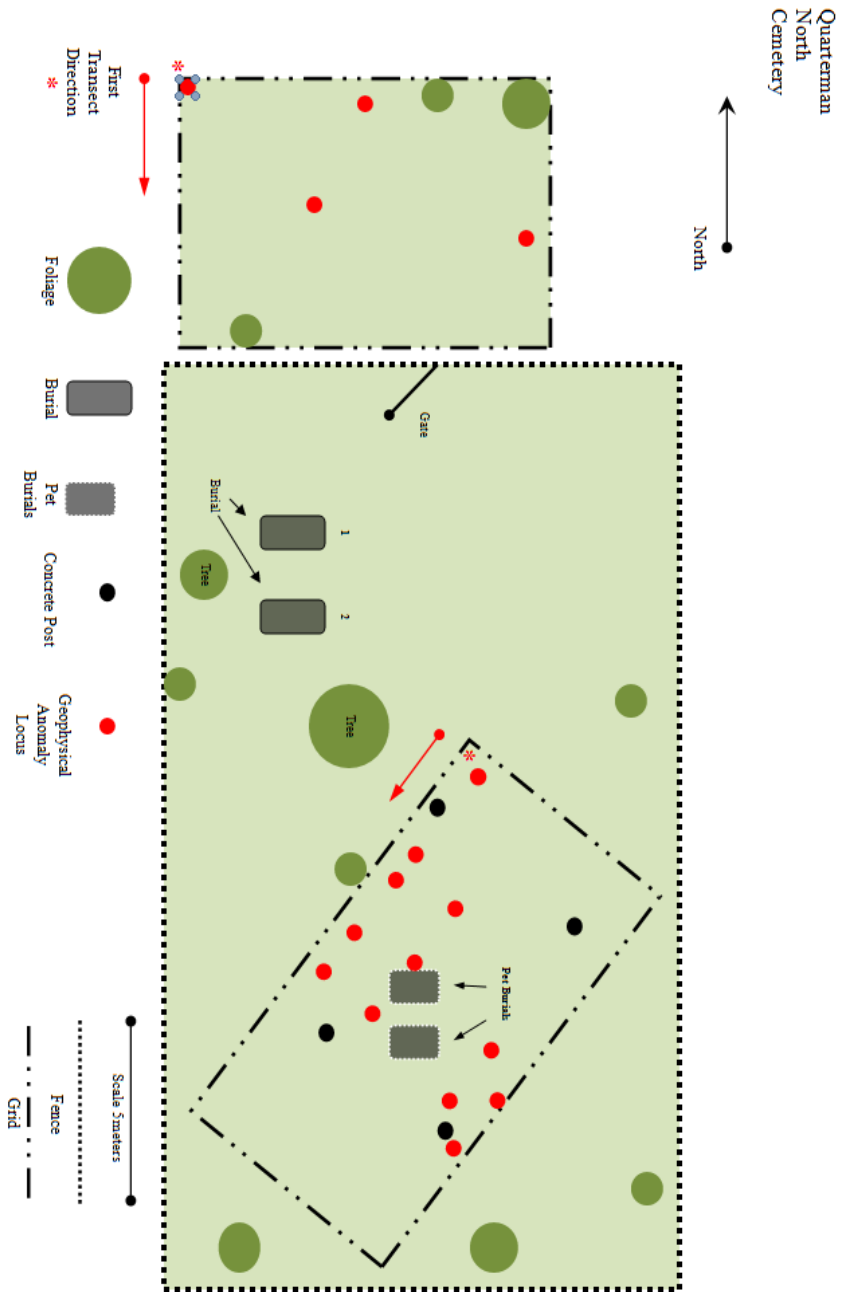

Figure 55 Quarterman North Grid 1 and 2 Anomaly Maps, source W. Boynton

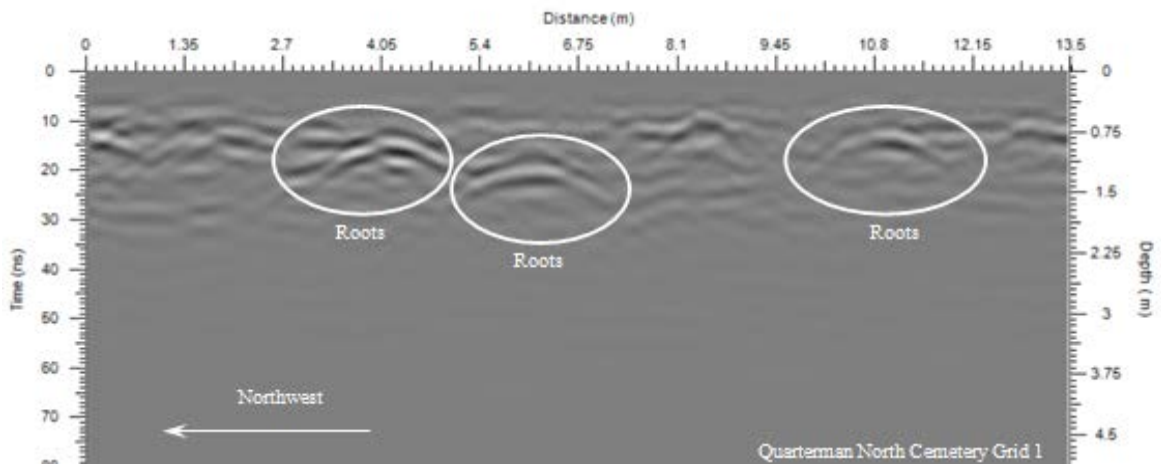

Figure 56 Quarterman North Grid 1 Transect 7, source; GPRSoft® Pro Version 2.6.4

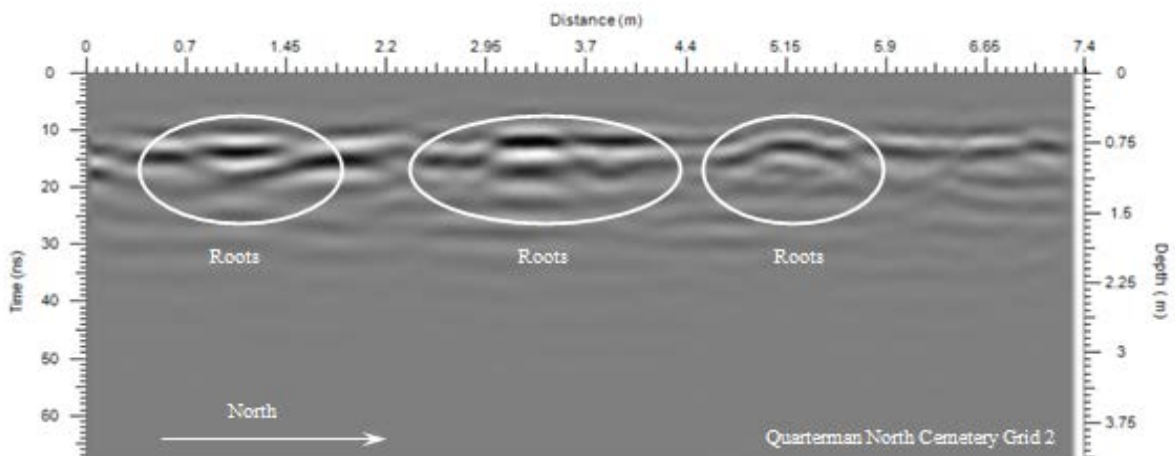

Figure 57 Quarterman North Grid 2, transect 10, source; GPRSoft® Pro Version 2.6.4

Burnham Family Cemetery

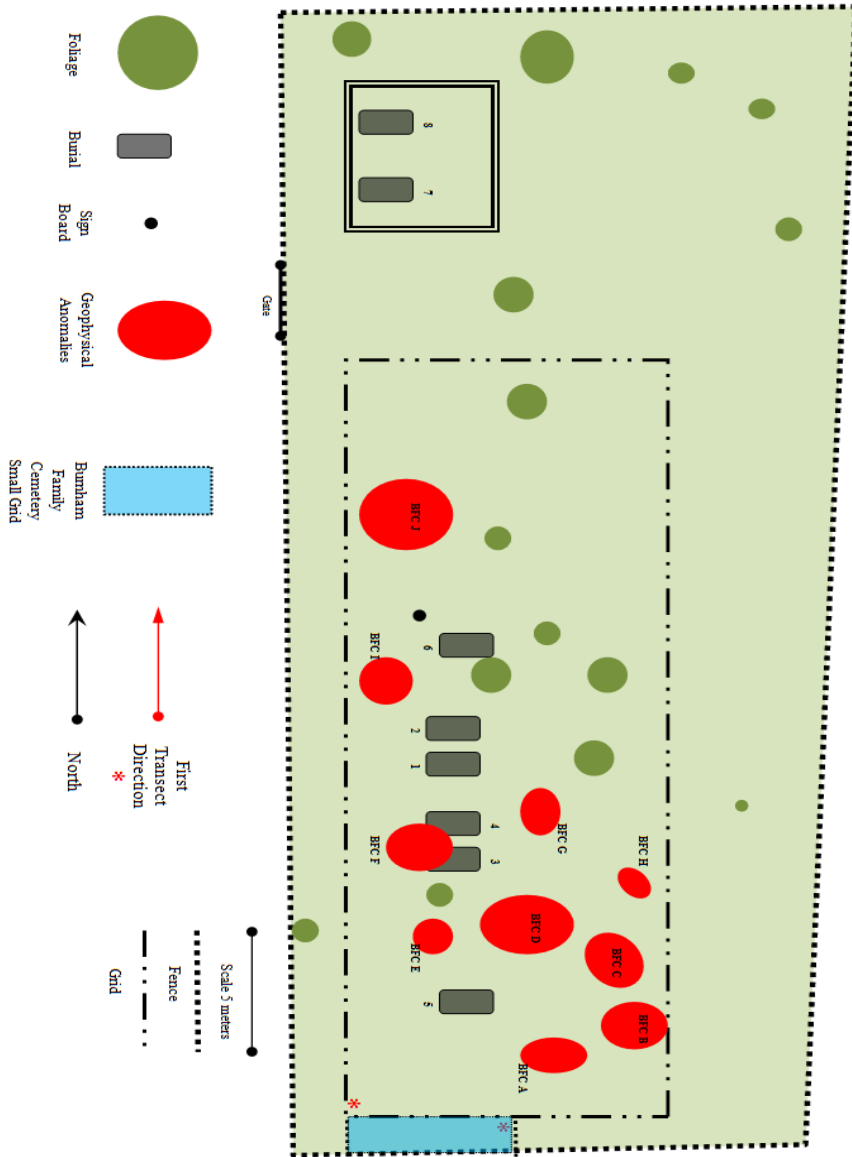

Figure 58 Burnham Family Cemetery Anomaly Map, W. Boynton



Figure 59 M. O. Burnham Burial Site, source; Thomas E. Pender 45 SW Cultural Resource Manager

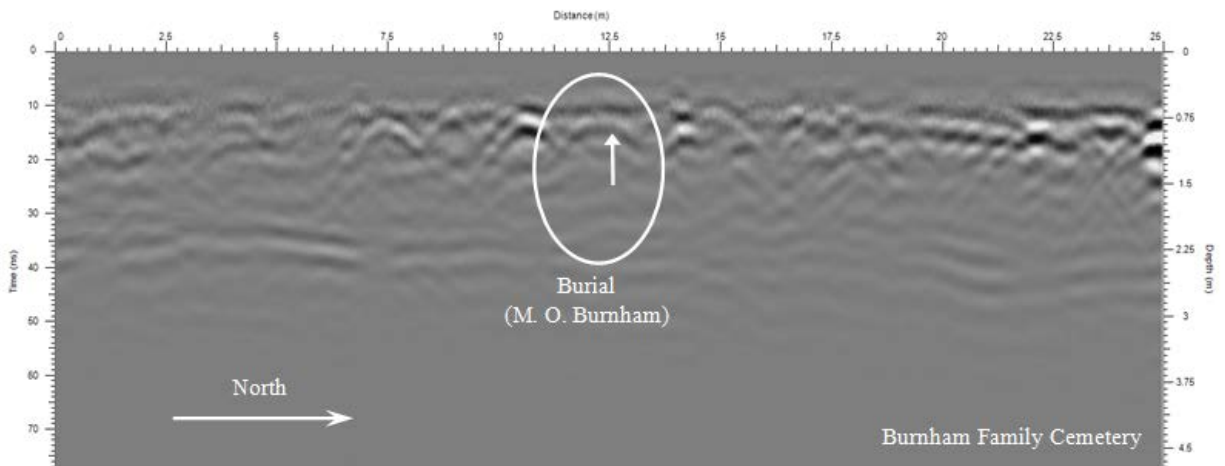

Figure 60 Burnham Family Cemetery, transect 11, source; GPRSoft® Pro Version 2.6.4

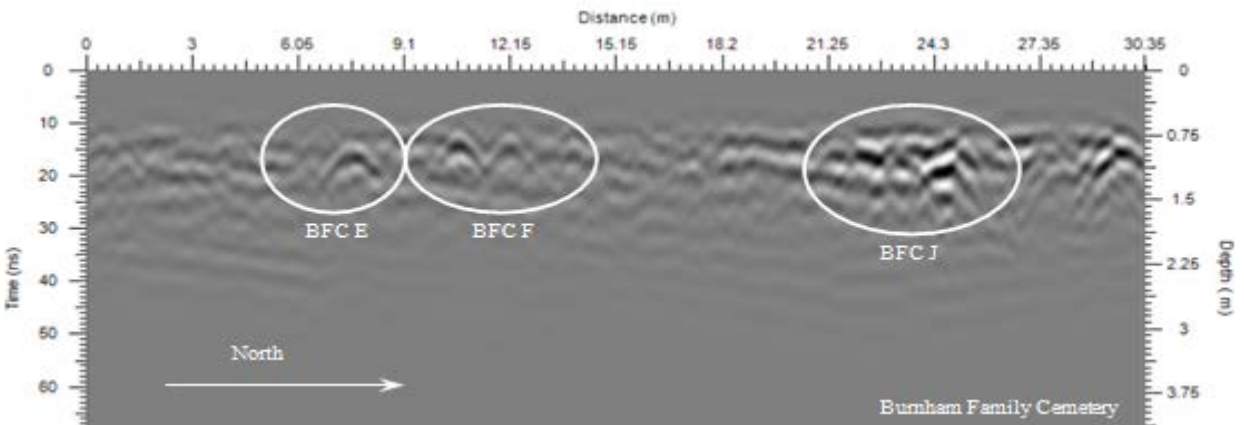

Figure 61 Burnham Family Cemetery, Transect 13, source; GPRSoft® Pro Version 2.6.4



Figure 62 Burnham Family Burial Southeastern View Source; Thomas E. Pender 45 SW Cultural Resource Manager

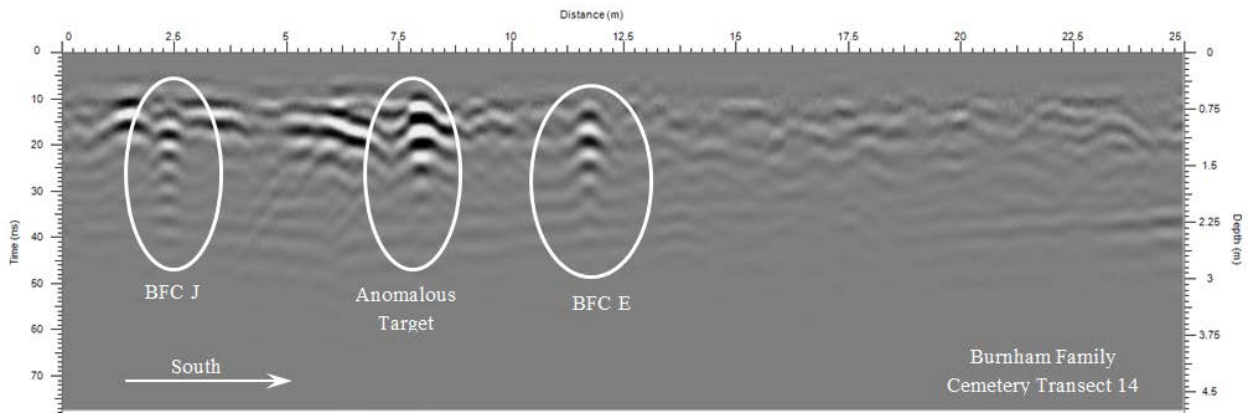

Figure 63 Burnham Family Cemetery, Transect 14, source; GPRSoft® Pro Version 2.6.4

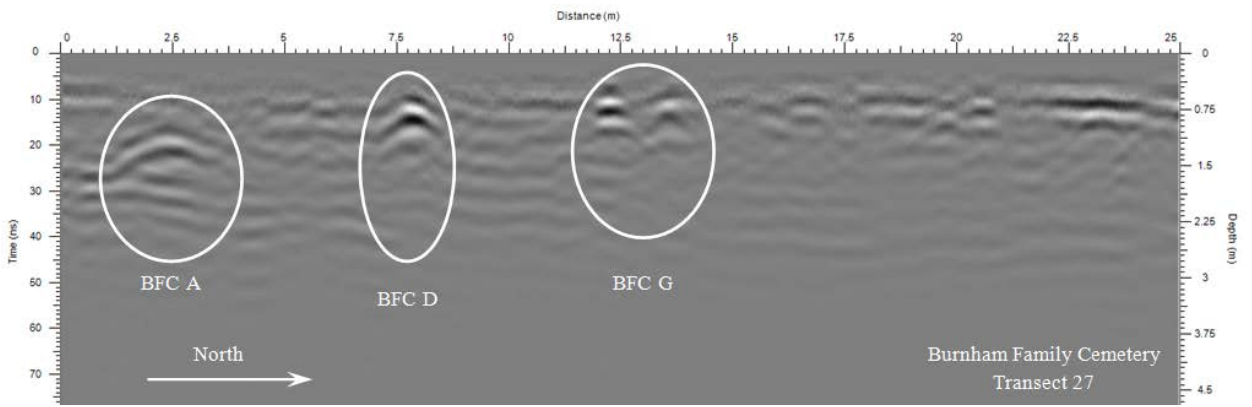

Figure 64 Burnham Family Cemetery, Transect 27, source: GPRSoft® Pro Version 2.6.4

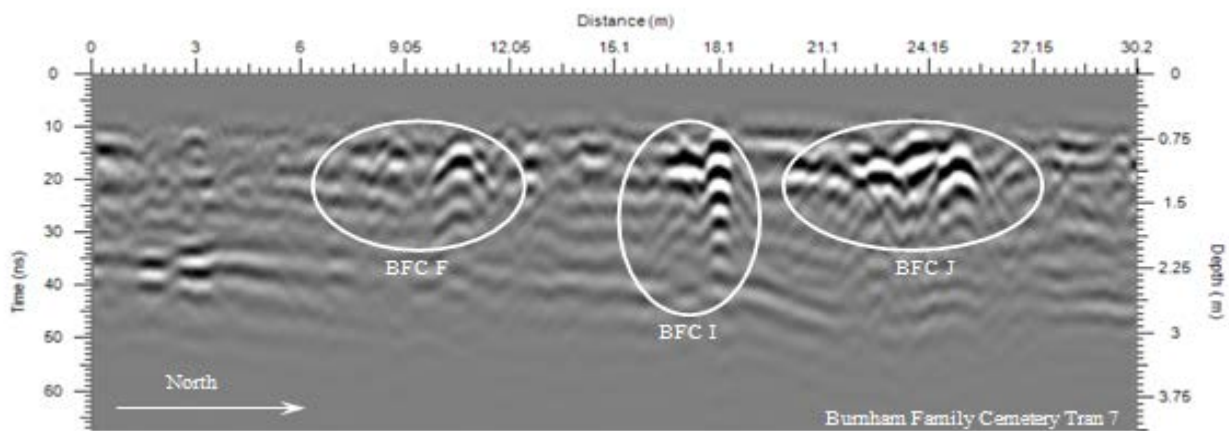

Figure 65 Burnham Family Cemetery, Transect 7, source; GPRSoft® Pro Version 2.6.4

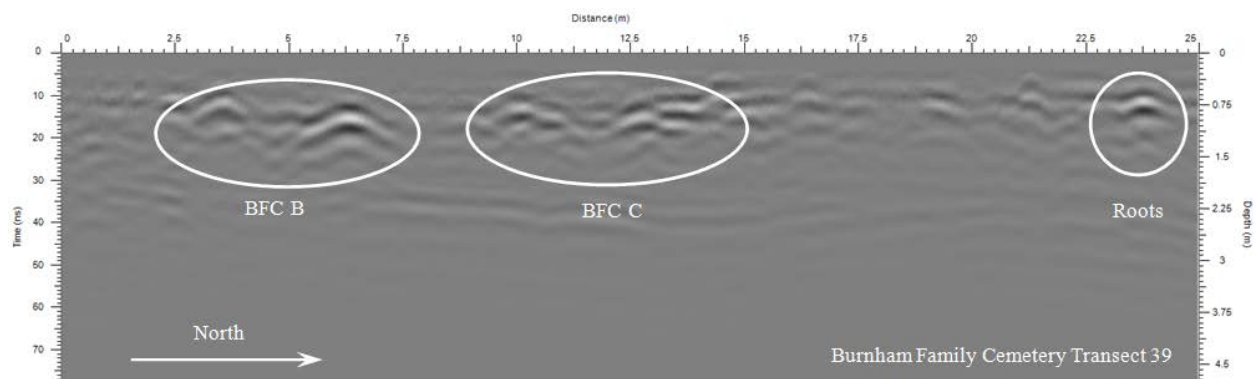

Figure 66 Burnham Family Cemetery, Transect 39, source; GPRSoft® Pro Version 2.6.4

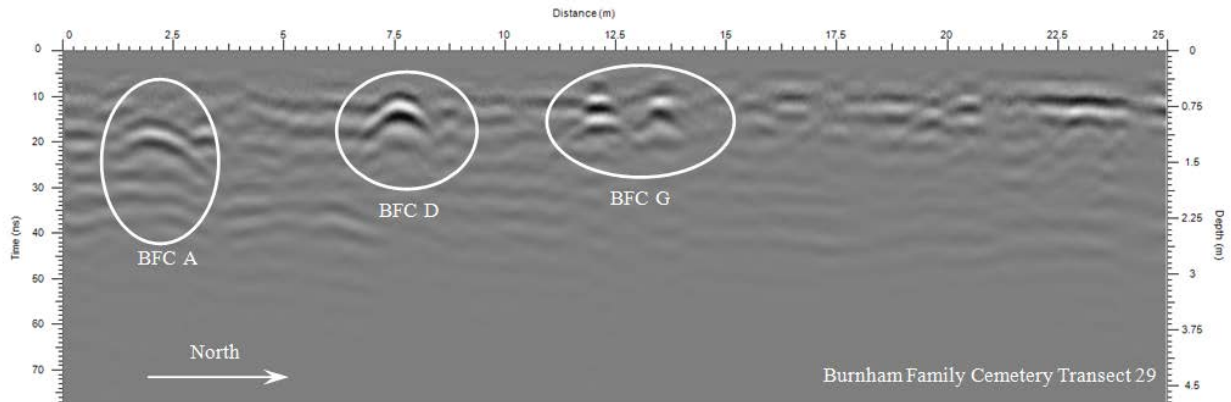

Figure 67 Burnham Family Cemetery, Transect 29, source; GPRSoft® Pro Version 2.6.4

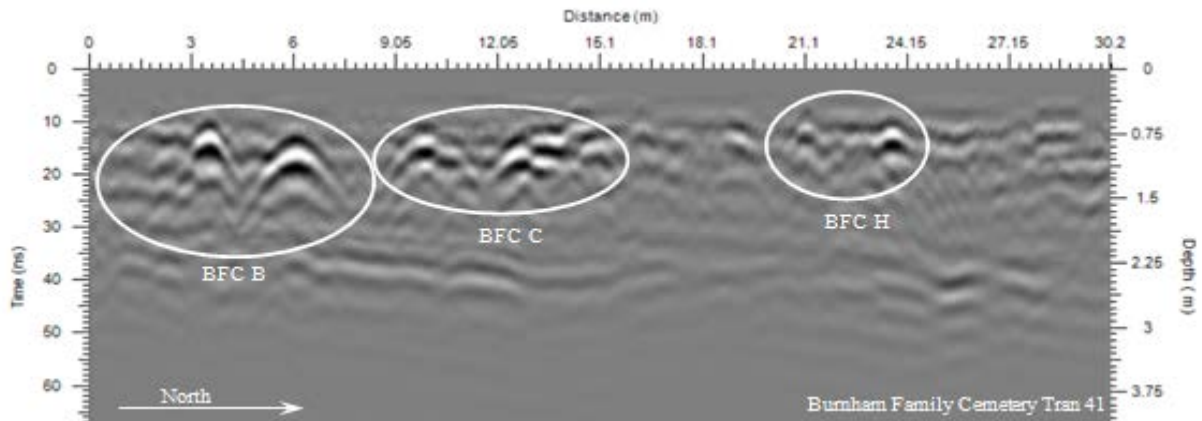

Figure 68 Burnham Family Cemetery, Transect 41, source; GPRSoft® Pro Version 2.6.4

APPENDIX B: CALIBRATION DAY 1 CAPE ROAD CEMETERY

Cape Road Cemetery Day 1 Calibration Info Sheet for the GPR survey and the GPRSoft slice analysis

The survey calibrations for MAIA GPR unit with 250 amp antenna conducted on the 15 August 2010 at Cape Canaveral Air Station, Brevard County Florida.

Time Window	84.1494
Sampling Frequency	1877.61
Number Samples	158
Time 0 (zero)	51229
Stacks	1
Grid Size	13 x 34.14 meters
Transect Interval	.5 m

GPRSoft Calibrations for Macro data set for analysis of Slice Profiles and Horizontal Slices

Samples	1587
Frequency	1877.612549
Frequency Steps	110
Signal Position	69.265913
Raw Signal Position	51229
Distance Flag	1
Time Flag	0
Program Flag	0
External Flag	0
Time Interval	0.000000
Distance Interval	0.057670
Operator	Dr. Sarah Barber; William Boynton
Customer	Cape Canaveral Air Force Station
Site	Cape Road Cemetery
Antennas	250 MHz shielded
Antenna Orientation	Not valid field
Antenna Separation	0.0310000
Comments	
Time Window	84.149418
Stacks	1
Stack Exponent	0
Stacking Time	0.001580
Last Trace	596
Stop Position	34.371396

System Calibration	0.0000048417
Start Position	0.000000
Short Flag	1
Intermediate Flag	0
Long Flag	0
Preprocessing	0
High	0
Low	0
Fixed Increment	0.300000
Fixed Moves Up	0
Fixed Moves Down	1
Fixed Position	0.000000
Wheel Calibration	346.800000
Positive Direction	-1
Dielectric Constant	6
Amount of Traces	604

APPENDIX C: CALIBRATION DAY 2 CAPE ROAD CEMETERY

Cape Road Cemetery Day 2 Calibration Info Sheet for the GPR survey and the GPRSoft slice analysis

The survey calibrations for MAIA GPR unit with 250 amp antenna conducted on the 16 August 2010 at Cape Canaveral Air Station, Brevard County Florida.

Time Window	84.1494
Sampling Frequency	1877.61
Number Samples	158
Time 0 (zero)	51229
Stacks	1
Grid Size	26.5 x 34.14 meters
Transect Interval	.5 m

GPRSoft Calibrations for Macro data set for analysis of Slice Profiles and Horizontal Slices

Samples	158
Frequency	1877.612549
Frequency Steps	110
Signal Position	69.265913
Raw Signal Position	51229
Distance Flag	1
Time Flag	0
Program Flag	0
External Flag	0
Time Interval	0.000000
Distance Interval	0.057670
Operator	Dr. Sarah Barber; William Boynton
Customer	Cape Canaveral Air Force Station
Site	Cape Road Cemetery Day 2
Antennas	250 MHz shielded
Antenna Orientation	Not valid field
Antenna Separation	0.0310000
Comments	
Time Window	84.149418
Stacks	1
Stack Exponent	0
Stacking Time	0.001580
Last Trace	597
Stop Position	34.429066
	143

System Calibration	0.0000048417
Start Position	0.000000
Short Flag	1
Intermediate Flag	0
Long Flag	0
Preprocessing	0
High	0
Low	0
Fixed Increment	0.300000
Fixed Moves Up	0
Fixed Moves Down	1
Fixed Position	0.000000
Wheel Calibration	346.800000
Positive Direction	-1
Dielectric Constant	6
Amount of Traces	605

APPENDIX D: CAPE ROAD CEMETRY GRID 2, .50 M

Cape Road Cemetery Grid 2 Calibration Info Sheet for the GPR survey and the GPRSoft slice analysis

The survey calibrations for MAIA GPR unit with 250 amp antenna conducted on the 16 August 2010 at Cape Canaveral Air Station, Brevard County Florida.

Time Window	90.2694
Sampling Frequency	1750.32
Time 0 (zero)	51645
Stacks	1
Stack time	0.00158
Grid Size	20 x 40 meters
Transect Interval	.5 meter

GPRSoft Calibrations for Macro data set for analysis of Slice Profiles and Horizontal Slices

Samples	158
Frequency	1877.61249
Frequency Steps	110
Signal Position	69.265913
Raw Signal Position	51229
Distance Flag	1
Time Flag	0
Program Flag	0
External Flag	0
Time Interval	0.000000
Distance Interval	0.057670
Operator	Dr. Sarah Barber; William Boynton
Customer	Cape Canaveral Air Force Station
Site	Cape Road Cemetery Grid 2
Antennas	250 MHz shielded
Antenna Orientation	Not valid field
Antenna Separation	0.3100000
Comments	
Time Window	84.149418
Stacks	1
Stack Exponent	0
Stacking Time	0.001580
Last Trace	598
Stop Position	34.486736
	146

System Calibration	0.0000048417
Start Position	0.000000
Short Flag	1
Intermediate Flag	0
Long Flag	0
Preprocessing	0
High	0
Low	0
Fixed Increment	0.300000
Fixed Moves Up	0
Fixed Moves Down	1
Fixed Position	0.000000
Wheel Calibration	346.800000
Positive Direction	-1
Dielectric Constant	6
Amount of Traces	606

APPENDIX E: CAPE ROAD CEMETERY GRID 2, .25 M

Cape Road Cemetery Grid 2 Calibration Info Sheet for the GPR survey and the GPRSoft slice analysis

The survey calibrations for MAIA GPR unit with 250 amp antenna conducted on the 10 January 2013 at Cape Canaveral Air Station, Brevard County Florida.

Time Window	96.476485
Sampling Frequency	1844.08
Number Samples	246
Time 0 (zero)	50258
Stacks	1
Trig Int	.05

GPRSoft Calibrations for Macro data set for analysis of Slice Profiles and Horizontal Slices

Samples	246
Frequency	2549.844238
Frequency Steps	81
Signal Position	73.967241
Raw Signal Position	50258
Distance Flag	1
Time Flag	0
Program Flag	0
External Flag	0
Time Interval	0.000000
Distance Interval	0.049020
Operator	Dr. Sarah Barber; William Boynton
Customer	Cape Canaveral Air Force Station
Site	Burnham Cemetery
Antennas	250 MHz shielded
Antenna Orientation	Not valid field
Antenna Separation	0.0360000
Comments	
Time Window	94.476485
Stacks	1
Stack Exponent	0
Stacking Time	0.002460
Last Trace	616
Stop Position	24.558824
System Calibration	0.0000048417

Start Position	0.000000
Short Flag	1
Intermediate Flag	0
Long Flag	0
Preprocessing	0
High	0
Low	0
Fixed Increment	0.300000
Fixed Moves Up	0
Fixed Moves Down	1
Fixed Position	0.000000
Wheel Calibration	346.800000
Positive Direction	-1
Dielectric Constant	6
Amount of Traces	505

APPENDIX F: QUARTERMAN SOTH CEMETERY GRID 1

Quarterman South Grid 1 Calibration Info Sheet for the GPR survey and the GPRSoft slice analysis

The survey calibrations for MAIA GPR unit with 250 amp antenna conducted on the 9 September 2010 at Cape Canaveral Air Station, Brevard County Florida.

Time Window	97.6095
Sampling Frequency	2151.43
Number Samples	210
Time 0 (zero)	50705
Stacks	1
Trig Int	.1m
Stack Time	.0021
Grid Size	15x15 meter
Transect Interval	.5 meter

GPRSoft Calibrations for Macro data set for analysis of Slice Profiles and Horizontal Slices

Samples	210
Frequency	2151.430908
Frequency Steps	96
Signal Position	71.802984
Raw Signal Position	50705
Distance Flag	1
Time Flag	0
Program Flag	0
External Flag	0
Time Interval	0.000000
Distance Interval	0.09839
Operator	Dr. Sarah Barber; William Boynton
Customer	Cape Canaveral Air Force Station
Site	Burnham Cemetery
Antennas	250 MHz shielded
Antenna Orientation	Not valid field
Antenna Separation	0.0360000
Comments	
Time Window	97.609451
Stacks	1
Stack Exponent	0
Stacking Time	0.002100
Last Trace	135
	152

Stop Position	13.235294
System Calibration	0.0000048417
Start Position	0.000000
Short Flag	1
Intermediate Flag	0
Long Flag	0
Preprocessing	0
High	0
Low	0
Fixed Increment	0.300000
Fixed Moves Up	0
Fixed Moves Down	1
Fixed Position	0.000000
Wheel Calibration	346.800000
Positive Direction	-1
Dielectric Constant	6
Amount of Traces	136

APPENDIX G: QUARTERMAN SOUTH GRID 2

Quarterman Cemetery South Grid 2 Calibration Info Sheet for the GPR survey and the GPRSoft slice analysis

The survey calibrations for MAIA GPR unit with 250 amp antenna conducted on the 9 September 2010 at Cape Canaveral Air Station, Brevard County Florida.

Time Window	97.6095
Sampling Frequency	2151.43
Number Samples	210
Time 0 (zero)	50705
Stacks	1
Trig Int	.1
Stack Time	.0021
Grid Size	10x15.2 meters
Transect Interval	.5 meter

GPRSoft Calibrations for Macro data set for analysis of Slice Profiles and Horizontal Slices

Samples	210
Frequency	2151.430908
Frequency Steps	96
Signal Position	71.802984
Raw Signal Position	50705
Distance Flag	1
Time Flag	0
Program Flag	0
External Flag	0
Time Interval	0.000000
Distance Interval	0.098039
Operator	Dr. Sarah Barber; William Boynton
Customer	Cape Canaveral Air Force Station
Site	Quarterman South Grid 2
Antennas	250 MHz shielded
Antenna Orientation	Not valid field
Antenna Separation	0.0360000
Comments	Difference between samples and traces
Time Window	97.609451
Stacks	1
Stack Exponent	0
Stacking Time	0.002100
Last Trace	153
	155

Stop Position	15.000000
System Calibration	0.0000048417
Start Position	0.000000
Short Flag	1
Intermediate Flag	0
Long Flag	0
Preprocessing	0
High	0
Low	0
Fixed Increment	0.300000
Fixed Moves Up	0
Fixed Moves Down	1
Fixed Position	0.000000
Wheel Calibration	346.800000
Positive Direction	-1
Dielectric Constant	6
Amount of Traces	154

APPENDIX H: QUARTERMAN SOUTH GRID 3

Quarterman South Grid 3 Calibration Info Sheet for the GPR survey and the GPRSoft slice analysis

The survey calibrations for MAIA GPR unit with 250 amp antenna conducted on the 9 September 2010 at Cape Canaveral Air Station, Brevard County Florida.

Time Window	97.6095
Sampling Frequency	2151.43
Number Samples	210
Time 0 (zero)	50705
Stacks	1
Trig Int	.1m
Stack Time	.0021
Grid Size	8 x 15.2 meters
Transect Interval	.5 meter

GPRSoft Calibrations for Macro data set for analysis of Slice Profiles and Horizontal Slices

Samples	210
Frequency	2151.430908
Frequency Steps	96
Signal Position	71.802984
Raw Signal Position	50705
Distance Flag	1
Time Flag	0
Program Flag	0
External Flag	0
Time Interval	0.000000
Distance Interval	0.098039
Operator	Dr. Sarah Barber; William Boynton
Customer	Cape Canaveral Air Force Station
Site	Quarterman South Grid 3
Antennas	250 MHz shielded
Antenna Orientation	Not valid field
Antenna Separation	0.0360000
Comments	
Time Window	91.828415
Stacks	1
Stack Exponent	0
Stacking Time	0.002100
Last Trace	75
	158

Stop Position	7.352941
System Calibration	0.0000048417
Start Position	0.000000
Short Flag	1
Intermediate Flag	0
Long Flag	0
Preprocessing	0
High	0
Low	0
Fixed Increment	0.300000
Fixed Moves Up	0
Fixed Moves Down	1
Fixed Position	0.000000
Wheel Calibration	346.800000
Positive Direction	-1
Dielectric Constant	6
Amount of Traces	76

APPENDIX I: QUARTERMAN NORTH CEMETERY

Quarterman North Grid 1 and Grid 2 Calibration Info Sheet for the GPR survey and the GPRSoft slice analysis

The survey calibrations for MAIA GPR unit with 250 amp antenna conducted on the 15 September 2010 at Cape Canaveral Air Station, Brevard County Florida.

Time Window	97.6095
Sampling Frequency	12151.43
Number Samples	210
Time 0 (zero)	50705
Stacks	1
Trig Int	.1m
Stack Time	.0021
Grid Size	14x7.5 meters
Transect Interval	.5 m

GPRSoft Calibrations for Macro data set for analysis of Slice Profiles and Horizontal Slices

Samples	174
Frequency	1894.838257
Frequency Steps	96
Signal Position	71.802984
Raw Signal Position	50705
Distance Flag	1
Time Flag	0
Program Flag	0
External Flag	0
Time Interval	0.000000
Distance Interval	0.049020
Operator	Dr. Sarah Barber; William Boynton
Customer	Cape Canaveral Air Force Station
Site	Quarterman North Grid 1
Antennas	250 MHz shielded
Antenna Orientation	Not valid field
Antenna Separation	0.0360000
Comments	
Time Window	97.609451
Stacks	1
Stack Exponent	0
Stacking Time	0.002100
Last Trace	275
	161

Stop Position	13.480392
System Calibration	0.0000048417
Start Position	0.000000
Short Flag	1
Intermediate Flag	0
Long Flag	0
Preprocessing	0
High	0
Low	0
Fixed Increment	0.300000
Fixed Moves Up	0
Fixed Moves Down	1
Fixed Position	0.000000
Wheel Calibration	346.800000
Positive Direction	-1
Dielectric Constant	6
Amount of Traces	278

APPENDIX J: BURNHAM CEMTERY GRID 1

Burnham Cemetery Grid 1 Calibration Info Sheet for the GPR survey and the GPRSoft slice analysis

The survey calibrations for MAIA GPR unit with 250 amp antenna conducted on the 5 October 2010 at Cape Canaveral Air Station, Brevard County Florida.

Time Window	91.8284
Sampling Frequency	1844.08
Number Samples	174
Time 0 (zero)	51249
Stacks	1
Trig Int	.05
Grid Size	31 x 11 meters
Transect Interval	.25m

GPRSoft Calibrations for Macro data set for analysis of Slice Profiles and Horizontal Slices

Samples	174
Frequency	1894.838257
Frequency Steps	109
Signal Position	69.169078
Raw Signal Position	51249
Distance Flag	1
Time Flag	0
Program Flag	0
External Flag	0
Time Interval	0.000000
Distance Interval	0.049020
Operator	Dr. Sarah Barber; William Boynton
Customer	Cape Canaveral Air Force Station
Site	Burnham Cemetery Grid 1
Antennas	250 MHz shielded
Antenna Orientation	Not valid field
Antenna Separation	0.0360000
Comments	
Time Window	91.828415
Stacks	1
Stack Exponent	0
Stacking Time	0.001740
Last Trace	616
	164

Stop Position	30.196078
System Calibration	0.0000048417
Start Position	0.000000
Short Flag	1
Intermediate Flag	0
Long Flag	0
Preprocessing	0
High	0
Low	0
Fixed Increment	0.300000
Fixed Moves Up	0
Fixed Moves Down	1
Fixed Position	0.000000
Wheel Calibration	346.800000
Positive Direction	-1
Dielectric Constant	6
Amount of Traces	623

APPENDIX K: BURNHAM CEMETERY GRID 2

Burnham Cemetery Grid 2 Calibration Info Sheet for the GPR survey and the GPRSoft slice analysis

The survey calibrations for MAIA GPR unit with 250 amp antenna conducted on the 5 October 2010 at Cape Canaveral Air Station, Brevard County Florida.

Time Window	91.8284
Sampling Frequency	1844.08
Number Samples	174
Time 0 (zero)	51249
Stacks	1
Trig Int	.05
Grid Size	3 x 7 meters
Transect Interval	.5m

GPRSoft Calibrations for Macro data set for analysis of Slice Profiles and Horizontal Slices

Samples	174
Frequency	1894.838257
Frequency Steps	109
Signal Position	69.169078
Raw Signal Position	51249
Distance Flag	1
Time Flag	0
Program Flag	0
External Flag	0
Time Interval	0.000000
Distance Interval	0.049020
Operator	Dr. Sarah Barber; William Boynton
Customer	Cape Canaveral Air Force Station
Site	Burnham Cemetery Grid 2 (Small southwest corner)
Antennas	250 MHz shielded
Antenna Orientation	Not valid field
Antenna Separation	0.0360000
Comments	
Time Window	91.828415
Stacks	1
Stack Exponent	0
Stacking Time	0.001740

167

Last Trace	50
Stop Position	30.196078
System Calibration	0.0000048417
Start Position	0.000000
Short Flag	1
Intermediate Flag	0
Long Flag	0
Preprocessing	0
High	0
Low	0
Fixed Increment	0.300000
Fixed Moves Up	0
Fixed Moves Down	1
Fixed Position	0.000000
Wheel Calibration	346.800000
Positive Direction	-1
Dielectric Constant	6
Amount of Traces	51

APPENDIX L: TABLES

Table 1 Cape Road Cemetery Burial Summary

Map Identifier Number	Burial Occupant	Burial Chronology	Years Interred	Grave Markers	Geophysical Anomalies	Interpretation
1	Jeffords, Samuel	d. 11 Nov. 1940	71 years	Original	None	Age and environment destruction
2	Jeffords, Julia	d. 27 Mar. 1921	90 years	Original	None	Age and environment destruction
3	Jeffords, Joseph	d. 12 Dec. 1894	117 years	Original	None	Age and environment destruction
4	Carlisle, Busie	d. 7 Dec. 1937	74 years	Original	Yes	Related to a Burial
5	Hardin, Thomas	d. 12 Nov. 1937	74 years	Original	None	Age and environment destruction
6	Hardin, A. Belle	d. 24 Jul. 1932	79 years	Original	None	Age and environment destruction
7	Jandreau, Charles	d. 1937	74 years	Original	None	Age and environment destruction
8	Jandreau, Veda K.	d. 11 Sept. 1942	69 years	Original	None	Age and environment destruction
9	Jandreau, Nicholas	d. 17 Jun. 1931	80 years	Original	None	Age and environment

						destruction
10	King, Daniel B.	d. 12 Mar. 1923	88 years	Original	None	Age and environment destruction
11	Terryn, Charles	d. 12 Jan 1949	62 years	Original	None	Age and environment destruction
12	Whidden, Allee	d. 13 Oct. 1945	66 years	Original	None	Age and environment destruction
13	Whidden, Willoughby	d. 30 Apr. 1931	70 years	Original	None	Age and environment destruction
14	Makowsky, William	d. 12 Mar. 1881	130 years	Original	None	Age and environment destruction
15	Atkinson (infant)	d. 16 Jun. 1933	78 years	Original	None	Age and environment destruction
16	Letasky, Margarete	d. 10 Feb. 1948	63 years	Modern	Yes	Related to a burial
17	Aunt of Kate Morgan	No date	? years	None	yes	Related to a burial
18	Whidden	No date	? years	None	yes	Related to a burial
19	Whidden, Pixie	d. Apr. 1929	82 years	Modern	Yes	Related to a burial

20	Syfrett, Hubert	d. 31 Dec. 1931	80 years	Original	None	Age and environment destruction
21	Easterlin, John	d. Dec. 1930	81 years	Modern	Yes	Related to a burial
22	No Names	No date	- years	Original	None	Age and environment destruction
23	Lewis, Ben	No date	-years	None	None	Age and environment destruction

Table 2 Cape Road Cemetery Feature Characteristics

Feature Number	Feature Transects	Feature Surface Area	Possible Interpretation
CRC A	Day 1 T7-T16	35 m ²	Burial relationship
CRC B	Day 1 T7-T10	15 m ²	Natural/burial relationship
CRC C	Day 2 T39-T45	20 m ²	Burial relationship
CRC D	Day 2 T51-T62	18 m ²	Loci of geophysical targets E-W dispersion (Multi-point)
CRC E	Day 2 T17-T27	20 m ²	Natural/floral relationship
CRC F	Day 2 T16-T19	6 m ²	Loci of geophysical targets E-W dispersion (3 point)
CRC G	Day 2 T68-T71	9 m ²	Burial relationship

Table 3 Cape Road Cemetery Grid 2 Feature Characteristics

Feature Number	Feature Transects	Feature Surface Area	Possible Interpretation
CRC G2 A	T16-T21	15 m ²	Loci of geophysical targets E-W dispersion (2 points)
CRC G2 B	T21-T33	3 m ²	Loci of geophysical targets E-W dispersion (Multi-point)
CRC G2 C	T53-T54	2 m ²	Loci of geophysical targets E-W dispersion (2 points)
CRC G2 D	T59-T60	1.5 m ²	Loci of geophysical targets E-W dispersion (2 points)
CRC G2 E	T92-T93	2.25 m ²	Loci of geophysical targets E-W dispersion (2 points)

Table 4 Quarterman South Cemetery, Grid 2 and Grid3

Map Identifier Number	Burial Occupant	Burial Chronology	Years Interred	Grave Markers	Geophysical Anomalies	Interpretation
1	Quarterman, William	d. 25 Dec 1869	142 years	Modern	None	Age and environment destruction
2	Quarterman, Mary	d. 15 Mar. 1878	133 years	Original	None	Age and environment destruction
3	Quarterman, Ver***a	d. 24 Oct. 1888	123 years	Original	None	Age and environment destruction

Table 5 Quarterman South Cemetery Grid 1, Grid 2, Grid 3 Feature Characteristics

Feature Number	Feature Transects	Feature Surface Area	Possible Interpretation
QSG1 A	T2	1 m ²	Anomalous geophysical target
QSG1 B	T13-T15	4 m ²	Natural/floral relationship
QSG1 C	T13-T15	3 m ²	Natural/burial relationship
QSG1 D	T19-T21	3 m ²	Anomalous geophysical target
QSG1 E	T25-T28	5 m ²	Natural/burial relationship
QSG2 A	T9-T10	2 m ²	Loci of geophysical targets E-W dispersion (2 points)
QSG2 B	T9-T12	2 m ²	Loci of geophysical targets E-W dispersion (3 point)
QSG2 C	T7-T12	5.25 m ²	Loci of geophysical targets E-W dispersion (Multi-point)
QSG2 D	T7-T8	.75 m ²	Loci of geophysical targets E-W dispersion (2 point)
QSG2 E	T1-T3	4 m ²	Natural/floral relationship
QSG3 A	T29-T30	2.25 m ²	Loci of geophysical targets E-W dispersion (2 point)
QSG3 B	T46-T47	2.25 m ²	Anomalous geophysical target

Table 6 Quarterman North Cemetery

Map Identifier Number	Burial Occupant	Burial Chronology	Years Interred	Grave Markers	Geophysical Anomalies	Interpretation
1	Quarterman, George M.	d. 1923	88 years	Modern	None	Not part of the survey
2	Quarterman, Anna D.	d. 1945	66 years	Modern	None	Not part of the survey

Table 7 Burnham Family Cemetery Summary

Map Identifier Number	Burial Occupant	Burial Chronology	Years Interred	Geophysical Anomalies	Grave Marker	Interpretation
1	Burnham, Mills	d. 17 Apr. 1886	125 years	None	Original	Age and environment destruction
2	Burnham, Mary	d. 25 Jun. 1888	123 years	None	Modern	Age and environment destruction
3	Wilson, Frances	d. 2 Oct. 1924	87 years	Yes	Original	Burial
4	Wilson, Henry	d. 14 Apr. 1917	94 years	Yes	Original	Burial
5	Burns, Elliot	d. 28 Dec. 1896	115 years	None	Original	Age and environment destruction
6	Butler, Harold	d. 13 Aug. 1914	97 years	None	Original	Age and environment destruction
7	Thomas Thompson	d. 13 Jan. 1922	89 years	No survey	Original	Not part of the survey
8	Henrietta Thompson	d. 18 Jan. 1922	89 years	No survey	Modern	Not part of the survey

Table 8 Burnham Family Cemetery Feature Characteristics

Feature Number	Feature Transects	Feature Surface Area	Possible Interpretation
BFC A	T27-T32	3 m ²	Loci of geophysical targets E-W dispersion (Multi-point)
BFC B	T37-T43	5 m ²	Loci of geophysical targets E-W dispersion (Multi-point)
BFC C	T35-T43	5 m ²	Loci of geophysical targets E-W dispersion (Multi-point)
BFC D	T20-T32	8.75 m ²	Loci of geophysical targets E-W dispersion (Multi-point)
BFC E	T11-T14	2.25 m ²	Natural/floral relationship
BFC F	T5-T13	5 m ²	Natural/burial relationship
BFC G	T27-T29	3 m ²	Loci of geophysical targets E-W dispersion (Multi-point)
BFC H	T41-T43	1.5 m ²	Loci of geophysical targets E-W dispersion (2 point)
BFC I	T2-T7	4 m ²	Loci of geophysical targets E-W dispersion (Multi-point)
BFC J	T2-T14	10.5 m ²	Loci of geophysical targets E-W dispersion (Multi-point)

Table 9 Summary of CCAFS Anomalous Features

Feature number	Cemetery	GPR evidence for Burials	Number of Potential Burials
CRC A	Cape Road Cemetery	Loci of geophysical targets E-W dispersion (Multi-point)	3
CRC C	Cape Road Cemetery	Loci of geophysical targets E-W dispersion (Multi-point)	2 or 3
CRC D	Cape Road Cemetery	Loci of geophysical targets E-W dispersion (Multi-point)	1
QSG2 C	Quarterman South Cemetery	Loci of geophysical targets E-W dispersion (Multi-point)	1
QSG3 A	Quarterman South Cemetery	Loci of geophysical targets E-W dispersion (Multi-point)	1
BFC A	Burnham Family Cemetery	Loci of geophysical targets E-W dispersion (Multi-point)	1
BFC I	Burnham Family Cemetery	Loci of geophysical targets E-W dispersion (Multi-point)	1

APPENDIX M: POINT PLOT TABLES AND MAPS

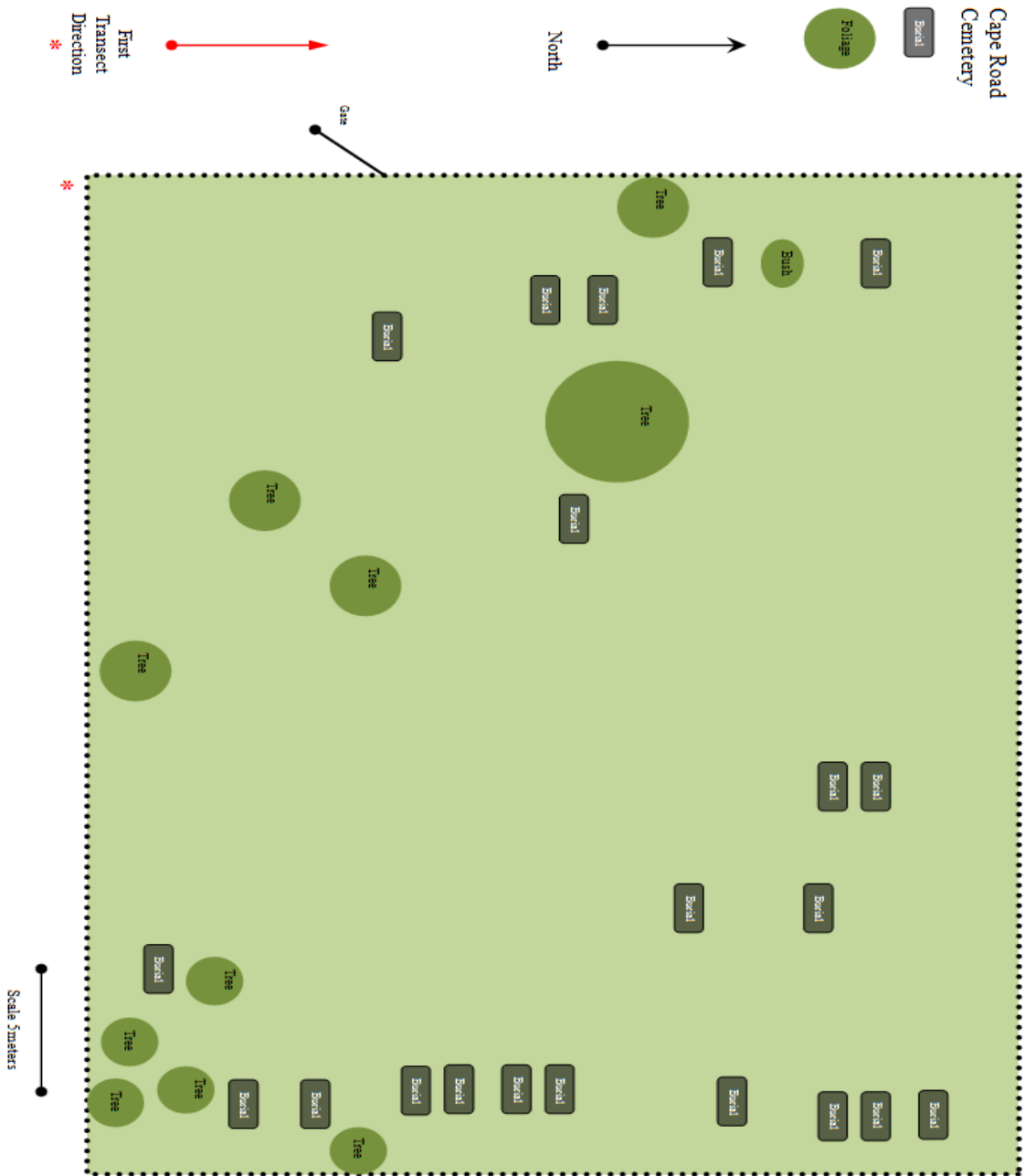

Cape Road Cemetery Survey Point Plot Reference Sheet

The Cape Road Cemetery GPR survey was conducted on consecutive days. The first day survey consisted of 26 transects covering 13m with a transect interval of 50 cm. The first transect began at 50cm and travel north then south alternately. The second survey conducted on the next day consisted of 52 transects covering 25.5m with a transect interval of 50 cm. The first transect in this survey began at 13.5m and travel north then south alternately (Figure 22).

Cape Road Cemetery Day 1

Transect	Transect Direction	Time/ns	Distance/m	Depth/cm	Interpretation
7	N	7.4	16.1	48	
		8.2	18.9	50	
		9.2	26.6	56	
		13.8	28.1	85	
8	S	14.8	6.8	91	
		14.2	8.5	87	
		8.2	16.1	50	
		15	18.7	59	
		9.1	19.6	58	
10	S	12	16.5	73	
11	N	7.6	3.7	47	
		7.7	25.8	47	
		6.9	30.2	42	
		6.4	31.4	39	

12	S	8.1	4.1	51	
		8.6	5.1	53	
		9.4	6.9	53	
		10.9	9.2	67	
13	N	9.4	26.6		
		3.8	29.7		
		7.7	30.5		
14	S	3.8	4.1	65	
		10.5	7	41	
		6.6	9.2	49	

Cape Road Cemetery Day 2

Transect	Transect Direction	Time/NS	Distance	Depth	Interpretation
12	S	11.2	2.4	69	
		11.7	8.6	72	
17	N	8.8	2.1	54	
		10	6	61	
		6.7	29.7	41	

21	S	10.7	1.3	66	
		6.4	29.9	39	
22	N	8.8	.4	54	
		8.1	1.4	50	
		8.1	4.1	50	
		9.8	32.4	60	
23	S	11.9	1.4	73	
		5.2	31	32	
27	S	26.9	14.5	145	
		11.9	25.1	64	
		9.3	31.2	50	
39	S	6.9	4.9	42	
40	N	6.6	29.5	40	
		7.4	31.6	45	
43	N	6.2	29.6	38	
45	S	6.2	4.8	38	
51	S	9.1	12	56	
		8.2	16.9	50	

56	S	5.9	16.3	36	
		6.6	17.7	40	
57	N	7.3	17.2	45	
		5.1	18.5	31	
62	N	6.4	18.1	39	
68	S	9.7	9.4	59	
69	N	6.7	25.7	41	
71	S	8.3	10.6	51	
73	S	4.8	20.1	29	
		6	24.7	37	

CRC Grid 2

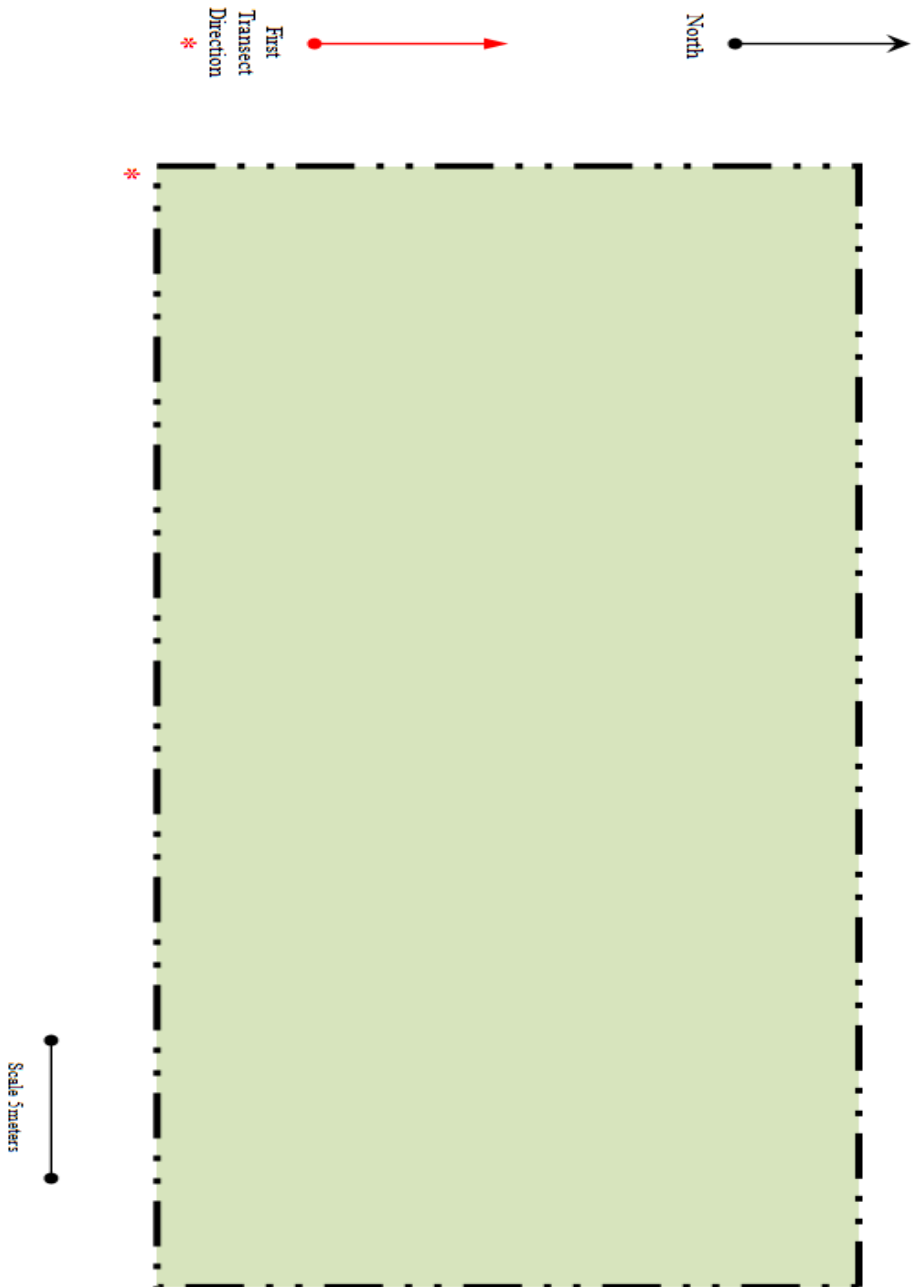

Cape Road Cemetery Grid 2 Survey Point Plot Reference Sheet

The Cape Road Cemetery Grid 2 GPR survey was conducted in one day. This survey consisted of 161 transects covering a 25m by 40.50m rectangle with a transect interval of 25 cm. The first transect began at 0.0m mark and traveled north then south alternately through the remainder of the survey (Figure 35).

CRC Grid 2 (.50m) survey

Transect	Transect Direction	Time/ns	Distance/m	Depth/cm	Interpretation
5	N	10.4	16.9	64	
10	N	10.7	6.8	66	
16	S	9.9	17.7	61	
21	S	9.4	4.3	58	
		9.9	17.6	61	
24	N	7.2	15.8	44	
28	N	8.2	.2	50	
		5.7	14.5	35	
		8.2	16.6	50	
33	S	4.5	4.1	28	
38	S	34.9	10.1	214	

47	N	9.7	10.7	59	
53	N	10.9	10.9	67	
54	S	10.7	8.8	66	
59	N	4.5	15.6	28	
60	S	3.2	3.9	20	
64	N	7.7	15.2	47	
		10.9	17.5	67	
67	S	13.1	3.2	80	
		2.2	18.6	13	
69	S	5.5	16.4	34	
73	S	14.9	11.9	91	
92	N	4.2	15.8	26	
93	S	14.1	3.5	86	
101	S	5	6.1	31	
108	S	4.5	3.9	28	

Quarterman South Cemetery

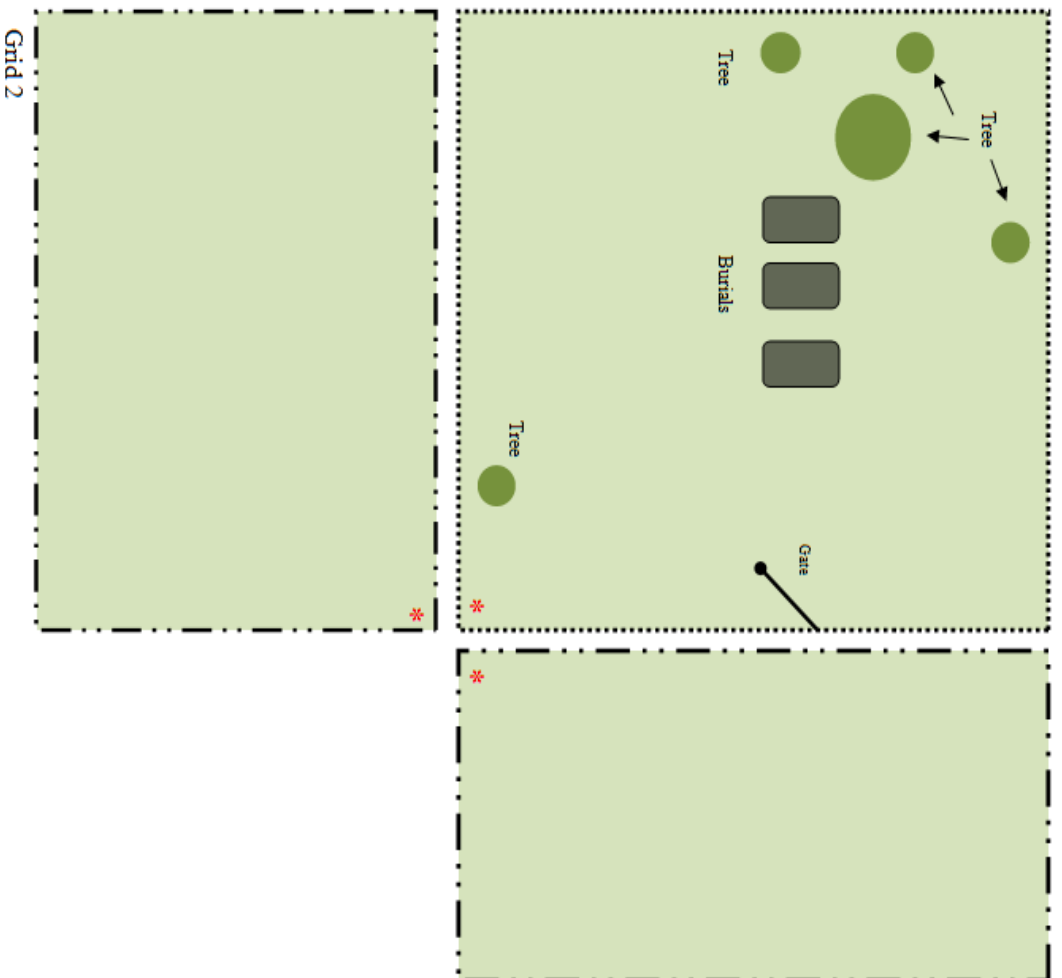
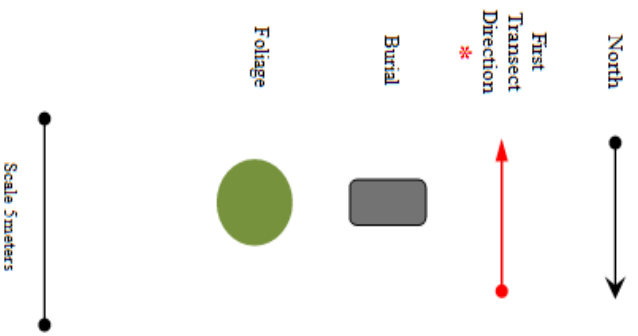

Quarterman South Cemetery, Grid 2 and Grid 3 Point Plot Reference Sheet

The Quarterman South Cemetery GPR survey was conducted in one day. The survey consisted three grids that consisted of the cemetery, a grid to west and a grid to the north. The first grid, Quarterman South cemetery is a 15.2m by 15.2m square with 30 transects. The first transect began at the .5m mark and traveled south (Figure 45). The remaining transects alternated direction until the end of the survey. Grid 2 is a 10m by 15.2m rectangle with 20 transects. The first transect began at the .5m mark and traveled north (Figure 46). The remaining transects alternated direction until the end of the survey. Grid 3 was the final surveyed area. The grid is 8m by 15.2m rectangle with 31 transects. The first transect began in the southeastern corner at the 0m mark and traveled north (Figure 47). The remaining transects then alternated direction until then end of the survey. It is noted that this grid contains a transect surveyed twice at the beginning of the grid. Based on the recorded point plots and the documented orientation of the first and last transect the area covered by transects 25 through 27 are suspect. This area contains no anomalous targets so impact is minimal to the survey conducted in this grid. A transect interval of .5m was maintained throughout the surveys.

Quarterman South Cemetery

Transect	Transect Direction	Time/ns	Distance/m	Depth/cm	Interpretation
2	S	9	.9	55	
		13.6	10.1	83	
		13	11.1	80	
4	S	5.8	5.2	36	
		15.3	9.4	94	

13	N	11 17.3 12.4	1 2 9	67 1.06 76	
15	N	15.3 11	1.4 8.4	94 67	
18	S	11.8	3.9	72	
19	N	11.3	10.3	69	
21	N	11	10.7	67	
24	S	11	6.9	67	
25	N	8.1	7.1	50	
26	S	9	6.2	55	
28	S	7.2 7.2	6.3 10.2	44 44	
30	S	9.5	5.9	58	

Quarterman South Cemetery Grid 2

Transect	Transect Direction	Time/ns	Distance/m	Depth/cm	Interpretation
1	N	12.4	3.4	76	
		13.6	10.8	83	
2	S	14.4	4.1	88	
3	N	15.3	10.8	94	
5	N	8.1	4	50	
		9.5	7	58	
7	N	15.3	9.9	94	
		15.3	11.7	94	
8	S	15	4.2	92	
		15.3	6.2	81	
		8.4	11.4	51	
9	N	15.6	1	1.05	
		14.4	9.2	97	
		13.3	13.7	89	

10	S	15.3	8.4	67	
		14.2	15.4	62	
11	N	13.6	7.1	83	
		17.3	9.1	1.06	
12	S	17.9	6.8	1.10	
		18.5	8.7	1.13	
13	N	11.8	12.9	72	
18	S	9.2	3.7	56	
		17.3	9	1.06	

Quarterman South Cemetery Grid 3

Transect	Transect Direction	Time/ns	Distance/m	Depth/cm	Interpretation
29	S	6.6	4.1	40	
30	N	12.4	4.4	76	
34	N	11.8	1.7	72	
35	S	7.8	2.8	48	

39	S	8.7	5.4	53	
41	S	5.8	2.8	36	
42	N	8.4	1.5	51	
		11.6	5	71	
46	N	7.5	2.2	46	
47	S	9.8	6	60	

Quarterman
North
Cemetery

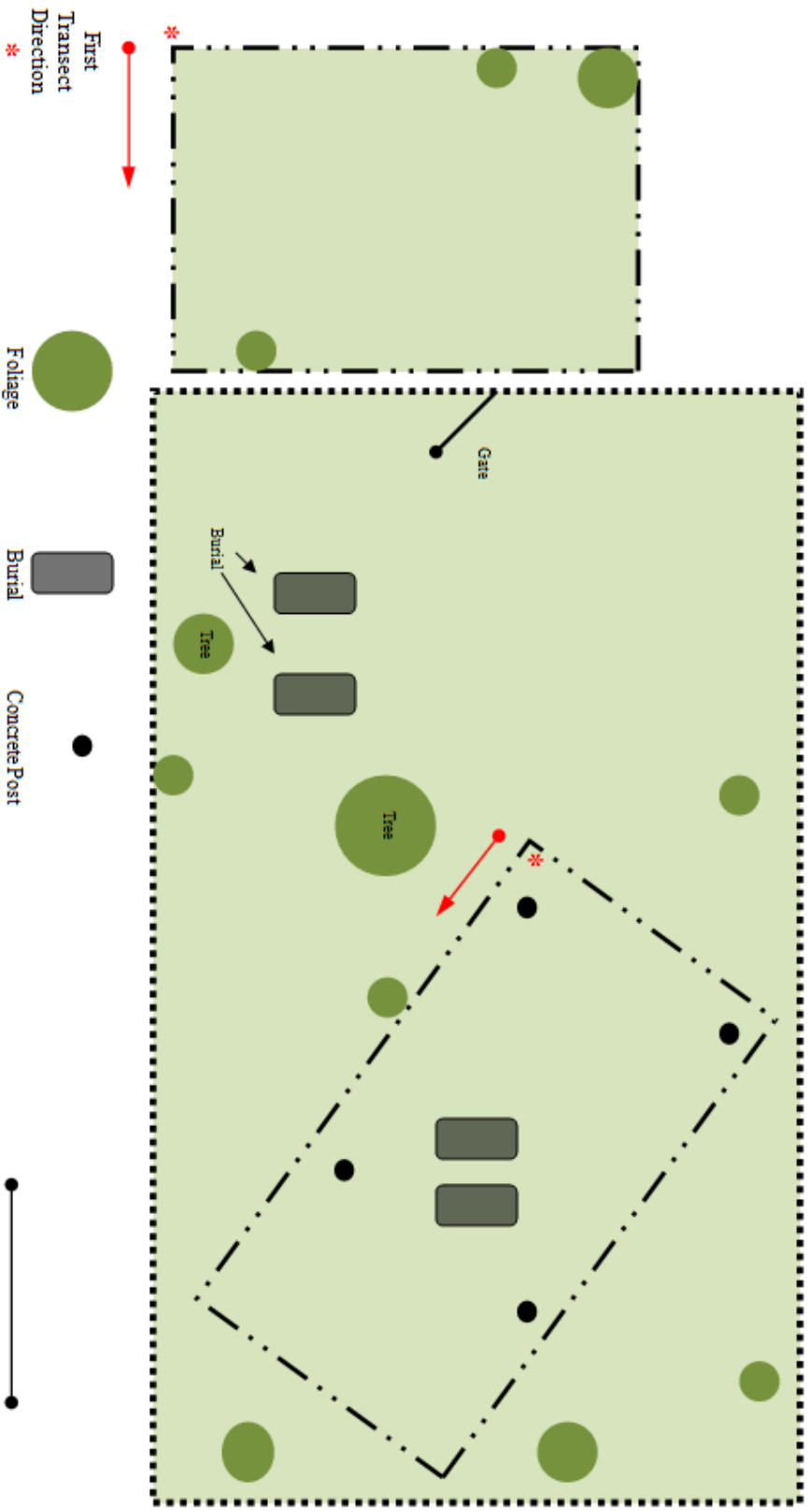

Scale 5meters

Quarterman North Cemetery Point Plot Reference Sheet

The Quarterman North Cemetery GPR survey was conducted on one day. The survey consisted of 16 transects covering 7.5m with a transect interval of 50 cm. The survey grid was offset 36 degrees east of magnetic north so the transect direction are southwest (SW) to northeast (NE). The first transect began at 50cm and travel SW then NE alternately. The second grid was an 11.5 by 8 meter rectangle with the long axis running east and west. The grid was established along Quarterman North Cemetery's northern fence line.

Quarterman North Grid 1

Transect	Transect Direction	Time/ns	Distance/m	Depth/cm	Interpretation
3	SW	12.4	1	76	Broad hyperbola
		12.4	3.8	76	
		13.6	5.2	83	
		7.1	7	43	
		9.9	8.5	61	
7	SW	11.6	4.3	71	
		16.1	6.2	99	
		6.5	8.6	40	
14	NE	17.2	6.2	105	
		16.7	8.1	102	
16	NE	16.4	5.2	100	
		17.8	8	109	

Quarterman North Grid 2

Transect	Transect Direction	Time/ns	Distance/m	Depth/cm	Interpretation
10	N	7.8	5.2	48	
13	S	9.8	1.4	60	
24	N	7.3	3.6	45	

Burnham Family Cemetery

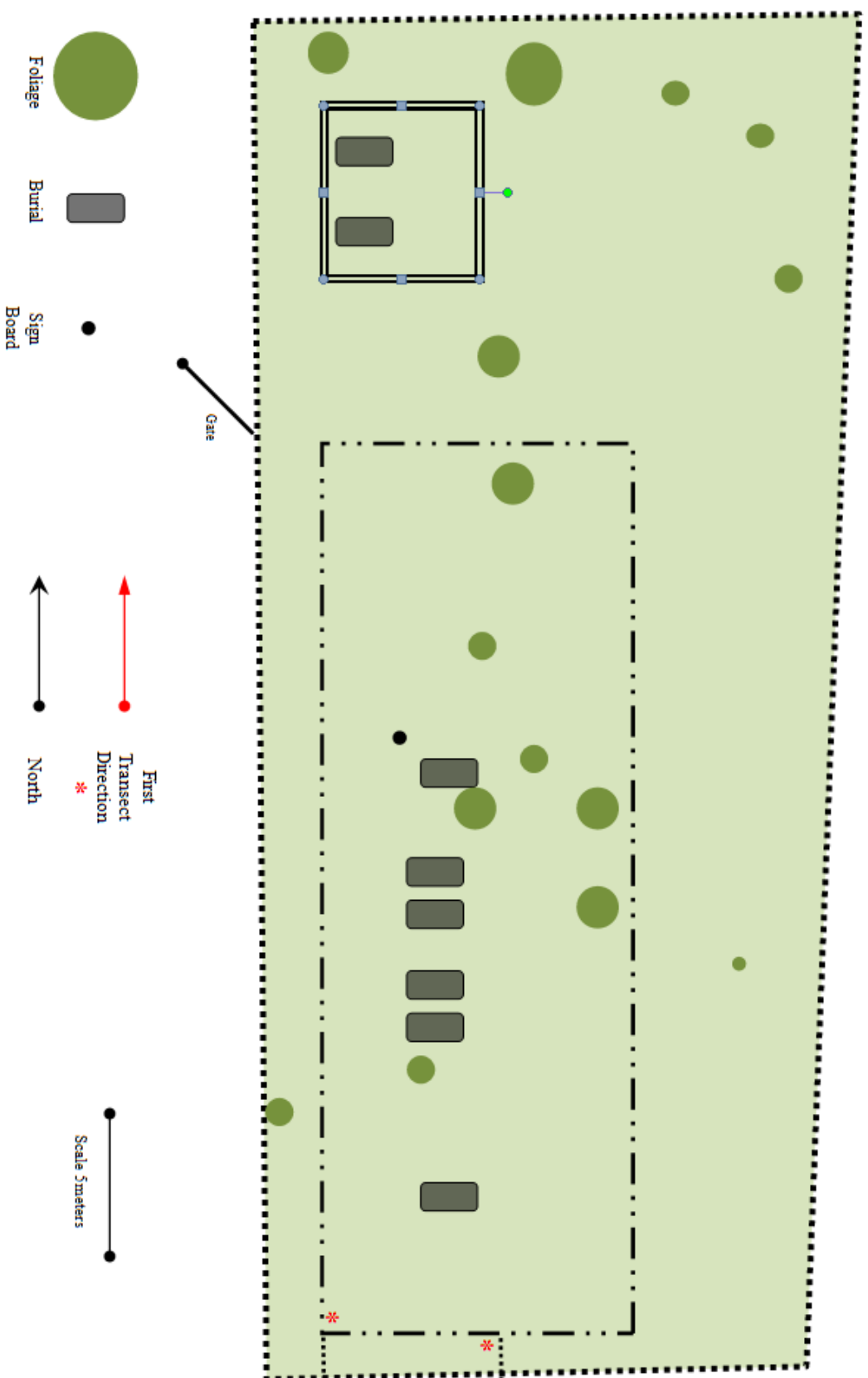

Burnham Cemetery Survey Point Plot Reference Sheet

The Burnham GPR survey was conducted in a single day and contained 2 survey grids. The first grid, Burnham Large Grid, consisted of 44 transects covering 11.25m with a transect interval of 25 cm. Burnham Small Grid covered 7m and contained 14 transects with a transect interval of 25cm. The large survey grid began at the 50 cm mark and traveled north then south alternately (Figure 64, 65 and 66). The smaller survey also began at the 50cm mark and headed north then south alternately with a deviation at transect 50 that continued to the end of the survey where all transects were surveyed in a southern direction.

Burnham Cemetery Large Grid

Transect	Transect Direction	Time/ns	Distance/m	Depth/cm	Interpretation
2	S	9.8	5.2	60	
		17.2	7.6	105	
		12.2	9.6	75	
		10.6	13.1	65	
		6.6	19.8	40	
		9.5	28.6	58	
		8.2	32.3	50	

5	N	9	4.4	55	
		12.9	10.8	79	
		12.4	18.1	76	
		12.2	21.5	75	
		10.6	22.7	65	
		10	24.8	61	
6	S	10.6	5.8	65	
		7.9	6.8	48	
		6.9	12.8	42	
		7.9	18.7	48	
		11.1	20.2	68	
		7.4	28.1	45	
7	N	11.6	8.8	71	
		11.4	10.7	70	
		10.3	17.9	63	
		10.8	25	66	
11	N	11.4	7.5	70	
		10.3	10.6	63	
		10.3	15	63	
		10	24.8	61	

13	N	12.7	7.6	78	
		9.8	10.8	60	
		10.6	12.1	65	
14	S	8.5	1.2	52	
		8.7	2.3	53	
		8.7	8.0	53	
		10.3	11.8	63	
		13.5	23.5	83	
18	S	8.2	3.8	50	
20	S	9.2	12	56	
		10.6	16.9	65	
		8.7	22.5	53	
		8.5	23.5	52	
21	N	10.6	7.4	65	
		9.5	8.9	58	
22	S	10.6	6.2	65	
		10.6	22.9	65	
25	N	8.2	7.9	50	
		10.6	24.5	65	

26	S	10	6.6	61	
		7.4	22.9	45	
27	N	16.1	2.4	99	
		12.7	7.2	78	
		7.1	12.3	43	
28	S	8.7	17.5	53	
		8.7	19.1	53	
		8.5	23.4	52	
		15.6	29	96	
29	N	15.1	2.1	92	
		9	7.6	55	
		6.9	12.1	42	
		7.1	13.5	43	
31	N	8.7	7.7	53	
32	S	8.7	23.6	53	
		11.1	29.7	68	
35	N	10	7.5	61	

36	S	11.1	5.8	68	
		7.4	9.1	45	
		11.6	24.7	71	
37	N	9	4.2	55	
		10.6	6.7	65	
		6.6	21.5	40	
		6.6	24	40	
38	S	9.8	7.5	60	
		12.2	24.5	75	
39	N	8.2	3.6	50	
		10.8	6.4	66	
40	S	10.3	25	68	
		8.5	27.6	50	
41	N	7.7	3.5	47	
		11.6	6.1	71	
		9.2	10	56	
42	S	11.1	24.7	68	
		8.2	27.3	50	

43	N	9	3.3	55	
		11.1	5.6	68	
		10.3	9.6	63	
		8.7	23.9	53	

Burnham Small Grid

Transect	Transect Direction	Location (m) of Anomalies	Depth (cm)	Disturbance
45-58	N-S	No anomalies	-	-

APPENDIX N: GENEALOGY OF CEMETERIES ON CCAFS

Genealogy and Burials at Cape Road Cemetery, Canaveral Air Force Station

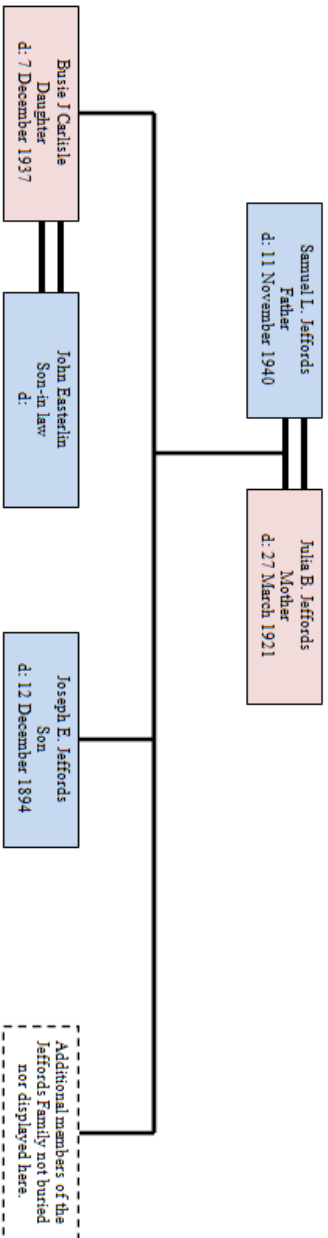

† Hubert W. Syfrett
Brother-in-law

† This individual is the brother of Samuel L. Jeffords 3rd wife,
Lillian C. (Syfrett) Jeffords

Genealogy and Burials at Cape Road Cemetery, Canaveral Air Force Station

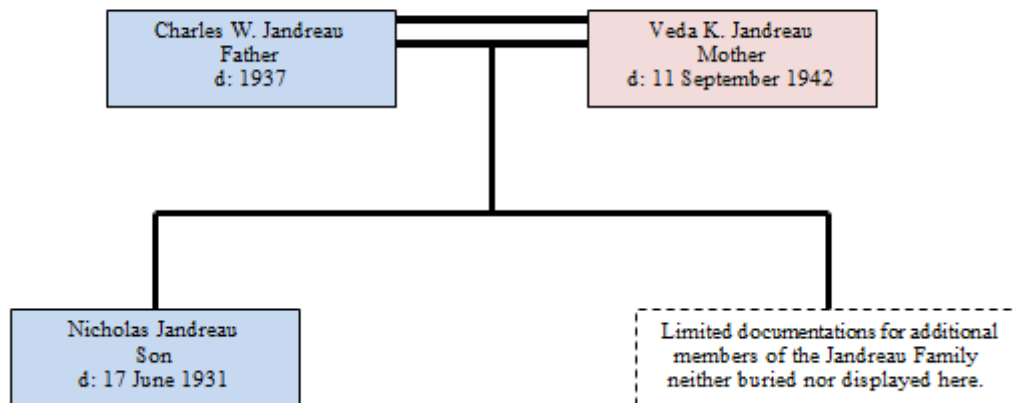

Genealogy and Burials at Cape Road Cemetery, Canaveral Air Force Station

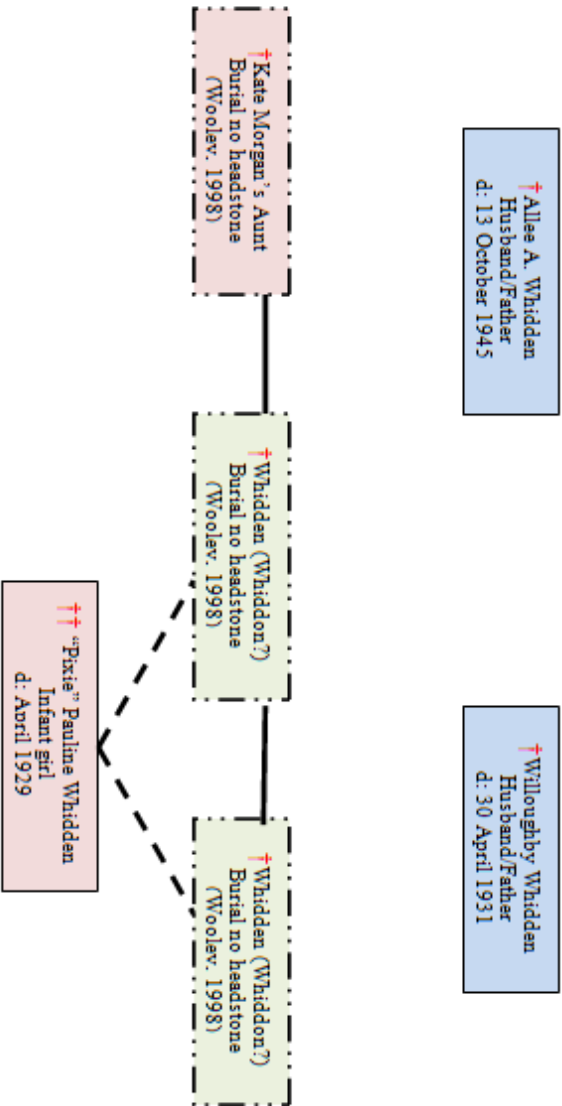

† Sources indicate the potential for a relationship. Allee and Willoughby were married but their spouses and descendants were not buried at Cape Road Cemetery and were not displayed. Sources also indicate that the purported burials were Whiddons though the spelling of the name recorded is Whiddon (NPS, 1984; Woolav, 1998).

†† Possible relationship to the indicated Whiddon burials or a separate complete burial

Genealogy and Burials at Cape Road Cemetery, Canaveral Air Force Station

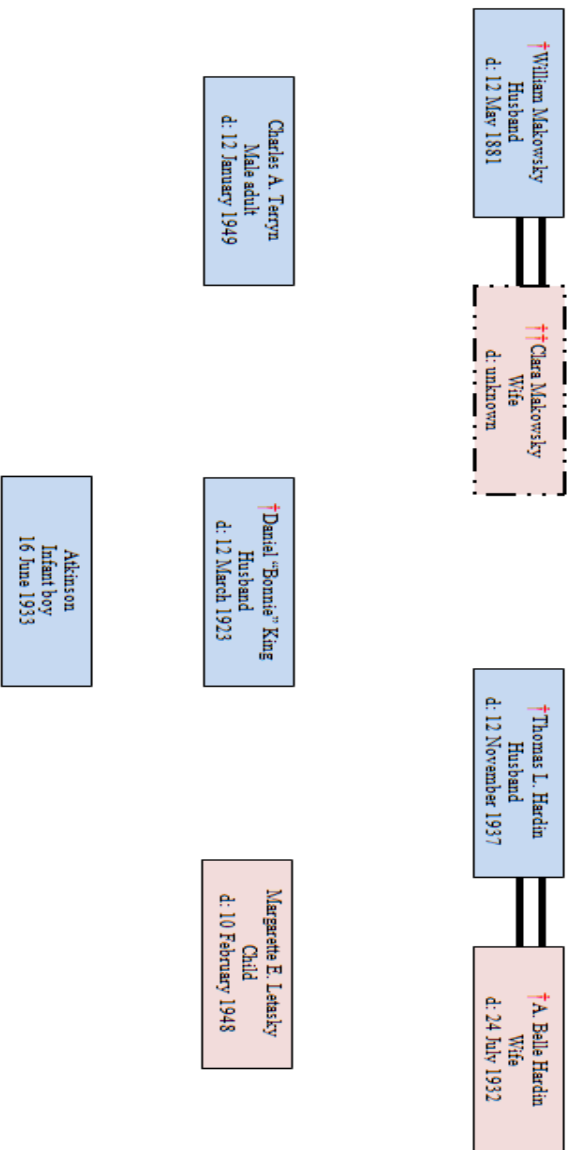

† There additional members of the Makowsky and Hardin families but there are no records for burials nor are they displayed at Cape Road Cemetery and were not displayed (NPS, 1984; Woolley, 1998).

†† Believed to be buried beside her husband (Woolley, 1998)

Genealogy and Burials at Quarterman South Cemetery, Canaveral Air Force Station

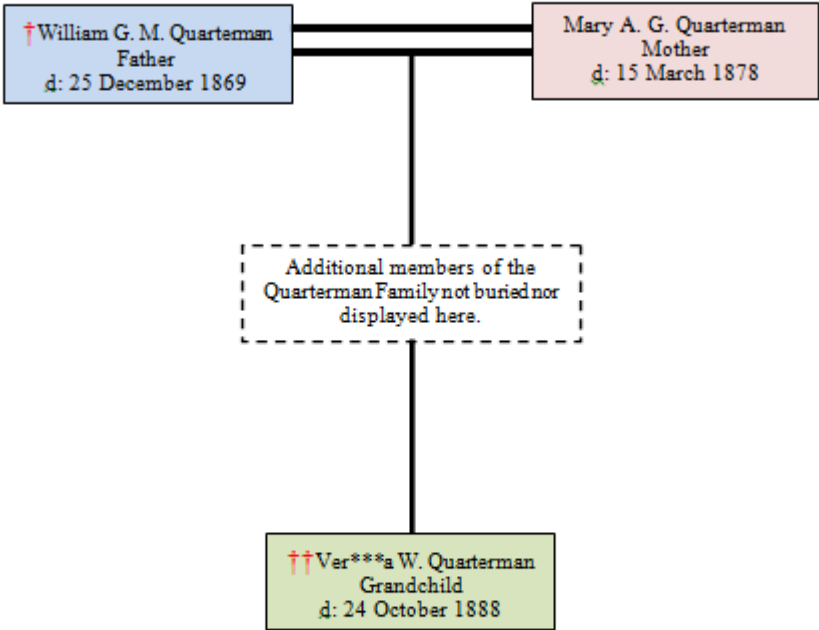

† Family recollection that the Patriarch of the Quarterman Family was buried in Quarterman South with his wife

†† A inconclusive documentation regarding the name and sex of this infant

Genealogy and Burials at Burnham Cemetery, Canaveral Air Force Station

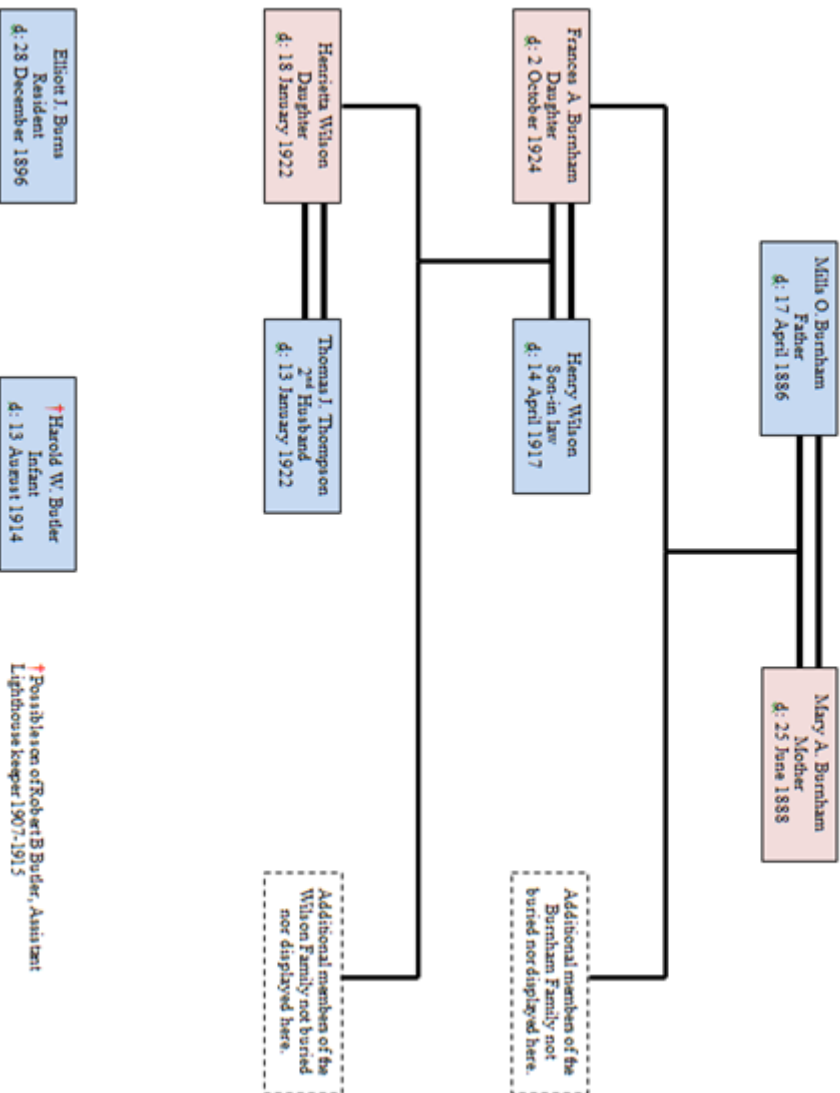

**APPENDIX O: DATA COLLECTION AND PROCESSING ISSUES,
CCAFS**

Cape Road Cemetery: The survey was conducted on two consecutive days. The reason for the two distinctive maps lies with bad transects. In conducting the survey hardware breakdown contributed to corrupted data being entered into the survey data set. This in turn led to a break in the sequence the GPR unit recorded of the transects. The only way to create a viable horizontal slice map was to eliminate the corrupted transect data. This was accomplished by filtering the good transect data from the bad. Starting at the beginning of the survey successive horizontal slice Horizontal Slices were propagated until bad transects were encountered. At that time a horizontal slice map was generated for the good transects. The process was repeated for the transects at the end of the survey. There were a number of bad files that were removed during the processing that produced the horizontal slice overview. The initial attempt to create a combined and complete horizontal slice overview proved unsuccessful. Doing the processing for each day's survey did produce a horizontal slice overview so post-processing analysis was conducted on each survey. These in turn were compared with the point plot mapping of the survey.

Cape Road Cemetery Grid 2: Bad data was in essence transects that were halted during survey because of technical difficulties with the computer or GPR unit. Both required removal of bad transects for macro processing and similar issues occurred in the horizontal slice mapping as Cape Road Cemetery Day 1 and 2. Survey CRC Grid 2 (.5) m produced a horizontal slice overview as two distinct maps of unequal size. The reason for the two distinctive maps lies with bad transects. In conducting the survey hardware breakdown contributed to corrupted data being entered into the survey data set. This in turn led to a break in the sequence the GPR unit recorded

of the transects. The only way to create a viable horizontal slice map was to eliminate the corrupted transect data. This was accomplished by filtering the good transect data from the bad. Starting at the beginning of the survey successive horizontal slice Horizontal Slices were propagated until bad transects were encountered. At that time a horizontal slice map was generated for the good transects. The process was repeated for the transects at the end of the survey. In the case Cape Road the resulting horizontal slice maps were compared with survey point plot maps to complete the analysis for GPR survey of the cemetery.

Quarterman South Cemetery: All grids had “bad” data that was removed from the processing that generated the horizontal slice overview. In the case of Grid 3 data was adjusted due to operator error that duplicated transects. The processing to correct this issue in Grid 3 led to a single horizontal slice overview being produced. Like the processing done on Cape Road Cemetery and CRC Grid 2, a horizontal slice cube could only be generated when all transects were aligned correctly with each other. If the transect was not aligned, in the software, with the one before it a horizontal slice overview did not generate. To troubleshoot this problem transects were reverse processed until a viable horizontal slice overview was generated. This reverse processing of the grid pinpointed the discontinuity between transects. In the case of Grid 3 the discontinuity was caused by transect duplication. In removing the duplicate transect the processing of the remaining transects were treated as separate survey. Grid 3a horizontal slice cube covers the first 8 m of the grid and Grid 3b the remaining 7.3 m of the grid. Grid 2 produced a viable horizontal slice overview with minimal pre-processing of transects.

Quarterman North Cemetery: No processing or data problems observed.

Burnham Cemetery: No processing or data problems observed.

REFERENCES

- Anonymous 2007 GPR Reveals Battlefield. *Military History* 24(7):13-13.
- Anonymous 2010 The Landscape through the Eyes of a Gis. *Acta Archaeologica* 81(1):129-135.
- Baker, Brenda J.
2000 Beyond the massacre: historic and prehistoric activity at Fort William Henry. *Northeast anthropology* 60:45-61.
- Baxter, Carey L., Tad Britt, Dana Beehr.
2006 *Cultural Resources Evaluations of the Original Lighthouse Site (8BR234), the Cape Canaveral Lighthouse Site (8BR212), and the New Lighthouse Site (8BR1600), Cape Canaveral Air Force Station, Brevard County, Florida*, Submitted to: Commander, Patrick Air Force Base (45CES-CEV)
- Bennett, Matthew R., Nigel J. Cassidy, and Jeremy Pile
2009 Internal structure of a barrier beach as revealed by ground penetrating radar (GPR): Chesil beach, UK. *Geomorphology* 104(3-4):218-229.
- Bevan, B. W.
1991 The search for graves. *Geophysics* 56(9):1310.
- Bevan, Bruce, and Jeffrey Kenyon
1975 Ground-penetrating radar for historical archaeology. *MASCA newsletter* 11(2):2-7.
- Brooks, Gregg R., Larry J. Doyle, Richard A. Davis, Nancy T. DeWitt, and Beau C. Suthard
2003 Patterns and controls of surface sediment distribution: west-central Florida inner shelf. *Marine Geology* 200(1-4):307-324.
- Bruland, G. L., and C. J. Richardson
2005 Spatial Variability of Soil Properties in Created, Restored, and Paired Natural Wetlands. *Soil Science Society of America Journal* 69(1):273-284.
- Bruland, G. L., and C. J. Richardson
2005 Spatial Variability of Soil Properties in Created, Restored, and Paired Natural Wetlands. *Soil Science Society of America Journal* 69(1):273-284.

- Bocquet-Appel, Jean
2006 Testing the hypothesis of a worldwide Neolithic demographic transition :corroboration from American cemeteries. *Current anthropology* 47(2):341-365.
- Böniger, U., and J. Tronicke
2010 Improving the interpretability of 3D GPR data using target-specific attributes: application to tomb detection. *Journal of Archaeological Science* 37(2):360-367.
- Buzon, Michele R.
2005 Health and disease in nineteenth-century San Francisco :skeletal evidence from a forgotten cemetery. *Historical archaeology* 39(2):1-15.
- Buzon, Michele R.
2006 Health of the Non-Elites at Tombos: Nutritional and Disease Stress in New Kingdom Nubia. *American Journal of Physical Anthropology* 130(1):26-37.
- Cantley, Charles E., Mary Beth Reed, Leslie Raymer, Joe Joseph, Ph.D., Nancy Lorenz, Julie Cantley, Tracey Fedor
1994 Historic Properties Survey Cape Canaveral Air Force Station, Brevard County, Florida. Contract Number DACA01-91-D-0031
- Carlson, Erik D.
2010 The Sunshine Economy: An Economic History of Florida since the Civil War. *Journal of Southern History* 76(4):1027-1028.
- Chapman, Henry, Jimmy Adcock, and John Gater
2009 An approach to mapping buried prehistoric palaeosols of the Atlantic seaboard in Northwest Europe using GPR, Geoarchaeology and GIS and the implications for heritage management. *Journal of Archaeological Science* 36(10):2308-2313.
- Cape Canaveral Image, www.nps.gov 2014
- Childers, Ronald Wayne
2004 The Presidio System in Spanish Florida 1565-1763. *Historical Archaeology* 38(3, Presidios of the North American Spanish Borderlands):pp. 24-32.
- Connolly, Thomas J.
2010 The archaeology of a pioneer family cemetery in western Oregon, 1854-1879. *Historical archaeology* 44(4):28-45.

- Conyers, Lawrence B.
2013 *Ground-Penetrating Radar for Archaeology*. 3rd ed. Alta Mira Press, Lanham, Maryland
- Conyers, Lawrence
2012 *Interpreting Ground-penetrating Radar for Archaeology*. Left Coast Press, Inc., Walnut Creek, California
- Conyers, Lawrence
2010 Ground-Penetrating Radar for Anthropological Research. *Antiquity* 84(323):175-184.
- Conyers, Lawrence B.
2006a Ground-penetrating radar techniques to discover and map historic graves. *Historical archaeology* 40(3):64-73.
- Conyers, Lawrence B.
2006b Innovative ground-penetrating radar methods for archaeological mapping. *Archaeological prospection* 13(2):139-141.
- Conyers, Lawrence B., and Malcom Corey
2002 Evidence for the African Cemetery at Higgs Beach, Key West, Florida. *Key West, FL: Mel Fisher Heritage Society*
- Cusick, James Gregory
1995 The Importance of the Community Study Approach in Historical Archaeology, with an Example from Late Colonial St. Augustine. *Historical Archaeology* 29(4):pp. 59-83.
- da Silva Cezar, Glória, Paula L. Ferrucio da Rocha, Angela Buarque, and Arioaldo da Costa
2001 Two Brazilian archaeological sites investigated by GPR: Serrano and Morro Grande. *Journal of Applied Geophysics* 47(3-4):227-240.
- Davis Jr., Richard A., Kristin E. Yale, John M. Pekala, and Megan V. Hamilton
2003 Barrier island stratigraphy and Holocene history of west-central Florida. *Marine Geology* 200(1-4):103.
- Davis, III, S., Jayc E. Cable, Daniel L. Childers, Carlos Coronado-Molina, Jr Day John W., Clinton D. Hittle, Christopher J. Madden, Enrique Reyes, David Rudnick, and Fred Sktar
2004 Importance of Storm Events in Controlling Ecosystem Structure and Function in a Florida Gulf Coast Estuary. *Journal of Coastal Research* 20(4):1198-1208.

- Deagan, Kathleen A.
1988 Neither History nor Prehistory: The Questions that Count in Historical Archaeology. *Historical Archaeology* 22(1):pp. 7-12.
- Deagan, Kathleen
1985 Spanish-Indian Interaction in Sixteenth Century Florida and Hispaniola. *Cultures in Contact*. William W.Fitzhugh, Ed.:281-318.
- Deagan, Kathleen
2004 Reconsidering Taíno Social Dynamics After Spanish Conquest: Gender and Class in Culture Contact Studies. *American Antiquity* 69(4):597-626.
- Dethlefsen, Edwin S.
Eighteenth century cemeteries:a demographic view. *Historical archaeology*, 1967. :40-42.
- Dickens, Roy S.
1979 Preliminary report on archaeological investigations in Oakland Cemetery, Atlanta, Georgia. *Conference on Historic Site Archaeology papers, 1978*. 13:286-314
- Doolittle, James A., and Nicholas F. Bellantoni
2010 The search for graves with ground-penetrating radar in Connecticut. *Journal of Archaeological Science* 37(5):941-949.
- Doolittle, J. A., F. E. Minzenmayer, S. W. Waltman, E. C. Benham, J. W. Tuttle, and S. D. Peaslee
2007 Ground-penetrating radar soil suitability map of the conterminous United States. *Geoderma* 141(3):416-421.
- Dunnivant, Justin
2012 Urban Development, Cemeteries, and a Need to Remember.
- Ebert, David
2004 Applications of Archaeological GIS. *Canadian Journal of Archaeology* 28(2):319-341
- EnviroPhysics, Inc.
2015 Tank Void, image, <http://www.envirophysics.com> 6 November 2015
- Feldman, Jackie
2007 Between Yad Vashem and Mt. Herzl :changing inscriptions of sacrifice on Jerusalem's "Mountain of Memory". *Anthropological quarterly* 80(4):1147-1174..

- Fiedler, Sabine, Bernhard Illich, Jochen Berger, and Matthias Graw
2009 The effectiveness of ground-penetrating radar surveys in the location of unmarked burial sites in modern cemeteries. *Journal of Applied Geophysics* 68(3):380-385.
- Finnegan, Erin
2011 The 'informal' burial ground at Prestwich Street, Cape Town : cultural and chronological indicators for the historical Cape underclass. *South African archaeological bulletin* 66(194):136-148.
- Florida Climate Center.
2015 Office of the State Climatologist. <http://climatecenter.fsu.edu/> 2 October 2015
- Gaffney, C.
2008 Detecting Trends in the Prediction of the Buried Past: a Review of Geophysical Techniques in Archaeology. *Archaeometry* 50(2):313-336.
- Geleta, S. B.
2014 Cemeteries as indicators of post-settlement anthropogenic soil degradation on the Atlantic coastal plain. *Human Ecology* 42(4):625-635.
- Geoscanners AB
2014, <http://www.geoscanners.com/about.htm>, 23 July 2014.
- Guo, Li, Jin Chen, Xihong Cui, Bihang Fan, and Henry Lin
2013 Application of ground penetrating radar for coarse root detection and quantification: a review. *Plant & Soil* 362(1):1-23.
- Guo, Li, Henry Lin, Bihang Fan, Xihong Cui, and Jin Chen
2013 Forward simulation of root's ground penetrating radar signal: simulator development and validation. *Plant & Soil* 372(1):487-505.
- Hally, David J.
2004 Mortuary Patterns at a Sixteenth-Century Town in Northwestern Georgia. *Southeastern Archaeology* 23(2):166-177.
- Hansen, James D., Jamie K. Pringle, and Jon Goodwin
2014 GPR and bulk ground resistivity surveys in graveyards: Locating unmarked burials in contrasting soil types. *Forensic science international* 237:e14-e29.

Hay, Michelle

2011 'The last thing that tells our story: the Roodepoort West Cemetery, 1958-2008. *Journal of southern African studies* 37(2):297-311.

Hegmon, Michelle

2003 Setting Theoretical Egos Aside: Issues and Theory in North American Archaeology. *American Antiquity* 68(2):pp. 213-243.

Heisey, Henry W.

1962 Of historic Susquehannock cemeteries, *Pennsylvania archaeologist*. :99-130.

Hepner, Tiffany L., and Richard A. Davis Jr.

2004 Effect of El Niño (1997-98) on Beaches of the Peninsular Gulf Coast of Florida. *Journal of Coastal Research* 20(3):776-791.

Huckle, Horace F., Hershel D. Dollar, Robert F. Pendleton

1971 Soil survey of Brevard County, Florida, United States Department of Agriculture, Soil Conservation Service, in cooperation with University of Florida, Agricultural Experiment Stations. <http://ufdc.ufl.edu/UF00026071/00001> accessed 15 May 2015.

Jaselskis, Edward J., Clifford J. Schexnayder, Christine Fiori, Timothy C. Becker, Wu-Chueh Hung, Christine Beckman, Manop Kaewmorachoen, Gerardo C. Recavarren, Manuel Celaya, and Daniela Alarcon

2013 Innovative Technologies Used to Investigate Segments of the Inca Road. *Journal of Professional Issues in Engineering Education & Practice* 139(3):187-195.

Kelble, Christopher R., Elizabeth M. Johns, William K. Nuttle, Thomas N. Lee, Ryan H. Smith, and Peter B. Ortner

2007 Salinity patterns of Florida Bay. *Estuarine Coastal & Shelf Science* 71(1):318-334.

Kersel, Morag

2009 Archaeological heritage and ethics. *Journal of field archaeology* 34(2):195-206.

Kersel, Morag, and Christina Luke

2009 Editorial Introduction: Archaeology and Development. *Journal of Field Archaeology* 34(2):195-196.

Kennedy, Joseph C. G.

1864 Population of The United States in 1860; Compiled from the Original Returns of the Eight Census under the Direction of the Secretary of the Interior
<https://archive.org/details/populationofusin00kennrich> accessed 28 October 2015

King, Julia A., and Bruce W. Bevan

1993 The reliability of geophysical surveys at historic-period cemeteries: An example from the plains. *Historical Archaeology* 27(3):4.

Lazarus, Steven M.

2009 Florida's Climate: Past, Present, and Future. *AIP Conference Proceedings* 1157(1):32-38.

Levy, Richard S., David F. Barton, Timothy B. Riordan

1984 *An Archeological Survey of Cape Canaveral Air Force Station, Brevard County Florida*, Submitted to National Park Services, Southeastern Regional

Liebens, Johan

2003 Map and Database Construction for an Historic Cemetery: Methods and Applications. *Historical Archaeology* 37(4):pp. 56-68.

Locker, Stanley D., Albert C. Hine, and Gregg R. Brooks

2003 Regional stratigraphic framework linking continental shelf and coastal sedimentary deposits of west-central Florida. *Marine Geology* 200(1-4):351.

Lovejoy, D. W.

1992, Classic exposures of the Anastasia Formation in Martin and Palm Beach Counties, Florida: Guidebook for combined Southeastern Geological Society and Miami Geological Society field trip, 31p.

Lynch, Michael W.

1999 Grave Problem. *Reason* 31(3):13.

Mainfort, Robert C.

1985 Wealth, space, and status in a historic Indian cemetery. *American antiquity* 50(3):555-579.

MALÅ GPR

2011 MALÅ X3M. <http://www.malags.com/Products>

Mealor Jr., W. T., and Merlie C. Prunty

1976 Open-Range Ranching in Southern Florida. *Annals of the Association of American Geographers* 66(3):360-376.

Mckiernan, Zachary

2011 *Get in the Spirit at St. Michael's Cemetery, NCPH Annual Meeting, April 9, 2011, Pensacola, Florida. St. Michael's Cemetery Foundation of Pensacola, Inc. and University of West Florida, sponsors. Vol. 33,*

Neal, Adrian

2004 Ground-penetrating radar and its use in sedimentology: principles, problems and progress. *Earth-Science Reviews* 66(3-4):261-330.

Nishimura, Yoko

2007 The North Mesopotamian Neighborhood: Domestic Activities and Household Space at Titris Höyük. *Near Eastern Archaeology* 70(1):53-56.

Olexa, Michael T., Nancy C. Hodge, Tracey L. Owens, and Caycee D. Hampton

2012 A Grave Situation: Protecting the Deceased and Their Final Resting Places from Destruction. *Florida Bar Journal* 86(9):35-42.

Otto, John Solomon

1986 Open-Range Cattle-Ranching in the Florida Pinewoods: A Problem in Comparative Agricultural History. *Proceedings of the American Philosophical Society* 130(3):pp. 312-324.

Peterson, Rick

2013 Social memory and ritual performance. *Journal of social archaeology* 13(2):266-283.

Pettinelli, Elena, Pier M. Barone, Elisabetta Mattei, and Sebastian E. Lauro

2011 Radio wave techniques for non-destructive archaeological investigations. *Contemporary Physics* 52(2):121-130.

Pfannkuche, Craig

2003 Gillilan Cemetery Investigations Mchenry County, Illinois. *Illinois Antiquity* 38(1):9-11.

Porsani, Jorge L.

2010 GPR survey at Lapa do Santo archaeological site, Lagoa Santa karstic region, Minas Gerais state, Brazil. *Journal of archaeological science* 37(6):1141-1148.

Porter, Kenneth Wiggins

1943 Florida Slaves and Free Negroes in the Seminole War, 1835-1842. *The Journal of Negro History* 28(4):pp. 390-421.

Rainville, Lynn

2009 Protecting our shared heritage in African-American cemeteries. *Journal of field archaeology* 34(2):195-206.

Ren, R. -, Ming Cai, Chunyi Xiang, and Guoxiong Wu

2012 Observational evidence of the delayed response of stratospheric polar vortex variability to ENSO SST anomalies. *Climate Dynamics* 38(7):1345-1358.

Rey, Jorge R.

2010 Florida Cracker Cattle, AN240. Animal Sciences Department, Florida Cooperative Extension Service, Institute of Food And Agricultural Sciences, University of Florida, <http://edis.ifas.ufl.edu>

Riordan, Timothy R., and Ruth M. Mitchell

2011 Eighteenth- and Nineteenth- Century Brick-Lined Graves: Their Construction and Chronology. *Historical Archaeology* 45(4):91-101.

Rodrigues, Selma I., Jorge L. Porsani, Vinicius R. N. Santos, Paulo A. D. DeBlasis, and Paulo C. F. Giannini

2009 GPR and inductive electromagnetic surveys applied in three coastal sambaqui (shell mounds) archaeological sites in Santa Catarina state, South Brazil. *Journal of Archaeological Science* 36(10):2081-2088.

Ruffell, Alastair, Alan McCabe, Colm Donnelly, and Brian Sloan

2009 Location and Assessment of an Historic (150–160 Years Old) Mass Grave Using Geographic and Ground Penetrating Radar Investigation, NW Ireland. *Journal of Forensic Sciences (Wiley-Blackwell)* 54(2):382-394.

Rugg, Julie

2013 Constructing the grave: competing burial ideals in nineteenth-century England*. *Social History* 38(3):328-345.

Ruhl, Donna L.

1997 Oranges and Wheat: Spanish Attempts at Agriculture in La Florida. *Historical Archaeology* 31(1, Diversity and Social Identity in Colonial Spanish America: Native American, African, and Hispanic Communities during the Middle Period):pp. 36-45.

Sandweiss, Daniel H., Alice R. Kelley, Daniel F. Belknap, Joseph T. Kelley, Kurt Rademaker, and David A. Reid

2010 GPR identification of an early monument at Los Morteros in the Peruvian coastal desert. *Quaternary Research* 73(3):439-448.

- Sattenspiel, Lisa, and Melissa Stoops
2010 Gleaning Signals About the Past From Cemetery Data. *American Journal of Physical Anthropology* 142(1):7-21.
- Scarry, John F., and Bonnie G. McEwan
1995 Domestic Architecture in Apalachee Province: Apalachee and Spanish Residential Styles in the Late Prehistoric and Early Historic Period Southeast. *American Antiquity* 60(3):pp. 482-495.
- Schmaizer, Paul A., G. Ross Hinkle,
1990 *Geology, Geohydrology and Soils of Kennedy Space Center, A Review*, The Bionetics Corporation, Submitted to NASA and Kennedy Space Center. Contract No. NAS10-10285 and NAS10-11624. Unlimited, NTIS.
- Schmelzbach, C., J. Tronicke, and P. Dietrich
2011 Three-dimensional hydrostratigraphic models from ground-penetrating radar and direct-push data. *Journal of Hydrology* 398(3-4):235-245.
- Schmidt, Nancy, E. K. Lipp, J. B. Rose, and M. E. Luther
2001 ENSO Influences on Seasonal Rainfall and River Discharge in Florida. *Journal of Climate* 14(4):615.
- Schultz, John J., and Michael M. Martin
2011 Controlled GPR grave research: Comparison of reflection profiles between 500 and 250 MHz antennae. *Forensic science international* 209(1-3):64-69.
- Schultz, John J., and Michael M. Martin
2012 Monitoring controlled graves representing common burial scenarios with ground penetrating radar. *Journal of Applied Geophysics* 83(0):74-89.
- Scott, Thomas M. P.G.
2001 #99, Text to Accompany the Geologic Map of Florida, Open-file Report 80, Florida Geological Survey.
- Sellers, E. H.
1912, The soils and other surface residual materials of Florida: Florida Geological Survey Fourth Annual Report, p. 1-79.
- Sellevoid, Berit J.
2008 Archaeological bones : the anatomy of an abandoned churchyard. *Norwegian archaeological review* 41(1):71-84.

- Smith, Anthony J., David E. Herne, and Jeffrey V. Turner
2009 Wave effects on submarine groundwater seepage measurement. *Advances in Water Resources* 32(6):820-833.
- Smith, David A.
2012 Ground penetrating radar (GPR) survey, Wakulla Springs State Park, Wakulla County, Florida: use of GPR in support of archaeology. *Florida anthropologist* 65(1-2):33-40.
- Smith, Shawn R., Justin Brolley, James J. O'Brien, and Carissa A. Tartaglione
2007 ENSO's Impact on Regional U.S. Hurricane Activity. *Journal of Climate* 20(7):1404-1414.
- Sutton, Mary-Jean
2013 Understanding cultural history using ground-penetrating radar mapping of unmarked graves in the Mapoon Mission cemetery, western Cape York, Queensland, Australia. *International journal of historical archaeology* 17(4):782-805.
- Tanikawa, Toko, Yasuhiro Hirano, Masako Dannoura, Keitarou Yamase, Kenji Aono, Masahiro Ishii, Tetsuro Igarashi, Hidetoshi Ikeno, and Yoichi Kanazawa
2013 Root orientation can affect detection accuracy of ground-penetrating radar. *Plant & Soil* 373(1):317-327.
- Ubelaker, Douglas, H.
1995 Historic cemetery analysis: Practical considerations. *Bodies of Evidence: Reconstructing History Through Skeletal Analysis*, Wiley-Liss, New York :37-48.
- Under, M., H. Lorenzo, F. I. Rial, and A. Novo
2011 GPR evaluation of the Roman masonry arch bridge of Lugo (Spain). *NDT & E International* 44(1):8-12.
- Underberg, Natalie M.
2006 Virtual and Reciprocal Ethnography on the Internet: The East Mims Oral History Project Website. *Journal of American Folklore* V 119(473):301-311.
- United States Geologic Service.
2015 USGS Groundwater Information Pages Website. <http://www.usgs.gov/water>
- Wardlaw, D.
2009 Geophysical Survey of Greenwood Cemetery, Orlando, Florida. Master's thesis, Department of Anthropology, University of Central Florida, Orlando.

- Wayman, Erin
2011 *Gis. Earth (1943345X)* 56(1):26-33.
- Weaver, Wendy
2006 Ground-Penetrating Radar Mapping in Clay: Success from South Carolina, USA. *Archaeological Prospection* 13(2):147-150.
- Weisman, Brent R.
2003 Why Florida Archaeology Matters. *Southeastern Archaeology* 22(2):210-226.
- Wentworth, Charles M. and Violet B. Wentworth
2000 *Lesser-Known Pioneer Cemeteries of Brevard C., Florida* Vol. 2 Dogwood Printing, Ozark, MO
- Whiting, Brian M., Douglas P. McFarland, and Steven Hackenberger
2001 Three-dimensional GPR study of a prehistoric site in Barbados, West Indies. *Journal of Applied Geophysics* 47(3-4):217-226.
- Wooley, R
1998 *History of Cape Canaveral and The Early Settlers*
- Wu, Yuan, Li Guo, Xihong Cui, Jin Chen, Xin Cao, and Henry Lin
2014 Ground-penetrating radar-based automatic reconstruction of three-dimensional coarse root system architecture. *Plant & Soil* 383(1):155-172.
- Wunderlin, R. P., and B. F. Hansen. 2008. *Atlas of Florida Vascular Plants* (<http://florida.plantatlas.usf.edu/>). [S. M. Landry and K. N. Campbell (application development), Florida Center for Community Design and Research.] Institute for Systematic Botany, University of South Florida, Tampa, accessed October 28, 2014
- Yerkes, Richard W.
2005 Bone Chemistry, Body Parts, and Growth Marks: Evaluating Ohio Hopewell and Cahokia Mississippian Seasonality, Subsistence, Ritual, and Feasting. *American Antiquity* 70(2):241-265.